

SN54LS422, SN54LS423, SN74LS422, SN74LS423 RETRIGGERABLE MONOSTABLE MULTIVIBRATORS

SDLS175 D2536, JANUARY 1980 — REVISED MARCH 1988

- Will Not Trigger from Clear
- D-C Triggered from Active-High or Active-Low Gated Logic Inputs
- Retriggerable for Very Long Output Pulses, Up to 100% Duty Cycle
- Overriding Clear Terminates Output Pulse
- 'LS422 Has Internal Timing Resistor

description

The 'LS422 and 'LS423 are identical to 'LS122 and 'LS123 except they cannot be triggered via clear.

These d-c triggered multivibrators feature output-pulse-width control by three methods. The basic pulse time is programmed by selection of external resistance and capacitance values (see typical application data). The 'LS422 contains an internal timing resistor that allows the circuits to be used with only an external capacitor, if so desired. Once triggered, the basic pulse width may be extended by retriggering the gated low-level-active (A) or high-level-active (B) inputs, or be reduced by use of the overriding clear. Figure 1 illustrates pulse control by retriggering and early clear.

The 'LS422 and 'LS423 have enough Schmitt hysteresis to ensure jitter-free triggering from the B input with transition rates as slow as 0.1 millivolt per nanosecond. The 'LS422 R_{int} is nominally 10 k ohms.

The SN54LS422 and SN54LS423 are characterized for operation over the full military temperature range of -55°C to 125°C . The SN74LS422 and SN74LS423 are characterized for operation from 0°C to 70°C .

SN54LS423 . . . J OR W PACKAGE
SN74LS423 . . . D OR N PACKAGE
(TOP VIEW) (SEE NOTES 1 THRU 4)

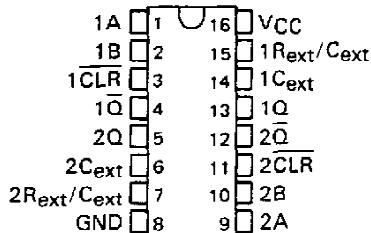

SN54LS422 . . . J OR W PACKAGE
SN74LS422 . . . D OR N PACKAGE
(TOP VIEW) (SEE NOTES 1 THRU 4)

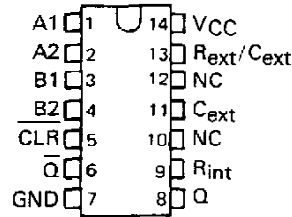

SN54LS422 . . . FK PACKAGE
(TOP VIEW) (SEE NOTES 1 THRU 4)

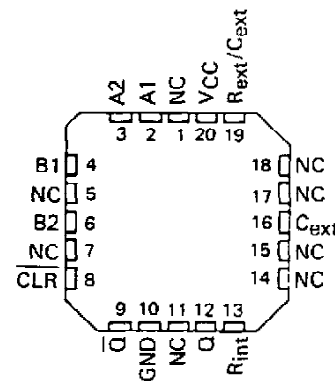

SN54LS423 . . . FK PACKAGE
(TOP VIEW) (SEE NOTES 1 THRU 4)

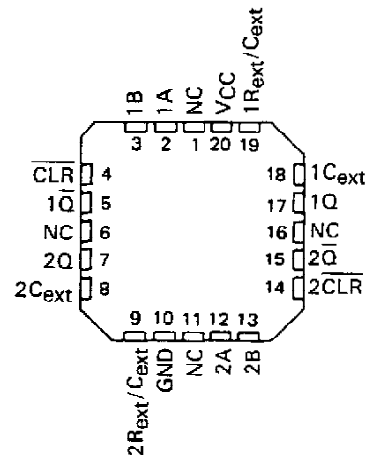

- NOTES: 1. An external timing capacitor may be connected between C_{ext} and R_{ext}/C_{ext} (positive).
 2. To use the internal timing resistor of 'LS422, connect R_{int} to V_{CC} .
 3. For improved pulse width accuracy and repeatability, connect an external resistor between R_{ext}/C_{ext} and V_{CC} with R_{int} open-circuited.
 4. To obtain variable pulse widths, connect an external variable resistance between R_{int} or R_{ext}/C_{ext} and V_{CC} .

PRODUCTION DATA documents contain information current as of publication date. Products conform to specifications per the terms of Texas Instruments standard warranty. Production processing does not necessarily include testing of all parameters.

TEXAS
INSTRUMENTS

POST OFFICE BOX 655012 • DALLAS, TEXAS 75265

SN54LS422, SN54LS423, SN74LS422, SN74LS423 RETRIGGERABLE MONOSTABLE MULTIVIBRATORS

description (continued)

| LS422 FUNCTION TABLE | | | | | | | LS423 FUNCTION TABLE | | | | | |
|-------------------------|----|----|----|----|----|-----------|-------------------------|--------|---|----|-----------|--|
| INPUTS | | | | | | OUTPUTS | | INPUTS | | | OUTPUTS | |
| CLEAR | A1 | A2 | B1 | B2 | Q | \bar{Q} | CLEAR | A | B | Q | \bar{Q} | |
| L | X | X | X | X | L | H | L | X | X | L | H | |
| X | H | H | X | X | L↑ | H↑ | X | H | X | L↑ | H↑ | |
| X | X | X | L | X | L↑ | H↑ | X | X | L | L↑ | H↑ | |
| X | X | X | X | L | L↑ | H↑ | H | L | ↑ | ↓ | ↑ | |
| H | L | X | ↑ | H | ↓ | ↑ | H | X | L | ↑ | H | |
| H | L | X | H | ↑ | ↓ | ↑ | H | X | L | H | ↑ | |
| H | X | L | ↑ | H | ↓ | ↑ | X | H | ↓ | H | H | |
| H | X | L | H | ↑ | ↓ | ↑ | X | ↓ | ↓ | H | H | |
| H | ↓ | ↓ | H | H | ↓ | ↑ | H | ↓ | H | H | H | |
| H | ↓ | H | H | H | ↓ | ↑ | H | ↓ | H | H | H | |

† These lines of the functional tables assume that the indicated steady-state conditions at the A and B inputs have been set up long enough to complete any pulse started before the set up.

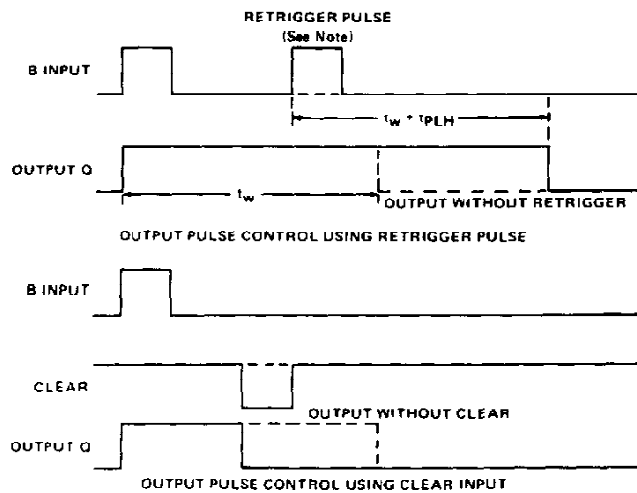

NOTE: Retrigger pulses starting before $0.22 C_{ext}$ (in picofrads) nanoseconds after the initial trigger pulse will be ignored and the output pulse will remain unchanged.

FIGURE 1—TYPICAL INPUT/OUTPUT PULSES

SN54LS422, SN54LS423, SN74LS422, SN74LS423 RETRIGGERABLE MONOSTABLE MULTIVIBRATORS

logic symbols†

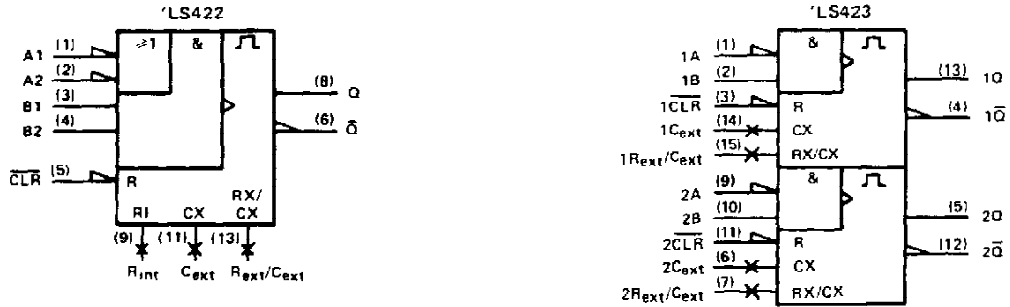

† These symbols are in accordance with ANSI/IEEE Std 91-1984 and IEC Publication 617-12.

logic diagrams (positive logic)

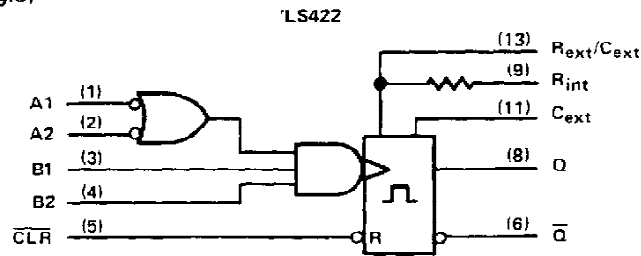

R_{int} is nominally 10 k ohms

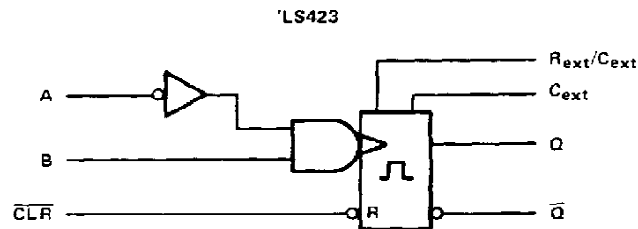

Pin numbers shown are for D, J, N, and W packages.

schematics of inputs and outputs

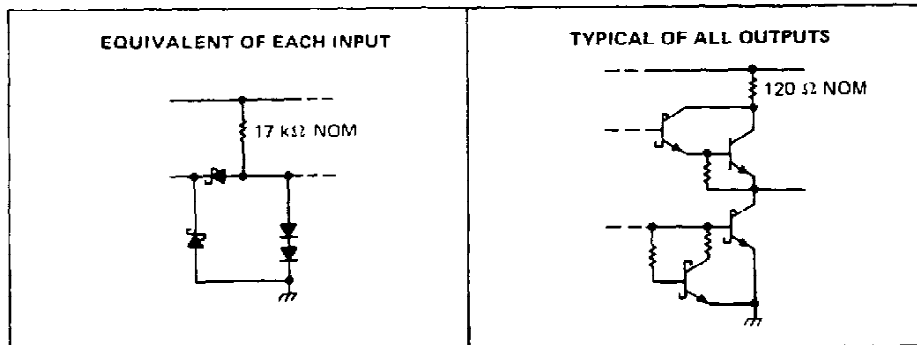

SN54LS422, SN54LS423, SN74LS422, SN74LS423 RETRIGGERABLE MONOSTABLE MULTIVIBRATORS

recommended operating conditions

| | SN54LS* | | | SN74LS* | | | UNIT |
|--|----------------|-----|------|----------------|-----|------|--------------|
| | MIN | NOM | MAX | MIN | NOM | MAX | |
| Supply voltage, V_{CC} | 4.5 | 5 | 5.5 | 4.75 | 5 | 5.25 | V |
| High-level output current, I_{OH} | | | -400 | | | -400 | μ A |
| Low-level output current, I_{OL} | | | 4 | | | 8 | mA |
| Pulse width, t_W | 40 | | | 40 | | | ns |
| External timing resistance, R_{ext} | 5 | | 180 | 5 | | 260 | k Ω |
| External capacitance, C_{ext} | No restriction | | | No restriction | | | |
| Wiring capacitance at R_{ext}/C_{ext} terminal | 50 | | | 50 | | | pF |
| Operating free-air temperature, T_A | -55 | | 125 | 0 | | 70 | $^{\circ}$ C |

electrical characteristics over recommended operating free-air temperature range (unless otherwise noted)

| PARAMETER | TEST CONDITIONS† | SN54LS* | | | SN74LS* | | | UNIT | |
|--|--|---------|------|-------------------------|---------|------|------|---------|-----|
| | | MIN | TYP‡ | MAX | MIN | TYP‡ | MAX | | |
| V_{IH} High-level input voltage | | 2 | | | 2 | | | V | |
| V_{IL} Low-level input voltage | | | | 0.7 | | | 0.8 | V | |
| V_{IK} Input clamp voltage | $V_{CC} = \text{MIN}$, $I_I = -18 \text{ mA}$ | | | -1.5 | | | -1.5 | V | |
| V_{OH} High-level output voltage | $V_{CC} = \text{MIN}$, $V_{IH} = 2 \text{ V}$, $V_{IL} = V_{IL \text{ max}}$, $I_{OH} = 400 \mu\text{A}$ | 2.5 | 3.5 | | 2.7 | 3.5 | | V | |
| V_{OL} Low-level output voltage | $V_{CC} = \text{MIN}$, $V_{IH} = 2 \text{ V}$, $V_{IL} = V_{IL \text{ max}}$ | | | 0.25 | 0.4 | | 0.25 | 0.4 | V |
| | | | | $I_{OL} = 4 \text{ mA}$ | | | 0.35 | | 0.5 |
| | | | | $I_{OL} = 8 \text{ mA}$ | | | | | |
| I_I Input current at maximum input voltage | $V_{CC} = \text{MAX}$, $V_I = 7 \text{ V}$ | | | 0.1 | | | 0.1 | mA | |
| I_{IH} High-level input current | $V_{CC} = \text{MAX}$, $V_I = 2.7 \text{ V}$ | | | 20 | | | 20 | μ A | |
| I_{IL} Low-level input current | $V_{CC} = \text{MAX}$, $V_I = 0.4 \text{ V}$ | | | -0.4 | | | -0.4 | mA | |
| I_{OS} Short-circuit output current § | $V_{CC} = \text{MAX}$ | -20 | | -100 | -20 | | -100 | mA | |
| I_{CC} Supply current (quiescent or triggered) | $V_{CC} = \text{MAX}$, See Note 6 | | | 6 | 11 | | 6 | 11 | mA |
| | | | | 'LS422 | | | | | |
| | | | | 'LS423 | | | 12 | | 20 |

† For conditions shown as MIN or MAX, use the appropriate value specified under recommended operating conditions.

‡ All typical values are at $V_{CC} = 5 \text{ V}$, $T_A = 25^{\circ}\text{C}$.

§ Not more than one output should be shorted at a time and duration of the short-circuit should not exceed one second.

NOTES: 5. To measure V_{OH} at Q, V_{OL} at \bar{Q} , or I_{OS} at Q, ground R_{ext}/C_{ext} , apply 2 V to B and clear, and pulse A from 2 V to 0 V.
6. With all outputs open and 4.5 V applied to all data and clear inputs, I_{CC} is measured after a momentary ground, then 4.5 V, is applied to clock.

switching characteristics, $V_{CC} = 5 \text{ V}$, $T_A = 25^{\circ}\text{C}$, see note 7

| PARAMETER¶ | FROM (INPUT) | TO (OUTPUT) | TEST CONDITIONS | MIN | TYP | MAX | UNIT |
|----------------------|--------------|-------------|---|-----|-----|-----|---------|
| t_{PLH} | A | Q | $C_{ext} = 0$, $R_{ext} = 5 \text{ k}\Omega$, $C_L = 15 \text{ pF}$, $R_L = 2 \text{ k}\Omega$ | | 23 | 33 | ns |
| | B | Q | | | 23 | 44 | |
| t_{PHL} | A | \bar{Q} | | | 32 | 45 | ns |
| | B | \bar{Q} | | | 34 | 56 | |
| t_{PHL} | Clear | Q | | | 20 | 27 | ns |
| t_{PLH} | Clear | \bar{Q} | | | 28 | 45 | ns |
| $t_{wQ}(\text{min})$ | A or B | Q | | 116 | 200 | ns | |
| t_{wQ} | A or B | Q | $C_{ext} = 1000 \text{ pF}$, $R_{ext} = 10 \text{ k}\Omega$, $C_L = 15 \text{ pF}$, $R_L = 2 \text{ k}\Omega$ | 4 | 4.5 | 5 | μ s |

¶ t_{wQ} = width of pulse output Q.

NOTE 7: Load circuits and voltage waveforms are shown in Section 1.

TEXAS
INSTRUMENTS

POST OFFICE BOX 655012 • DALLAS, TEXAS 75265

SN54LS422, SN54LS423, SN74LS422, SN74LS423 RETRIGGERABLE MONOSTABLE MULTIVIBRATORS

TYPICAL APPLICATION DATA FOR 'LS422, 'LS423†

The basic output pulse width is essentially determined by the values of external capacitance and timing resistance. For pulse widths when $C_{ext} \leq 1000$ pF, use Figure 3. For C_{ext} between 0.1 nF and 1 μ F, the pulse width may be defined as:

$$t_w \approx K \cdot R_T \cdot C_{ext}$$

with K obtained from Figure 4.

When $C_{ext} \geq 1$ μ F, the output pulse width is defined as:

$$t_w \approx 0.33 \cdot R_T \cdot C_{ext}$$

Where

R_T is in kilohms (internal or external timing resistance)

C_{ext} is in pF

t_w is in nanoseconds

For maximum noise immunity, system ground should be applied to the C_{ext} node, even though the C_{ext} node is already tied to the ground lead internally. Due to the timing scheme used by the 'LS422 and 'LS423, a switching diode is not required to prevent reverse biasing when using electrolytic capacitors.

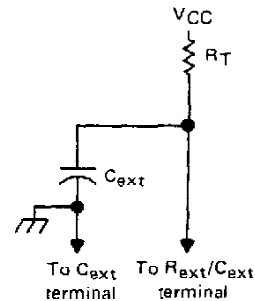

TIMING COMPONENT CONNECTIONS
FIGURE 2

'LS422, 'LS423 TYPICAL OUTPUT PULSE WIDTH vs EXTERNAL TIMING CAPACITANCE

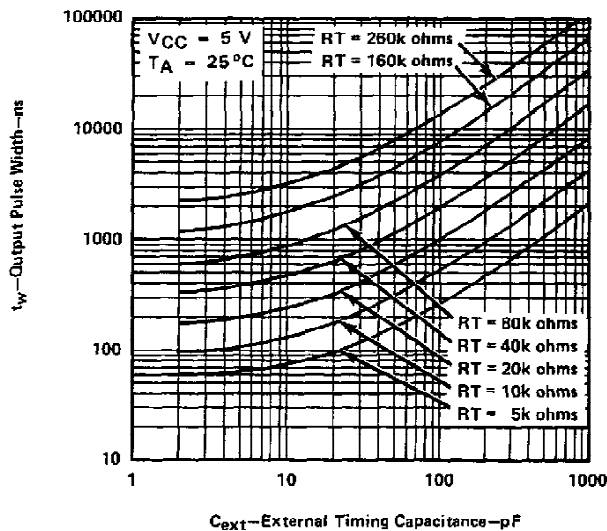

† This value of resistance exceeds the maximum recommended for use over the full temperature range of the SN54LS circuits.

FIGURE 3

TEXAS
INSTRUMENTS

POST OFFICE BOX 655012 • DALLAS, TEXAS 75265

**SN54LS422, SN54LS423, SN74LS422, SN74LS423
RETRIGGERABLE MONOSTABLE MULTIVIBRATORS**

TYPICAL APPLICATION DATA FOR 'LS422, 'LS423 †

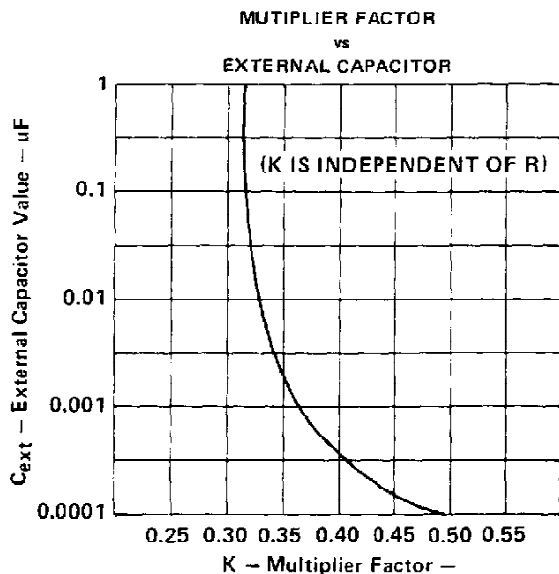

FIGURE 4

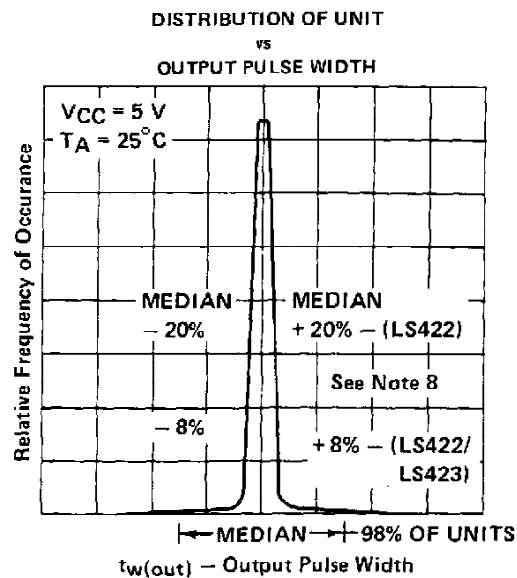

FIGURE 5

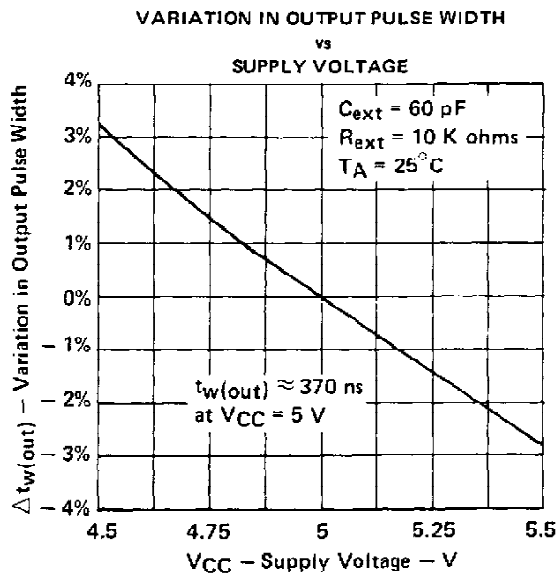

FIGURE 6

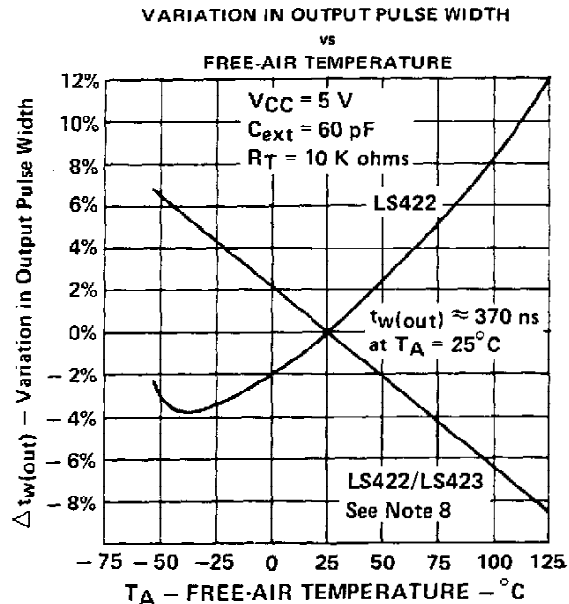

FIGURE 7

NOTE 8: For the LS422, the internal timing resistor, R_{int} was used. For the LS422/423, an external timing resistor was used for R_T.
† Data for temperatures below 0°C and above 70°C and for supply voltages below 4.75 V and above 5.25 V are applicable for SN54LS422 and SN54LS423 only.



TAPE AND REEL INFORMATION
REEL DIMENSIONS

TAPE DIMENSIONS

| | |
|----|---|
| A0 | Dimension designed to accommodate the component width |
| B0 | Dimension designed to accommodate the component length |
| K0 | Dimension designed to accommodate the component thickness |
| W | Overall width of the carrier tape |
| P1 | Pitch between successive cavity centers |

TAPE AND REEL INFORMATION

*All dimensions are nominal

| Device | Package Type | Package Drawing | Pins | SPQ | Reel Diameter (mm) | Reel Width W1 (mm) | A0 (mm) | B0 (mm) | K0 (mm) | P1 (mm) | W (mm) | Pin1 Quadrant |
|--------------|--------------|-----------------|------|------|--------------------|--------------------|---------|---------|---------|---------|--------|---------------|
| SN74LS423NSR | SO | NS | 16 | 2000 | 330.0 | 16.4 | 8.2 | 10.5 | 2.5 | 12.0 | 16.0 | Q1 |

TAPE AND REEL BOX DIMENSIONS

*All dimensions are nominal

| Device | Package Type | Package Drawing | Pins | SPQ | Length (mm) | Width (mm) | Height (mm) |
|--------------|--------------|-----------------|------|------|-------------|------------|-------------|
| SN74LS423NSR | SO | NS | 16 | 2000 | 367.0 | 367.0 | 38.0 |

IMPORTANT NOTICE

Texas Instruments Incorporated and its subsidiaries (TI) reserve the right to make corrections, enhancements, improvements and other changes to its semiconductor products and services per JESD46C and to discontinue any product or service per JESD48B. Buyers should obtain the latest relevant information before placing orders and should verify that such information is current and complete. All semiconductor products (also referred to herein as "components") are sold subject to TI's terms and conditions of sale supplied at the time of order acknowledgment.

TI warrants performance of its components to the specifications applicable at the time of sale, in accordance with the warranty in TI's terms and conditions of sale of semiconductor products. Testing and other quality control techniques are used to the extent TI deems necessary to support this warranty. Except where mandated by applicable law, testing of all parameters of each component is not necessarily performed.

TI assumes no liability for applications assistance or the design of Buyers' products. Buyers are responsible for their products and applications using TI components. To minimize the risks associated with Buyers' products and applications, Buyers should provide adequate design and operating safeguards.

TI does not warrant or represent that any license, either express or implied, is granted under any patent right, copyright, mask work right, or other intellectual property right relating to any combination, machine, or process in which TI components or services are used. Information published by TI regarding third-party products or services does not constitute a license to use such products or services or a warranty or endorsement thereof. Use of such information may require a license from a third party under the patents or other intellectual property of the third party, or a license from TI under the patents or other intellectual property of TI.

Reproduction of significant portions of TI information in TI data books or data sheets is permissible only if reproduction is without alteration and is accompanied by all associated warranties, conditions, limitations, and notices. TI is not responsible or liable for such altered documentation. Information of third parties may be subject to additional restrictions.

Resale of TI components or services with statements different from or beyond the parameters stated by TI for that component or service voids all express and any implied warranties for the associated TI component or service and is an unfair and deceptive business practice. TI is not responsible or liable for any such statements.

Buyer acknowledges and agrees that it is solely responsible for compliance with all legal, regulatory and safety-related requirements concerning its products, and any use of TI components in its applications, notwithstanding any applications-related information or support that may be provided by TI. Buyer represents and agrees that it has all the necessary expertise to create and implement safeguards which anticipate dangerous consequences of failures, monitor failures and their consequences, lessen the likelihood of failures that might cause harm and take appropriate remedial actions. Buyer will fully indemnify TI and its representatives against any damages arising out of the use of any TI components in safety-critical applications.

In some cases, TI components may be promoted specifically to facilitate safety-related applications. With such components, TI's goal is to help enable customers to design and create their own end-product solutions that meet applicable functional safety standards and requirements. Nonetheless, such components are subject to these terms.

No TI components are authorized for use in FDA Class III (or similar life-critical medical equipment) unless authorized officers of the parties have executed a special agreement specifically governing such use.

Only those TI components which TI has specifically designated as military grade or "enhanced plastic" are designed and intended for use in military/aerospace applications or environments. Buyer acknowledges and agrees that any military or aerospace use of TI components which have **not** been so designated is solely at the Buyer's risk, and that Buyer is solely responsible for compliance with all legal and regulatory requirements in connection with such use.

TI has specifically designated certain components which meet ISO/TS16949 requirements, mainly for automotive use. Components which have not been so designated are neither designed nor intended for automotive use; and TI will not be responsible for any failure of such components to meet such requirements.

Products

| | |
|------------------------|--|
| Audio | www.ti.com/audio |
| Amplifiers | amplifier.ti.com |
| Data Converters | dataconverter.ti.com |
| DLP® Products | www.dlp.com |
| DSP | dsp.ti.com |
| Clocks and Timers | www.ti.com/clocks |
| Interface | interface.ti.com |
| Logic | logic.ti.com |
| Power Mgmt | power.ti.com |
| Microcontrollers | microcontroller.ti.com |
| RFID | www.ti-rfid.com |
| OMAP Mobile Processors | www.ti.com/omap |
| Wireless Connectivity | www.ti.com/wirelessconnectivity |

Applications

| | |
|-------------------------------|--|
| Automotive and Transportation | www.ti.com/automotive |
| Communications and Telecom | www.ti.com/communications |
| Computers and Peripherals | www.ti.com/computers |
| Consumer Electronics | www.ti.com/consumer-apps |
| Energy and Lighting | www.ti.com/energy |
| Industrial | www.ti.com/industrial |
| Medical | www.ti.com/medical |
| Security | www.ti.com/security |
| Space, Avionics and Defense | www.ti.com/space-avionics-defense |
| Video and Imaging | www.ti.com/video |

TI E2E Community e2e.ti.com