

OPAx180 0.1- $\mu\text{V}/^\circ\text{C}$ Drift, Low-Noise, Rail-to-Rail Output, 36-V, Zero-Drift Operational Amplifiers

1 Features

- Low Offset Voltage: 75 μV (max)
- Zero-Drift: 0.1 $\mu\text{V}/^\circ\text{C}$
- Low Noise: 10 $\text{nV}/\sqrt{\text{Hz}}$
- Very Low 1 / f Noise
- Excellent DC Precision:
 - PSRR: 126 dB
 - CMRR: 114 dB
 - Open-Loop Gain (A_{OL}): 120 dB
- Quiescent Current: 525 μA (max)
- Wide Supply Range: $\pm 2\text{ V}$ to $\pm 18\text{ V}$
- Rail-to-Rail Output:
Input Includes Negative Rail
- Low Bias Current: 250 pA (typ)
- RFI Filtered Inputs
- *MicroSIZE* Packages

2 Applications

- Bridge Amplifiers
- Strain Gauges
- Test Equipment
- Transducer Applications
- Temperature Measurement
- Electronic Scales
- Medical Instrumentation
- Resistor Thermal Detectors
- Precision Active Filters

3 Description

The OPA180, OPA2180, and OPA4180 operational amplifiers use zero-drift techniques to simultaneously provide low offset voltage (75 μV), and near zero-drift over time and temperature. These miniature, high-precision, low quiescent current amplifiers offer high input impedance and rail-to-rail output swing within 18 mV of the rails. The input common-mode range includes the negative rail. Either single or dual supplies can be used in the range of 4.0 V to 36 V ($\pm 2\text{ V}$ to $\pm 18\text{ V}$).

The dual version is offered in VSSOP-8 and SOIC-8 packages. The quad is offered in SOIC-14 and TSSOP-14 packages. All versions are specified for operation from -40°C to 105°C .

Device Information⁽¹⁾

DEVICE NAME	PACKAGE	BODY SIZE (NOM)
OPA180	SOT23 (5)	1.60 mm \times 2.90 mm
	VSSOP, MSOP (8)	3.00 mm \times 3.00 mm
	SOIC (8)	4.90 mm \times 3.91 mm
OPA2180	VSSOP, MSOP (8)	3.00 mm \times 3.00 mm
	SOIC (8)	4.90 mm \times 3.91 mm
OPA4180	TSSOP (14)	5.00 mm \times 4.40 mm
	SOIC (14)	8.65 mm \times 3.91 mm

(1) For all available packages, see the orderable addendum at the end of the datasheet.

Low Noise (Peak-to-Peak Noise = 250 nV)

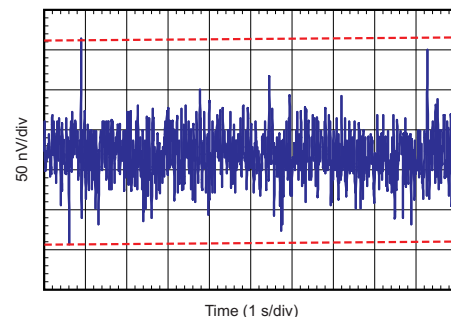

Table of Contents

1 Features	1	8.1 Overview	13
2 Applications	1	8.2 Functional Block Diagram	13
3 Description	1	8.3 Feature Description	13
4 Revision History	2	8.4 Device Functional Modes	16
5 Zero-Drift Amplifier Portfolio	3	9 Application and Implementation	17
6 Pin Configuration and Functions	3	9.1 Application Information	17
7 Specifications	4	9.2 Typical Applications	17
7.1 Absolute Maximum Ratings	4	10 Power Supply Recommendations	21
7.2 Handling Ratings	4	11 Layout	22
7.3 Recommended Operating Conditions	5	11.1 Layout Guidelines	22
7.4 Thermal Information: OPA180	5	11.2 Layout Example	22
7.5 Thermal Information: OPA2180	5	12 Device and Documentation Support	23
7.6 Thermal Information: OPA4180	5	12.1 Related Links	23
7.7 Electrical Characteristics: $V_S = \pm 2\text{ V to } \pm 18\text{ V}$ ($V_S = 4\text{ V to } 36\text{ V}$)	6	12.2 Trademarks	23
7.8 Typical Characteristics	8	12.3 Electrostatic Discharge Caution	23
7.9 Typical Characteristics	9	12.4 Glossary	23
8 Detailed Description	13	13 Mechanical, Packaging, and Orderable Information	23

4 Revision History

NOTE: Page numbers for previous revisions may differ from page numbers in the current version.

Changes from Revision C (December 2012) to Revision D	Page
• Changed format to meet latest data sheet standards; added <i>Device Functional Modes</i> , <i>Application and Implementation</i> , and <i>Power Supply Recommendations</i> sections, and moved existing sections	1
• Added OPA180 to document	1
• Added Device Information table	1
• Deleted Package Information table	3
• OPA180 pin out drawings	3
• Added Pin Functions table	4
• Added Recommended Operating Conditions table	5
• Added Thermal Information: OPA180 table	5
• Changed Offset Voltage, <i>Long-term stability</i> parameter typical specification in Electrical Characteristics table	6
• Changed last sentence of <i>EMI Rejection</i> section	14

Changes from Revision B (December 2011) to Revision C	Page
• Changed product status from Mixed Status to Production Data	1
• Changed OPA4180 status to Production Data	1
• Added package marking to OPS2180 VSSOP-8 row in Package Information table	3
• Deleted ordering number and transport media columns from Package Information table	3
• Changed Input Bias Current section in Electrical Characteristics ($V_S = +4\text{ V to } +36\text{ V}$) table	6

Changes from Revision A (November 2011) to Revision B	Page
• Changed footnote 1 of Electrical Characteristics table	6
• Updated Figure 7	9

5 Zero-Drift Amplifier Portfolio

VERSION	PRODUCT	OFFSET VOLTAGE (μV)	OFFSET VOLTAGE DRIFT (μV/°C)	BANDWIDTH (MHz)
Single	OPA188 (4 V to 36 V)	25	0.085	2
	OPA180 (4 V to 36 V)	75	0.35	2
	OPA333 (5 V)	10	0.05	0.35
	OPA378 (5 V)	50	0.25	0.9
	OPA735 (12 V)	5	0.05	1.6
Dual	OPA2188 (4 V to 36 V)	25	0.085	2
	OPA2180 (4 V to 36 V)	75	0.35	2
	OPA2333 (5 V)	10	0.05	0.35
	OPA2378 (5 V)	50	0.25	0.9
	OPA2735 (12 V)	5	0.05	1.6
Quad	OPA4188 (4 V to 36 V)	25	0.085	2
	OPA4180 (4 V to 36 V)	75	0.35	2
	OPA4330 (5 V)	50	0.25	0.35

6 Pin Configuration and Functions

OPA180
DBV Package (SOT23-5)
(Top View)

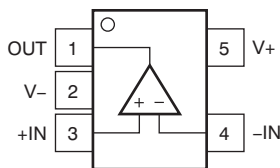

OPA180
D and DGK Packages (SO-8 and MSOP-8)
(Top View)

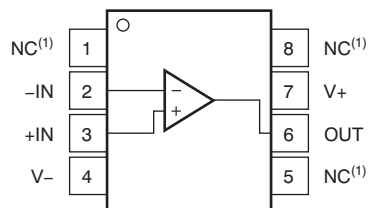

OPA2180
D, DGK Packages (SOIC-8, VSSOP-8)
(Top View)

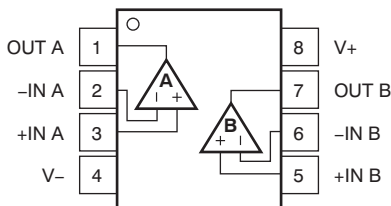

OPA4180
D, PW Packages (SOIC-14, TSSOP-14)
(Top View)

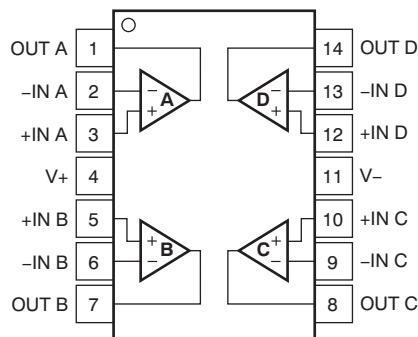

Pin Functions

NAME	PIN				DESCRIPTION
	OPA180		OPA2180	OPA4180	
	DBV	D (8), DGK	D (8), DGK	D (14), PW	
–IN A	4	2	2	2	Inverting input
+IN A	3	3	3	3	Noninverting input
–IN B	—	—	6	6	Inverting input
+IN B	—	—	5	5	Noninverting input
–IN C	—	—	—	9	Inverting input
+IN C	—	—	—	10	Noninverting input
–IN D	—	—	—	13	Inverting input
+IN D	—	—	—	12	Noninverting input
OUT A	1	6	1	1	Output
OUT B	—	—	7	7	Output
OUT C	—	—	—	8	Output
OUT D	—	—	—	14	Output
V–	2	4	4	11	Negative supply or ground (for single-supply operation)
V+	5	7	8	4	Positive supply or ground (for single-supply operation)

7 Specifications

7.1 Absolute Maximum Ratings

over operating free-air temperature range (unless otherwise noted)⁽¹⁾

		MIN	MAX	UNIT
Supply voltage		±20, 40 (single supply)		V
Signal input terminals	Voltage	(V–) – 0.5	(V+) + 0.5	V
	Current	±10		mA
Output short-circuit ⁽²⁾		Continuous		
Operating temperature		–55	105	°C
Storage temperature		–65	150	°C
Junction temperature		150		°C

- (1) Stresses beyond those listed under *Absolute Maximum Ratings* may cause permanent damage to the device. These are stress ratings only, which do not imply functional operation of the device at these or any other conditions beyond those indicated under *Recommended Operating Conditions*. Exposure to absolute-maximum-rated conditions for extended periods may affect device reliability.
- (2) Short-circuit to ground, one amplifier per package.

7.2 Handling Ratings

			MIN	MAX	UNIT
T _{stg}	Storage temperature range		–65	150	°C
V _(ESD)	Electrostatic discharge	Human body model (HBM), per ANSI/ESDA/JEDEC JS-001, all pins ⁽¹⁾	–1.5	1.5	kV
		Charged device model (CDM), per JEDEC specification JESD22-C101, all pins ⁽²⁾	–1	1	

- (1) JEDEC document JEP155 states that 500-V HBM allows safe manufacturing with a standard ESD control process.
- (2) JEDEC document JEP157 states that 250-V CDM allows safe manufacturing with a standard ESD control process.

7.3 Recommended Operating Conditions

over operating free-air temperature range (unless otherwise noted)

		MIN	NOM	MAX	UNIT
Supply voltage [(V+) – (V–)]	Single supply	4.5		36	V
	Bipolar supply	±2.25		±18	V
Operating temperature		–40		105	°C

7.4 Thermal Information: OPA180

THERMAL METRIC ⁽¹⁾		OPA180			UNIT
		D (SO)	DBV (SOT23)	DGK (MSOP)	
		8 PINS	5 PINS	8 PINS	
R _{θJA}	Junction-to-ambient thermal resistance	115.8	158.8	180.4	°C/W
R _{θJC(top)}	Junction-to-case(top) thermal resistance	60.1	60.7	67.9	
R _{θJB}	Junction-to-board thermal resistance	56.4	44.8	102.1	
Ψ _{JT}	Junction-to-top characterization parameter	12.8	1.6	10.4	
Ψ _{JB}	Junction-to-board characterization parameter	55.9	4.2	100.3	
R _{θJC(bot)}	Junction-to-case(bottom) thermal resistance	N/A	N/A	N/A	

(1) For more information about traditional and new thermal metrics, see the *IC Package Thermal Metrics* application report, [SPRA953](#).

7.5 Thermal Information: OPA2180

THERMAL METRIC ⁽¹⁾		OPA2180		UNIT
		D (SO)	DGK (MSOP)	
		8 PINS	8 PINS	
R _{θJA}	Junction-to-ambient thermal resistance	111.0	159.3	°C/W
R _{θJC(top)}	Junction-to-case (top) thermal resistance	54.9	37.4	
R _{θJB}	Junction-to-board thermal resistance	51.7	48.5	
Ψ _{JT}	Junction-to-top characterization parameter	9.3	1.2	
Ψ _{JB}	Junction-to-board characterization parameter	51.1	77.1	
R _{θJC(bot)}	Junction-to-case (bottom) thermal resistance	n/a	n/a	

(1) For more information about traditional and new thermal metrics, see the *IC Package Thermal Metrics* application report, [SPRA953](#).

7.6 Thermal Information: OPA4180

THERMAL METRIC ⁽¹⁾		OPA4180		UNIT
		D (SO)	PW (TSSOP)	
		14 PINS	14 PINS	
R _{θJA}	Junction-to-ambient thermal resistance	93.2	106.9	°C/W
R _{θJC(top)}	Junction-to-case (top) thermal resistance	51.8	24.4	
R _{θJB}	Junction-to-board thermal resistance	49.4	59.3	
Ψ _{JT}	Junction-to-top characterization parameter	13.5	0.6	
Ψ _{JB}	Junction-to-board characterization parameter	42.2	54.3	
R _{θJC(bot)}	Junction-to-case (bottom) thermal resistance	n/a	n/a	

(1) For more information about traditional and new thermal metrics, see the *IC Package Thermal Metrics* application report, [SPRA953](#).

7.7 Electrical Characteristics: $V_S = \pm 2\text{ V}$ to $\pm 18\text{ V}$ ($V_S = 4\text{ V}$ to 36 V)

 At $T_A = 25^\circ\text{C}$, $R_L = 10\text{ k}\Omega$ connected to $V_S / 2$, and $V_{\text{COM}} = V_{\text{OUT}} = V_S / 2$, unless otherwise noted.

PARAMETER		CONDITIONS	MIN	TYP	MAX	UNIT
OFFSET VOLTAGE						
V_{IO}	Input offset voltage			15	75	μV
dV_{IO}/dT	Input offset voltage drift	$T_A = -40^\circ\text{C}$ to 105°C		0.1	0.35	$\mu\text{V}/^\circ\text{C}$
PSRR	Power-supply rejection ratio	$V_S = 4\text{ V}$ to 36 V , $V_{\text{CM}} = V_S / 2$		0.1	0.5	$\mu\text{V}/\text{V}$
		$T_A = -40^\circ\text{C}$ to 105°C , $V_S = 4\text{ V}$ to 36 V , $V_{\text{CM}} = V_S / 2$			0.5	$\mu\text{V}/\text{V}$
	Long-term stability			4 ⁽¹⁾		μV
	Channel separation, dc			1		$\mu\text{V}/\text{V}$
INPUT BIAS CURRENT						
I_{IB}	Input bias current	OPA2180		± 0.25	± 1	nA
		OPA2180, $T_A = -40^\circ\text{C}$ to 105°C			± 5	nA
		OPA4180, OPA180		± 0.25	± 1.7	nA
		OPA4180, OPA180, $T_A = -40^\circ\text{C}$ to 105°C			± 6	nA
I_{IO}	Input offset current	OPA2180		± 0.5	± 2	nA
		OPA2180, $T_A = -40^\circ\text{C}$ to 105°C			± 2.5	nA
		OPA4180, OPA180			± 3.4	nA
		OPA4180, OPA180, $T_A = -40^\circ\text{C}$ to 105°C			± 3	nA
NOISE						
	Input voltage noise	$f = 0.1\text{ Hz}$ to 10 Hz		0.25		μV_{PP}
e_n	Input voltage noise density	$f = 1\text{ kHz}$		10		$\text{nV}/\sqrt{\text{Hz}}$
i_n	Input current noise density	$f = 1\text{ kHz}$		10		$\text{fA}/\sqrt{\text{Hz}}$
INPUT VOLTAGE RANGE						
V_{CM}	Common-mode voltage range		V^-		$(V^+) - 1.5$	V
CMRR	Common-mode rejection ratio	$(V^-) < V_{\text{CM}} < (V^+) - 1.5\text{ V}$	104	114		dB
		$T_A = -40^\circ\text{C}$ to 105°C , $(V^-) + 0.5\text{ V} < V_{\text{CM}} < (V^+) - 1.5\text{ V}$	100	104		dB
INPUT IMPEDANCE						
Z_{id}	Differential			100 6		$\text{M}\Omega$ pF
Z_{ic}	Common-mode			6 9.5		$10^{12}\ \Omega$ pF
OPEN-LOOP GAIN						
A_{OL}	Open-loop voltage gain	$(V^-) + 500\text{ mV} < V_{\text{O}} < (V^+) - 500\text{ mV}$, $R_L = 10\text{ k}\Omega$	110	120		dB
		$T_A = -40^\circ\text{C}$ to 105°C , $(V^-) + 500\text{ mV} < V_{\text{O}} < (V^+) - 500\text{ mV}$, $R_L = 10\text{ k}\Omega$	104	114		dB
FREQUENCY RESPONSE						
GBW	Gain bandwidth product			2		MHz
SR	Slew rate	$G = 1$		0.8		$\text{V}/\mu\text{s}$
t_s	Settling time	0.1%	$V_S = \pm 18\text{ V}$, $G = 1$, 10-V step	22		μs
		0.01%	$V_S = \pm 18\text{ V}$, $G = 1$, 10-V step	30		μs
t_{or}	Overload recovery time	$V_{\text{IN}} \times G = V_S$		1		μs
THD+N	Total harmonic distortion + noise	$f = 1\text{ kHz}$, $G = 1$, $V_{\text{OUT}} = 1\text{ V}_{\text{RMS}}$		0.0001%		

 (1) 1000-hour life test at 125°C demonstrated randomly distributed variation in the range of measurement limits, or approximately $4\ \mu\text{V}$.

Electrical Characteristics: $V_S = \pm 2\text{ V}$ to $\pm 18\text{ V}$ ($V_S = 4\text{ V}$ to 36 V) (continued)

 At $T_A = 25^\circ\text{C}$, $R_L = 10\text{ k}\Omega$ connected to $V_S / 2$, and $V_{\text{COM}} = V_{\text{OUT}} = V_S / 2$, unless otherwise noted.

PARAMETER	CONDITIONS	MIN	TYP	MAX	UNIT
OUTPUT					
Voltage output swing from rail	No load		8	18	mV
	$R_L = 10\text{ k}\Omega$		250	300	mV
	$T_A = -40^\circ\text{C}$ to 105°C , $R_L = 10\text{ k}\Omega$		325	360	mV
I_{OS}	Short-circuit current		± 18		mA
r_o	Output resistance (open loop)	$f = 2\text{ MHz}$, $I_O = 0\text{ mA}$	120		Ω
C_{LOAD}	Capacitive load drive		1		nF
POWER SUPPLY					
V_S	Operating voltage range	± 2 (or 4)		± 18 (or 36)	V
I_Q	Quiescent current (per amplifier)		450	525	μA
		$T_A = -40^\circ\text{C}$ to 105°C , $I_O = 0\text{ mA}$		600	μA
TEMPERATURE					
	Specified range		-40	105	$^\circ\text{C}$
	Operating range		-40	105	$^\circ\text{C}$

7.8 Typical Characteristics

Table 1. Characteristic Performance Measurements

DESCRIPTION	FIGURE
I_B and I_{OS} vs Common-Mode Voltage	Figure 1
Input Bias Current vs Temperature	Figure 2
Output Voltage Swing vs Output Current (Maximum Supply)	Figure 3
CMRR vs Temperature	Figure 4
0.1-Hz to 10-Hz Noise	Figure 5
Input Voltage Noise Spectral Density vs Frequency	Figure 6
Open-Loop Gain and Phase vs Frequency	Figure 7
Open-Loop Gain vs Temperature	Figure 8
Open-Loop Output Impedance vs Frequency	Figure 9
Small-Signal Overshoot vs Capacitive Load (100-mV Output Step)	Figure 10 , Figure 11
No Phase Reversal	Figure 12
Positive Overload Recovery	Figure 13
Negative Overload Recovery	Figure 14
Small-Signal Step Response (100 mV)	Figure 15 , Figure 16
Large-Signal Step Response	Figure 17 , Figure 18
Large-Signal Settling Time (10-V Positive Step)	Figure 19
Large-Signal Settling Time (10-V Negative Step)	Figure 20
Short-Circuit Current vs Temperature	Figure 21
Maximum Output Voltage vs Frequency	Figure 22
Channel Separation vs Frequency	Figure 23
EMIRR IN+ vs Frequency	Figure 24

7.9 Typical Characteristics

$V_S = \pm 18\text{ V}$, $V_{CM} = V_S / 2$, $R_{LOAD} = 10\text{ k}\Omega$ connected to $V_S / 2$, and $C_L = 100\text{ pF}$, unless otherwise noted.

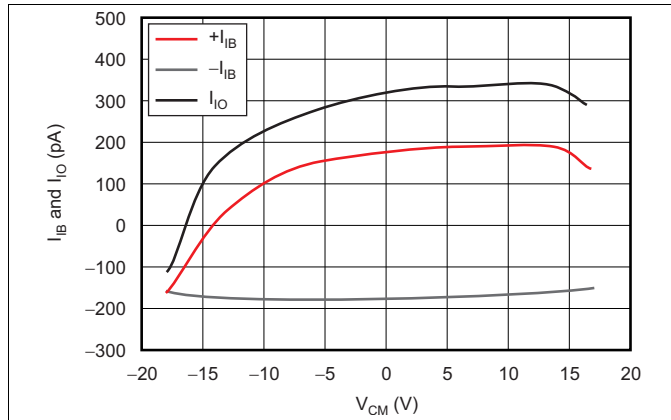

Figure 1. I_{IB} and I_{IO} vs Common-Mode Voltage

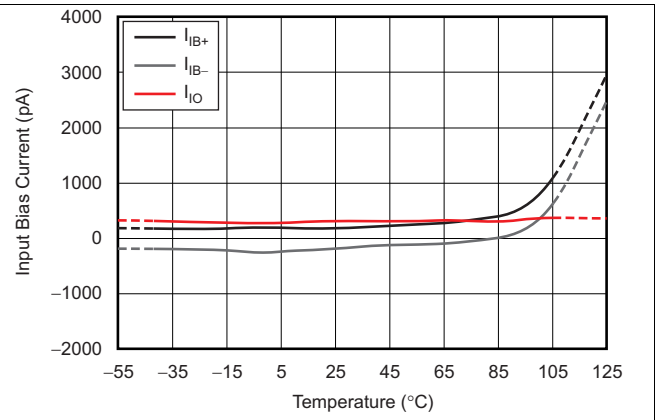

Figure 2. Input Bias Current vs Temperature

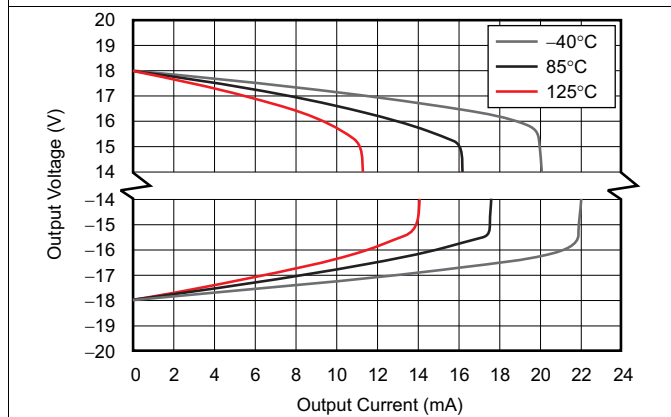
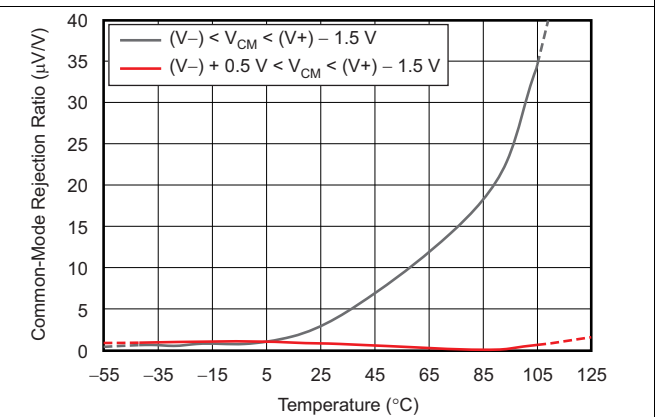

Figure 3. Output Voltage Swing vs Output Current (Maximum Supply)



$V_{SUPPLY} = \pm 2\text{ V}$

Figure 4. CMRR vs Temperature

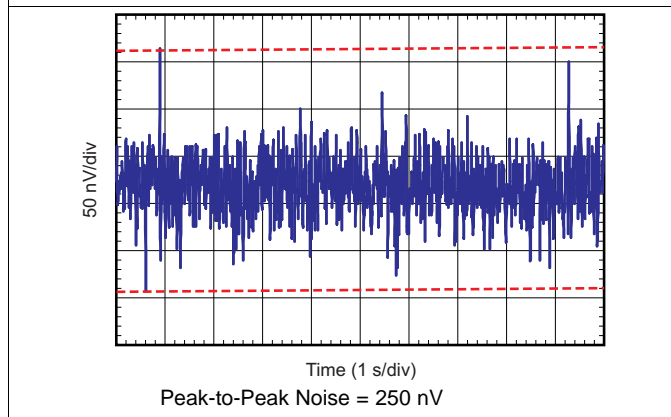

Figure 5. 0.1-Hz to 10-Hz Noise

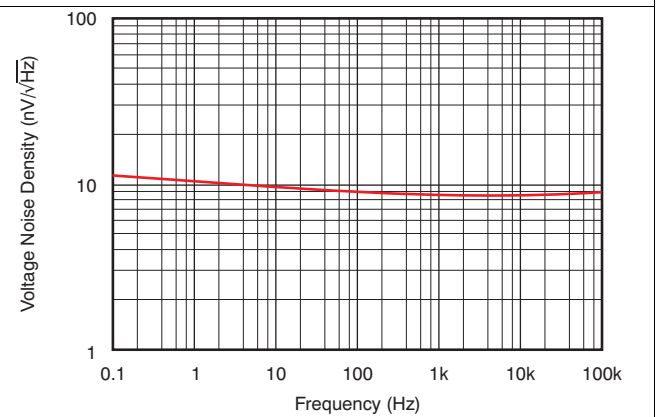

Figure 6. Input Voltage Noise Spectral Density vs Frequency

Typical Characteristics (continued)

$V_S = \pm 18\text{ V}$, $V_{CM} = V_S / 2$, $R_{LOAD} = 10\text{ k}\Omega$ connected to $V_S / 2$, and $C_L = 100\text{ pF}$, unless otherwise noted.

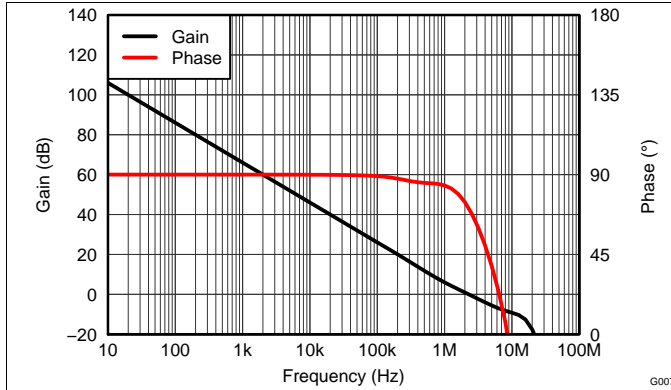

Figure 7. Open-Loop Gain and Phase vs Frequency

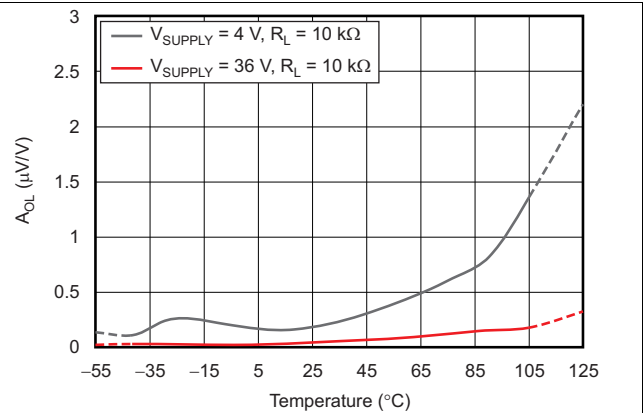

Figure 8. Open-Loop Gain vs Temperature

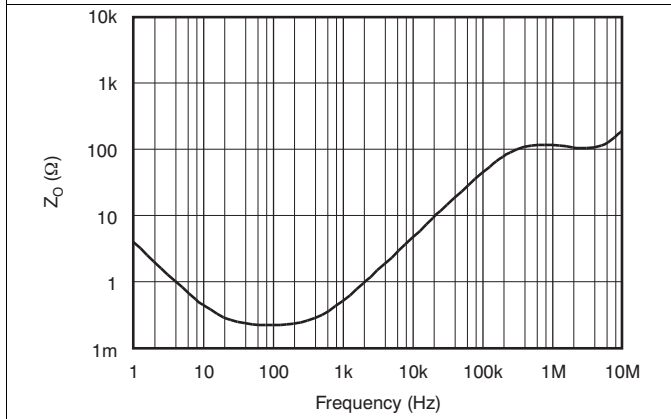

Figure 9. Open-Loop Output Impedance vs Frequency

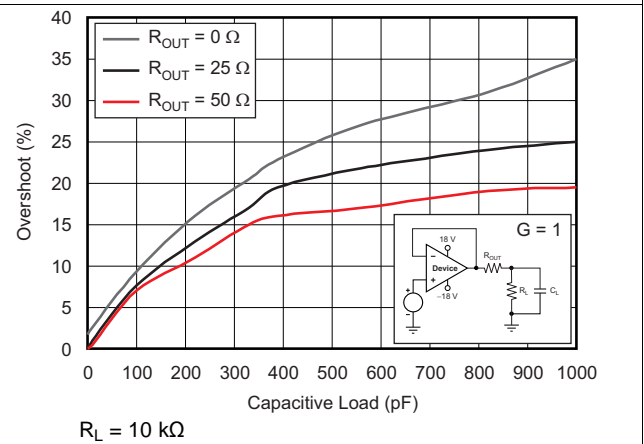

Figure 10. Small-Signal Overshoot vs Capacitive Load (100-mV Output Step)

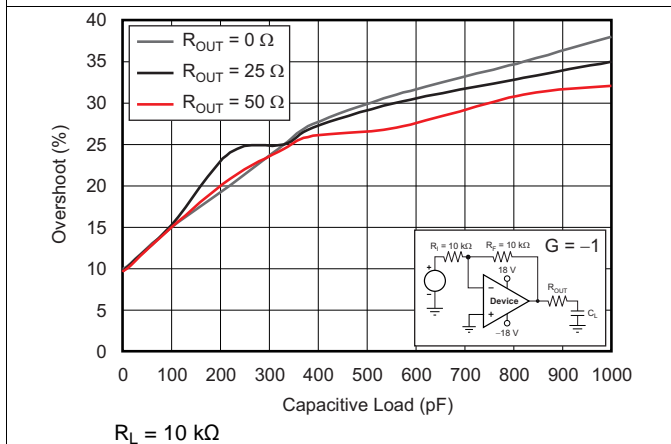

Figure 11. Small-Signal Overshoot vs Capacitive Load (100-mV Output Step)

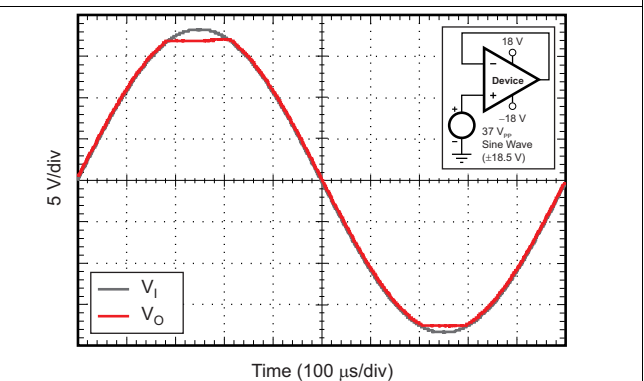

Figure 12. No Phase Reversal

Typical Characteristics (continued)

$V_S = \pm 18\text{ V}$, $V_{CM} = V_S / 2$, $R_{LOAD} = 10\text{ k}\Omega$ connected to $V_S / 2$, and $C_L = 100\text{ pF}$, unless otherwise noted.

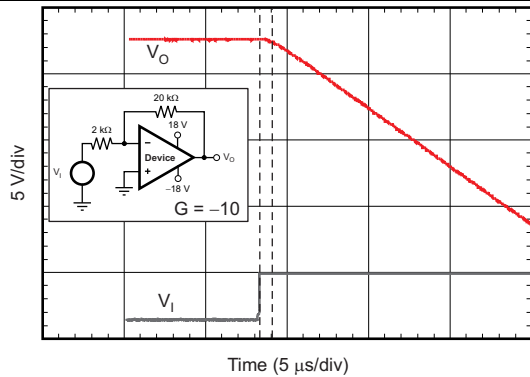

Figure 13. Positive Overload Recovery

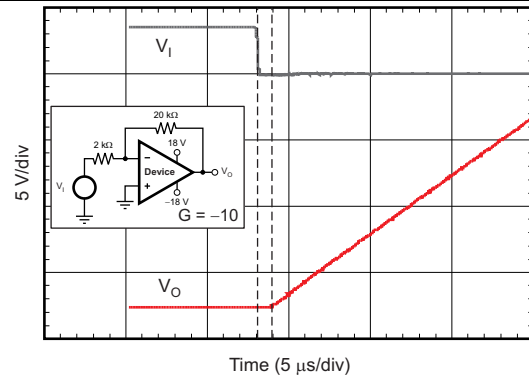

Figure 14. Negative Overload Recovery

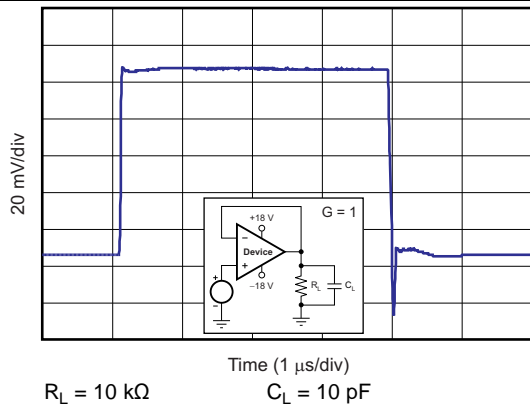

Figure 15. Small-Signal Step Response (100 mV)

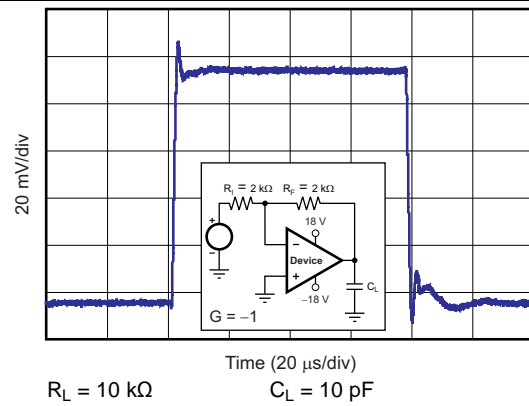

Figure 16. Small-Signal Step Response (100 mV)

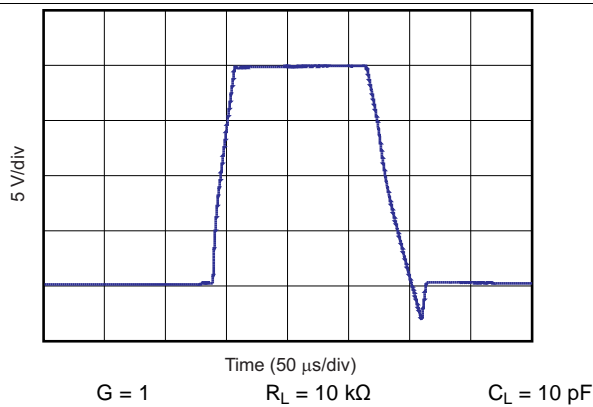

Figure 17. Large-Signal Step Response

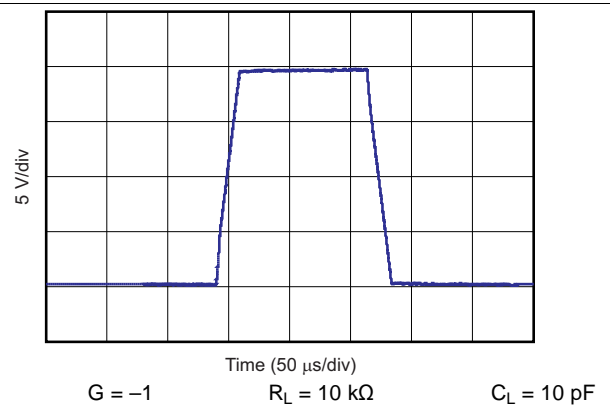

Figure 18. Large-Signal Step Response

Typical Characteristics (continued)

$V_S = \pm 18\text{ V}$, $V_{CM} = V_S / 2$, $R_{LOAD} = 10\text{ k}\Omega$ connected to $V_S / 2$, and $C_L = 100\text{ pF}$, unless otherwise noted.

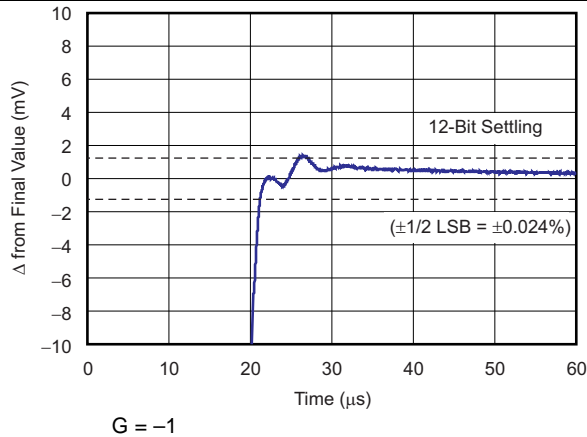

Figure 19. Large-Signal Settling Time (10-V Positive Step)

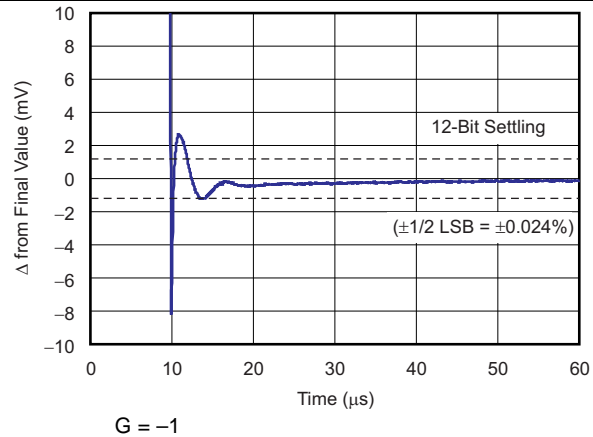

Figure 20. Large-Signal Settling Time (10-V Negative Step)

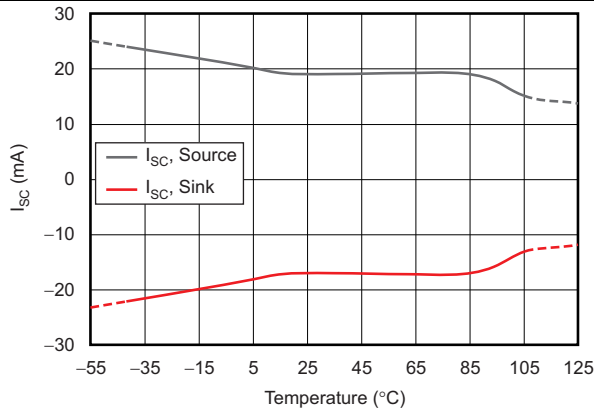

Figure 21. Short-Circuit Current vs Temperature

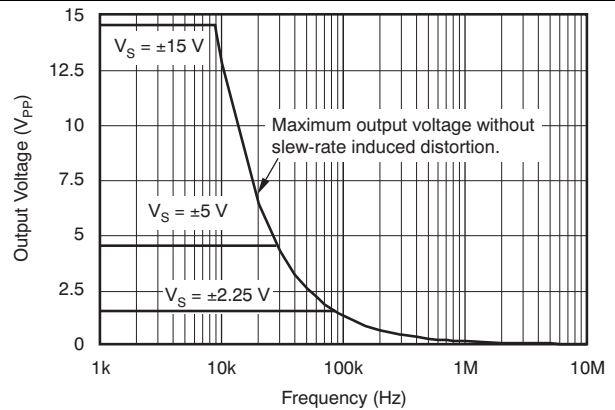

Figure 22. Maximum Output Voltage vs Frequency

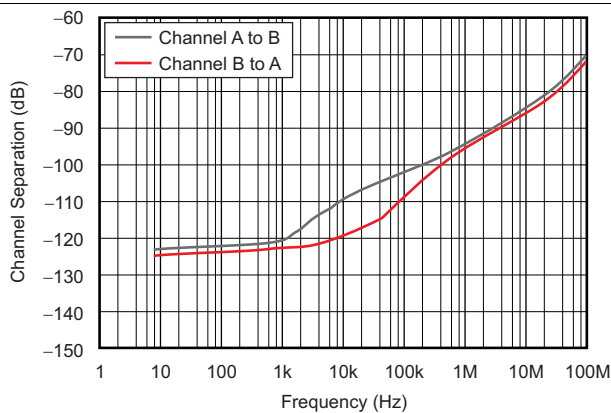

Figure 23. Channel Separation vs Frequency

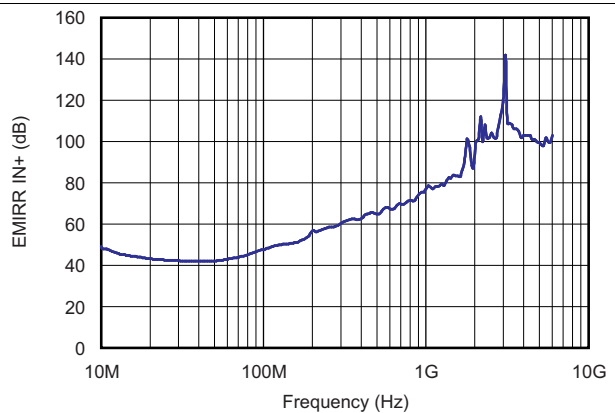

Figure 24. EMIRR IN+ vs Frequency

8 Detailed Description

8.1 Overview

The OPAx180 family of operational amplifiers combine precision offset and drift with excellent overall performance, making them ideal for many precision applications. The precision offset drift of only 0.1 $\mu\text{V}/^\circ\text{C}$ provides stability over the entire temperature range. In addition, the devices offer excellent overall performance with high CMRR, PSRR, and A_{OL} . As with all amplifiers, applications with noisy or high-impedance power supplies require decoupling capacitors close to the device pins. In most cases, 0.1- μF capacitors are adequate.

8.2 Functional Block Diagram

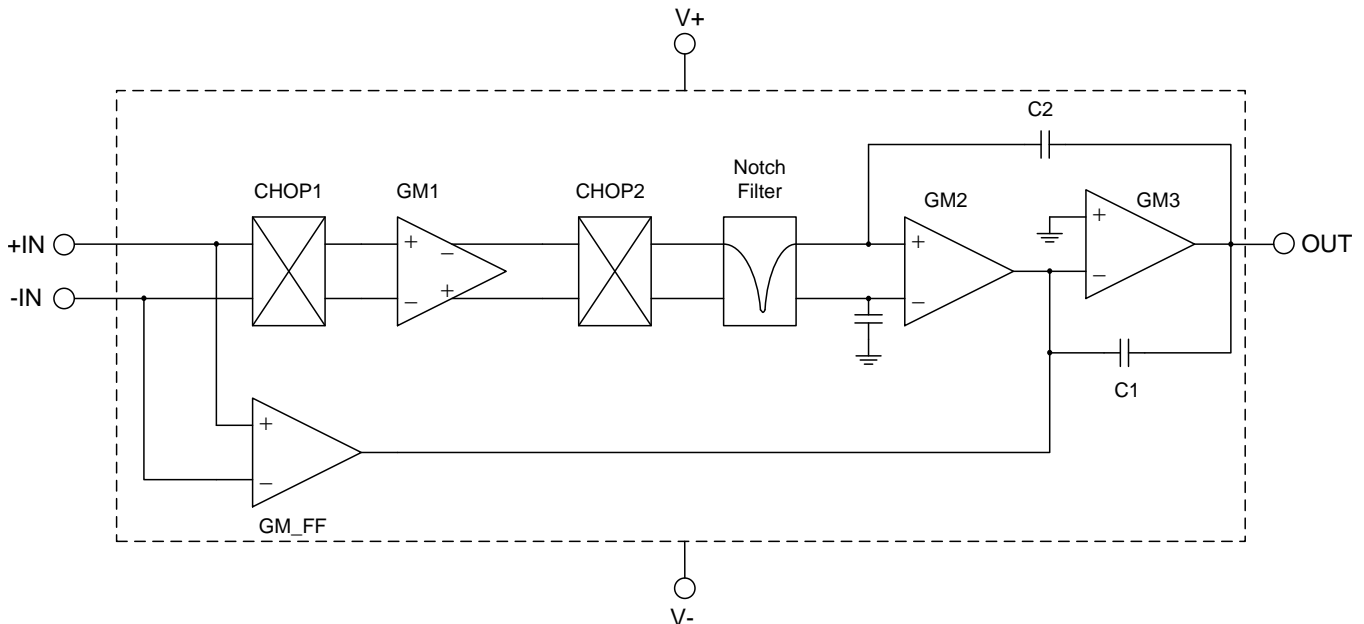

8.3 Feature Description

8.3.1 Operating Characteristics

The OPAx180 family of amplifiers is specified for operation from 4 V to 36 V (± 2 V to ± 18 V). Many of the specifications apply from -40°C to 105°C . Parameters that can exhibit significant variance with regard to operating voltage or temperature are presented in the [Typical Characteristics](#).

Feature Description (continued)

8.3.2 EMI Rejection

The OPAX180 uses integrated electromagnetic interference (EMI) filtering to reduce the effects of EMI interference from sources such as wireless communications and densely populated boards with a mix of analog signal chain and digital components. EMI immunity can be improved with circuit design techniques; the OPAX180 benefits from these design improvements. Texas Instruments has developed the ability to accurately measure and quantify the immunity of an operational amplifier over a broad frequency spectrum extending from 10 MHz to 6 GHz. [Figure 25](#) shows the results of this testing on the OPAX180. Detailed information can also be found in the application report, *EMI Rejection Ratio of Operational Amplifiers (SBOA128)*, available for download from www.ti.com.

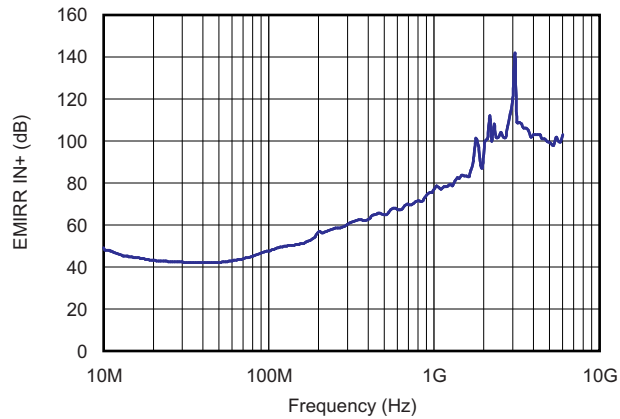

Figure 25. OPAX180 EMIRR Testing

8.3.3 Phase-Reversal Protection

The OPAX180 family has an internal phase-reversal protection. Many op amps exhibit a phase reversal when the input is driven beyond its linear common-mode range. This condition is most often encountered in noninverting circuits when the input is driven beyond the specified common-mode voltage range, causing the output to reverse into the opposite rail. The input of the OPAX180 prevents phase reversal with excessive common-mode voltage. Instead, the output limits into the appropriate rail. This performance is shown in [Figure 26](#).

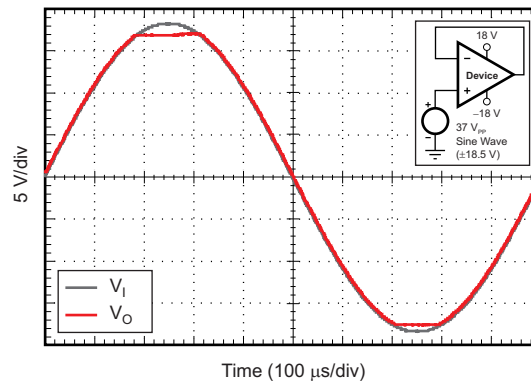
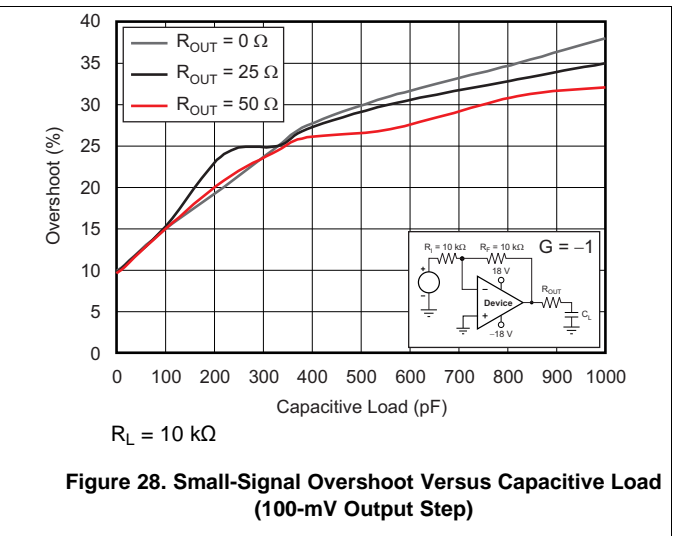
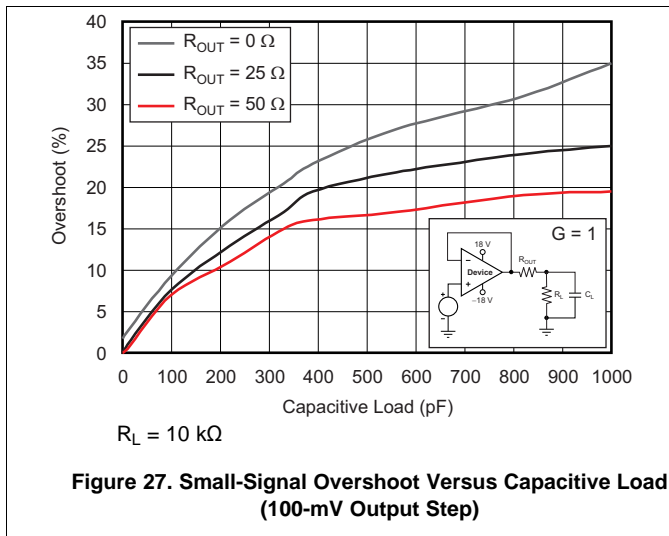

Figure 26. No Phase Reversal

Feature Description (continued)

8.3.4 Capacitive Load and Stability

The dynamic characteristics of the OPAx180 have been optimized for a range of common operating conditions. The combination of low closed-loop gain and high capacitive loads decreases the phase margin of the amplifier and can lead to gain peaking or oscillations. As a result, heavier capacitive loads must be isolated from the output. The simplest way to achieve this isolation is to add a small resistor (for example, R_{OUT} equal to 50 Ω) in series with the output. Figure 27 and Figure 28 illustrate graphs of small-signal overshoot versus capacitive load for several values of R_{OUT} . Also, refer to the [Applications Report, Feedback Plots Define Op Amp AC Performance \(SBOA015\)](#), available for download from the TI website, for details of analysis techniques and application circuits.



8.3.5 Electrical Overstress

Designers often ask questions about the capability of an operational amplifier to withstand electrical overstress. These questions tend to focus on the device inputs, but may involve the supply voltage pins or even the output pin. Each of these different pin functions have electrical stress limits determined by the voltage breakdown characteristics of the particular semiconductor fabrication process and specific circuits connected to the pin. Additionally, internal electrostatic discharge (ESD) protection is built into these circuits to protect them from accidental ESD events both before and during product assembly.

These ESD protection diodes also provide in-circuit, input overdrive protection, as long as the current is limited to 10 mA as stated in the [Absolute Maximum Ratings](#). Figure 29 shows how a series input resistor may be added to the driven input to limit the input current. The added resistor contributes thermal noise at the amplifier input and its value should be kept to a minimum in noise-sensitive applications.

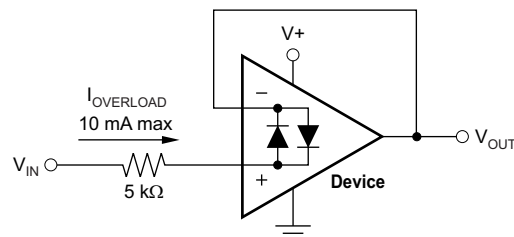

Figure 29. Input Current Protection

An ESD event produces a short duration, high-voltage pulse that is transformed into a short duration, high-current pulse as it discharges through a semiconductor device. The ESD protection circuits are designed to provide a current path around the operational amplifier core to prevent it from being damaged. The energy absorbed by the protection circuitry is then dissipated as heat.

Feature Description (continued)

When the operational amplifier connects into a circuit, the ESD protection components are intended to remain inactive and not become involved in the application circuit operation. However, circumstances may arise where an applied voltage exceeds the operating voltage range of a given pin. Should this condition occur, there is a risk that some of the internal ESD protection circuits may be biased on, and conduct current. Any such current flow occurs through ESD cells and rarely involves the absorption device.

If there is an uncertainty about the ability of the supply to absorb this current, external zener diodes may be added to the supply pins. The zener voltage must be selected such that the diode does not turn on during normal operation.

However, its zener voltage should be low enough so that the zener diode conducts if the supply pin begins to rise above the safe operating supply voltage level.

8.4 Device Functional Modes

The OPA180, OPA2180, and OPA4180 are powered on when the supply is connected. These devices can be operated as a single-supply operational amplifier or dual-supply amplifier depending on the application. In single-supply operation with V_- at ground (0 V), V_+ can be any value between 4 V and 36 V. In dual-supply operation the supply voltage difference between V_- and V_+ is from 4 V to 36 V. Typical examples of dual-supply configuration are ± 5 V, ± 10 V, ± 15 V, and ± 18 V. However the supplies must not be symmetrical. Less common examples are V_- at -3 V and V_+ at 9 V or V_- at -16 V and V_+ at 5 V. Any combination where the difference between V_- and V_+ is at least 4 V and no greater than 36 V is within the normal operating capabilities of these devices.

9 Application and Implementation

9.1 Application Information

The OPAx180 family offers excellent dc precision and ac performance. These devices operate up to 36-V supply rails and offer rail-to-rail output, ultra-low offset voltage, and offset voltage drift as well as 2-MHz bandwidth. These features make the OPAx180 a robust, high-performance amplifier for high-voltage industrial applications.

9.2 Typical Applications

These application examples highlight only a few of the circuits where the OPAx180 can be used.

9.2.1 Bipolar ± 10 -V Analog Output from a Unipolar Voltage Output DAC

This design is used for conditioning a unipolar digital-to-analog converter (DAC) into an accurate bipolar signal source using the OPA180 and three resistors. The circuit is designed with reactive load stability in mind and is compensated to drive nearly any conventional capacitive load associated with long cable lengths.

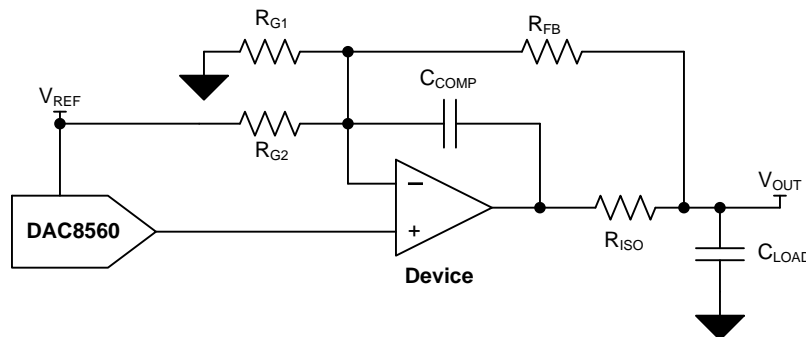

Figure 30. Circuit Schematic

9.2.1.1 Design Requirements

The design requirements are as follows:

- DAC supply voltage: +5-V dc
- Amplifier supply voltage: ± 15 -V dc
- Input: 3-wire, 24-bit SPI
- Output: ± 10 -V dc

9.2.1.2 Detailed Design Procedure

9.2.1.2.1 Component Selection

DAC: For convenience, devices with an external reference option or devices with accessible internal references are desirable in this application because the reference is used to create an offset. The DAC selection in this design should primarily be based on dc error contributions typically described by offset error, gain error, and integral nonlinearity error. Occasionally, additional specifications are provided that summarize end-point errors of the DAC typically called zero-code and full-scale errors. For ac applications, additional consideration may be placed on slew rate and settling time.

Amplifier: Amplifier input offset voltage (V_{IO}) is a key consideration for this design. V_{IO} of an operational amplifier is a typical data sheet specification but in-circuit performance is also affected by drift over temperature, the common-mode rejection ratio (CMRR), and power-supply rejection ratio (PSRR); thus consideration should be given to these parameters as well. For ac operation, additional considerations should be made concerning slew rate and settling time. Input bias current (I_{IB}) can also be a factor, but typically the resistor network is implemented with sufficiently small resistor values that the effects of input bias current are negligible.

Typical Applications (continued)

Passive: Resistor matching for the op-amp resistor network is critical for the success of this design and components should be chosen with tight tolerances. For this design 0.1% resistor values are implemented but this constraint may be adjusted based on application-specific design goals. Resistor matching contributes to both offset error and gain error in this design; see the [TI Precision Design TIPD125, Bipolar \$\pm 10V\$ Analog Output from a Unipolar Voltage Output DAC](#) for further details. The tolerance of stability components RISO and CCOMP is not critical and 1% components are acceptable.

9.2.1.3 Application Curves

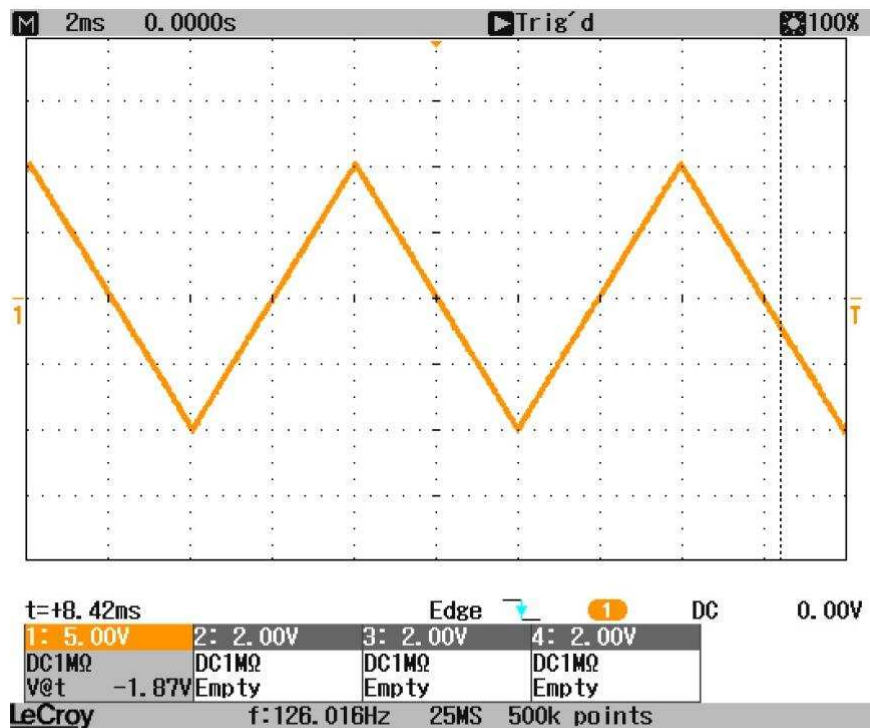

Figure 31. Full-Scale Output Waveform

Typical Applications (continued)

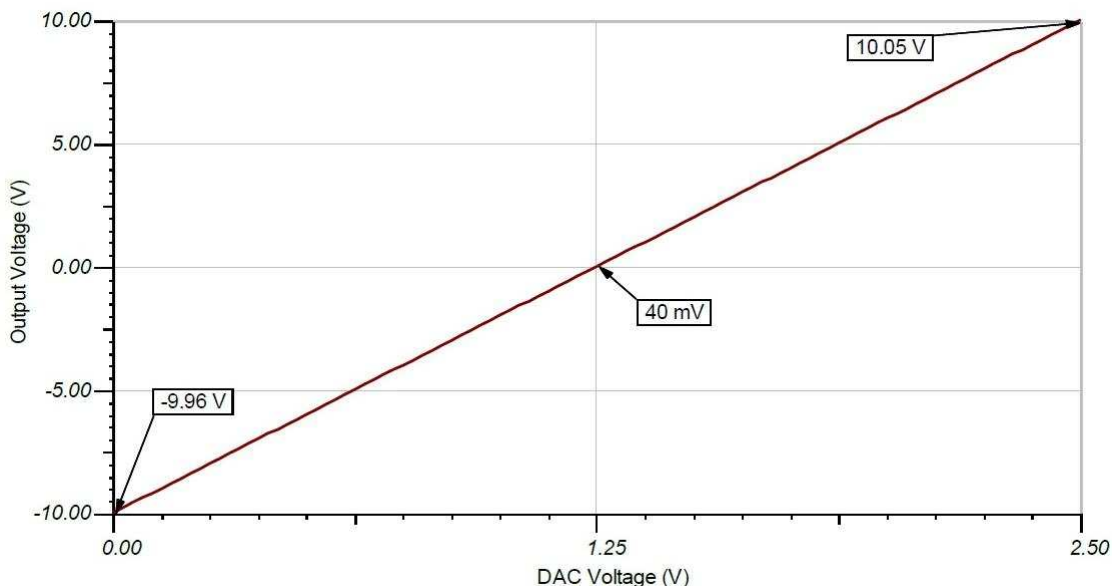

Figure 32. DC Transfer Characteristic



For step-by-step design procedure, circuit schematics, bill of materials, PCB files, simulation results, and test results, refer to [TI Precision Design T1PD125, Bipolar ±10V Analog Output from a Unipolar Voltage Output DAC](#)

9.2.2 Discrete INA + Attenuation

The OPA180 can be used as a high-voltage, high-impedance front-end for a precision, discrete instrumentation amplifier with attenuation. The INA159 provides the attenuation that allows this circuit to easily interface with 3.3-V or 5-V analog-to-digital converters (ADCs).

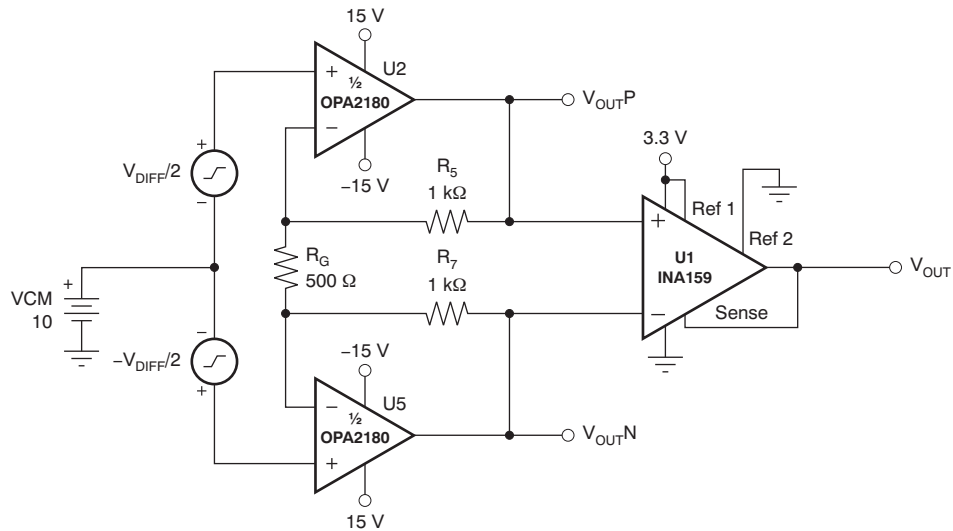
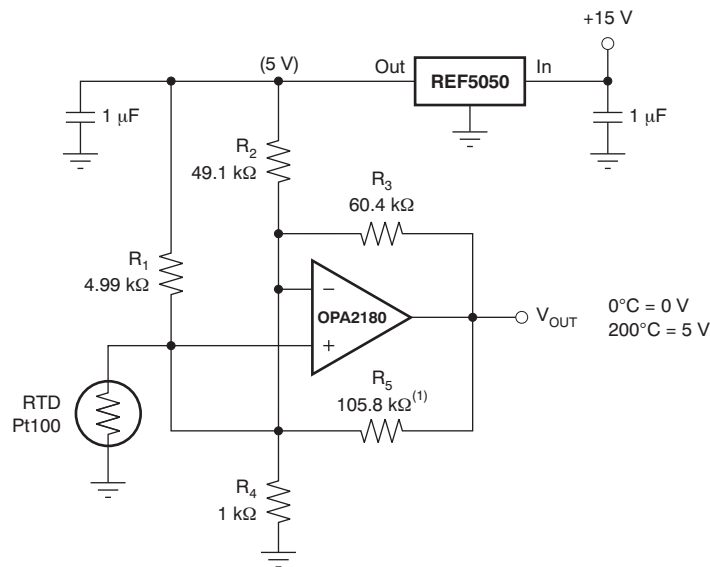

Figure 33. Discrete INA + Attenuation for ADC with 3.3-V Supply

9.2.3 RTD Amplifier

The OPA180 is excellent for use in analog linearization of resistance temperature detectors (RTDs). The below circuit combines the precision of the OPA180 amplifier and the precision reference REF5050 to linearize a Pt100 RTD.



(1) R₅ provides positive-varying excitation to linearize output.

Figure 34. RTD Amplifier with Linearization

10 Power Supply Recommendations

The OPA180 is specified for operation from 4 V to 36 V (± 2 V to ± 18 V); many specifications apply from -40°C to 105°C . Parameters that can exhibit significant variance with regard to operating voltage or temperature are presented in the [Layout](#) section.

CAUTION

Supply voltages larger than 40 V can permanently damage the device; see the [Absolute Maximum Ratings](#).

Place 0.1- μF bypass capacitors close to the power-supply pins to reduce errors coupling in from noisy or high-impedance power supplies. For more detailed information on bypass capacitor placement, refer to the [Layout](#) section.

11 Layout

11.1 Layout Guidelines

For best operational performance of the device, use good printed circuit board (PCB) layout practices, including:

- Noise can propagate into analog circuitry through the power pins of the circuit as a whole and op amp itself. Bypass capacitors are used to reduce the coupled noise by providing low-impedance power sources local to the analog circuitry.
 - Connect low-ESR, 0.1- μ F ceramic bypass capacitors between each supply pin and ground, placed as close to the device as possible. A single bypass capacitor from V+ to ground is applicable for single-supply applications.
- Separate grounding for analog and digital portions of circuitry is one of the simplest and most-effective methods of noise suppression. One or more layers on multilayer PCBs are usually devoted to ground planes. A ground plane helps distribute heat and reduces EMI noise pickup. Make sure to physically separate digital and analog grounds paying attention to the flow of the ground current. For more detailed information refer to the [Circuit Board Layout Techniques \(SLOA089\)](#).
- In order to reduce parasitic coupling, run the input traces as far away from the supply or output traces as possible. If it is not possible to keep them separate, it is much better to cross the sensitive trace perpendicular as opposed to in parallel with the noisy trace.
- Place the external components as close to the device as possible. As shown in [Figure 35](#), keeping RF and RG close to the inverting input will minimize parasitic capacitance.
- Keep the length of input traces as short as possible. Always remember that the input traces are the most sensitive part of the circuit.
- Consider a driven, low-impedance guard ring around the critical traces. A guard ring can significantly reduce leakage currents from nearby traces that are at different potentials.

11.2 Layout Example

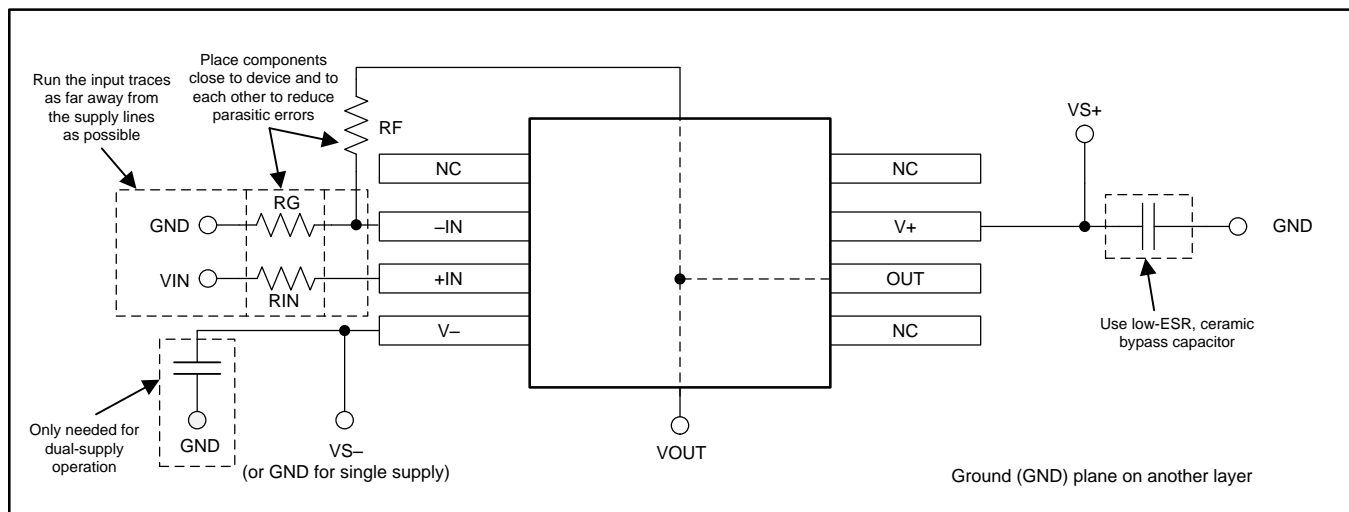
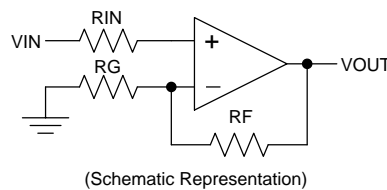

Figure 35. Operational Amplifier Board Layout for Noninverting Configuration

12 Device and Documentation Support

12.1 Related Links

The table below lists quick access links. Categories include technical documents, support and community resources, tools and software, and quick access to sample or buy.

Table 2. Related Links

PARTS	PRODUCT FOLDER	SAMPLE & BUY	TECHNICAL DOCUMENTS	TOOLS & SOFTWARE	SUPPORT & COMMUNITY
OPA180	Click here	Click here	Click here	Click here	Click here
OPA2180	Click here	Click here	Click here	Click here	Click here
OPA4180	Click here	Click here	Click here	Click here	Click here

12.2 Trademarks

All trademarks are the property of their respective owners.

12.3 Electrostatic Discharge Caution



These devices have limited built-in ESD protection. The leads should be shorted together or the device placed in conductive foam during storage or handling to prevent electrostatic damage to the MOS gates.

12.4 Glossary

[SLYZ022](#) — *TI Glossary*.

This glossary lists and explains terms, acronyms and definitions.

13 Mechanical, Packaging, and Orderable Information

The following pages include mechanical, packaging, and orderable information. This information is the most current data available for the designated devices. This data is subject to change without notice and revision of this document. For browser-based versions of this data sheet, refer to the left-hand navigation.

PACKAGING INFORMATION

Orderable Device	Status (1)	Package Type	Package Drawing	Pins	Package Qty	Eco Plan (2)	Lead/Ball Finish (6)	MSL Peak Temp (3)	Op Temp (°C)	Device Marking (4/5)	Samples
OPA180ID	ACTIVE	SOIC	D	8	75	Green (RoHS & no Sb/Br)	CU NIPDAU	Level-2-260C-1 YEAR	-40 to 105	OPA180	Samples
OPA180IDBVR	ACTIVE	SOT-23	DBV	5	3000	Green (RoHS & no Sb/Br)	CU NIPDAU	Level-2-260C-1 YEAR	-40 to 105	SHJ	Samples
OPA180IDBVT	ACTIVE	SOT-23	DBV	5	250	Green (RoHS & no Sb/Br)	CU NIPDAU	Level-2-260C-1 YEAR	-40 to 105	SHJ	Samples
OPA180IDGKR	ACTIVE	VSSOP	DGK	8	2500	Green (RoHS & no Sb/Br)	CU NIPDAU	Level-2-260C-1 YEAR	-40 to 105	SHK	Samples
OPA180IDGKT	ACTIVE	VSSOP	DGK	8	250	Green (RoHS & no Sb/Br)	CU NIPDAU	Level-2-260C-1 YEAR	-40 to 105	SHK	Samples
OPA180IDR	ACTIVE	SOIC	D	8	2500	Green (RoHS & no Sb/Br)	CU NIPDAU	Level-2-260C-1 YEAR	-40 to 105	OPA180	Samples
OPA2180ID	ACTIVE	SOIC	D	8	75	Green (RoHS & no Sb/Br)	CU NIPDAU	Level-2-260C-1 YEAR	-40 to 105	2180	Samples
OPA2180IDGK	ACTIVE	VSSOP	DGK	8	80	Green (RoHS & no Sb/Br)	CU NIPDAUAG	Level-2-260C-1 YEAR	-40 to 105	2180	Samples
OPA2180IDGKR	ACTIVE	VSSOP	DGK	8	2500	Green (RoHS & no Sb/Br)	CU NIPDAUAG	Level-2-260C-1 YEAR	-40 to 105	2180	Samples
OPA2180IDR	ACTIVE	SOIC	D	8	2500	Green (RoHS & no Sb/Br)	CU NIPDAU	Level-2-260C-1 YEAR	-40 to 105	2180	Samples
OPA4180ID	ACTIVE	SOIC	D	14	50	Green (RoHS & no Sb/Br)	CU NIPDAU	Level-2-260C-1 YEAR	-40 to 105	OPA4180	Samples
OPA4180IDR	ACTIVE	SOIC	D	14	2500	Green (RoHS & no Sb/Br)	CU NIPDAU	Level-2-260C-1 YEAR	-40 to 105	OPA4180	Samples
OPA4180IPW	ACTIVE	TSSOP	PW	14	90	Green (RoHS & no Sb/Br)	CU NIPDAU	Level-2-260C-1 YEAR	-40 to 105	OPA4180	Samples
OPA4180IPWR	ACTIVE	TSSOP	PW	14	2000	Green (RoHS & no Sb/Br)	CU NIPDAU	Level-2-260C-1 YEAR	-40 to 105	OPA4180	Samples

(1) The marketing status values are defined as follows:

ACTIVE: Product device recommended for new designs.

LIFEBUY: TI has announced that the device will be discontinued, and a lifetime-buy period is in effect.

NRND: Not recommended for new designs. Device is in production to support existing customers, but TI does not recommend using this part in a new design.

PREVIEW: Device has been announced but is not in production. Samples may or may not be available.

OBSELETE: TI has discontinued the production of the device.

(2) Eco Plan - The planned eco-friendly classification: Pb-Free (RoHS), Pb-Free (RoHS Exempt), or Green (RoHS & no Sb/Br) - please check <http://www.ti.com/productcontent> for the latest availability information and additional product content details.

TBD: The Pb-Free/Green conversion plan has not been defined.

Pb-Free (RoHS): TI's terms "Lead-Free" or "Pb-Free" mean semiconductor products that are compatible with the current RoHS requirements for all 6 substances, including the requirement that lead not exceed 0.1% by weight in homogeneous materials. Where designed to be soldered at high temperatures, TI Pb-Free products are suitable for use in specified lead-free processes.

Pb-Free (RoHS Exempt): This component has a RoHS exemption for either 1) lead-based flip-chip solder bumps used between the die and package, or 2) lead-based die adhesive used between the die and leadframe. The component is otherwise considered Pb-Free (RoHS compatible) as defined above.

Green (RoHS & no Sb/Br): TI defines "Green" to mean Pb-Free (RoHS compatible), and free of Bromine (Br) and Antimony (Sb) based flame retardants (Br or Sb do not exceed 0.1% by weight in homogeneous material)

(3) MSL, Peak Temp. - The Moisture Sensitivity Level rating according to the JEDEC industry standard classifications, and peak solder temperature.

(4) There may be additional marking, which relates to the logo, the lot trace code information, or the environmental category on the device.

(5) Multiple Device Markings will be inside parentheses. Only one Device Marking contained in parentheses and separated by a "~" will appear on a device. If a line is indented then it is a continuation of the previous line and the two combined represent the entire Device Marking for that device.

(6) Lead/Ball Finish - Orderable Devices may have multiple material finish options. Finish options are separated by a vertical ruled line. Lead/Ball Finish values may wrap to two lines if the finish value exceeds the maximum column width.

Important Information and Disclaimer: The information provided on this page represents TI's knowledge and belief as of the date that it is provided. TI bases its knowledge and belief on information provided by third parties, and makes no representation or warranty as to the accuracy of such information. Efforts are underway to better integrate information from third parties. TI has taken and continues to take reasonable steps to provide representative and accurate information but may not have conducted destructive testing or chemical analysis on incoming materials and chemicals. TI and TI suppliers consider certain information to be proprietary, and thus CAS numbers and other limited information may not be available for release.

In no event shall TI's liability arising out of such information exceed the total purchase price of the TI part(s) at issue in this document sold by TI to Customer on an annual basis.

TAPE AND REEL INFORMATION

QUADRANT ASSIGNMENTS FOR PIN 1 ORIENTATION IN TAPE

*All dimensions are nominal

Device	Package Type	Package Drawing	Pins	SPQ	Reel Diameter (mm)	Reel Width W1 (mm)	A0 (mm)	B0 (mm)	K0 (mm)	P1 (mm)	W (mm)	Pin1 Quadrant
OPA180IDBVR	SOT-23	DBV	5	3000	180.0	8.4	3.23	3.17	1.37	4.0	8.0	Q3
OPA180IDBVT	SOT-23	DBV	5	250	180.0	8.4	3.23	3.17	1.37	4.0	8.0	Q3
OPA180IDGKR	VSSOP	DGK	8	2500	330.0	12.4	5.3	3.4	1.4	8.0	12.0	Q1
OPA180IDGKT	VSSOP	DGK	8	250	177.8	12.4	5.3	3.4	1.4	8.0	12.0	Q1
OPA180IDR	SOIC	D	8	2500	330.0	12.4	6.4	5.2	2.1	8.0	12.0	Q1
OPA2180IDGKR	VSSOP	DGK	8	2500	330.0	12.4	5.3	3.4	1.4	8.0	12.0	Q1
OPA2180IDR	SOIC	D	8	2500	330.0	12.4	6.4	5.2	2.1	8.0	12.0	Q1
OPA4180IDR	SOIC	D	14	2500	330.0	16.4	6.5	9.0	2.1	8.0	16.0	Q1
OPA4180IPWR	TSSOP	PW	14	2000	330.0	12.4	6.9	5.6	1.6	8.0	12.0	Q1

TAPE AND REEL BOX DIMENSIONS

*All dimensions are nominal

Device	Package Type	Package Drawing	Pins	SPQ	Length (mm)	Width (mm)	Height (mm)
OPA180IDBVR	SOT-23	DBV	5	3000	223.0	270.0	35.0
OPA180IDBVT	SOT-23	DBV	5	250	223.0	270.0	35.0
OPA180IDGKR	VSSOP	DGK	8	2500	346.0	346.0	29.0
OPA180IDGKT	VSSOP	DGK	8	250	223.0	270.0	35.0
OPA180IDR	SOIC	D	8	2500	367.0	367.0	35.0
OPA2180IDGKR	VSSOP	DGK	8	2500	366.0	364.0	50.0
OPA2180IDR	SOIC	D	8	2500	367.0	367.0	35.0
OPA4180IDR	SOIC	D	14	2500	367.0	367.0	38.0
OPA4180IPWR	TSSOP	PW	14	2000	367.0	367.0	35.0

D (R-PDSO-G14)

PLASTIC SMALL OUTLINE



- NOTES:
- A. All linear dimensions are in inches (millimeters).
 - B. This drawing is subject to change without notice.
 - Body length does not include mold flash, protrusions, or gate burrs. Mold flash, protrusions, or gate burrs shall not exceed 0.006 (0,15) each side.
 - Body width does not include interlead flash. Interlead flash shall not exceed 0.017 (0,43) each side.
 - E. Reference JEDEC MS-012 variation AB.

D (R-PDSO-G14)

PLASTIC SMALL OUTLINE



4211283-3/E 08/12

- NOTES:
- All linear dimensions are in millimeters.
 - This drawing is subject to change without notice.
 - Publication IPC-7351 is recommended for alternate designs.
 - Laser cutting apertures with trapezoidal walls and also rounding corners will offer better paste release. Customers should contact their board assembly site for stencil design recommendations. Refer to IPC-7525 for other stencil recommendations.
 - Customers should contact their board fabrication site for solder mask tolerances between and around signal pads.

PW (R-PDSO-G14)

PLASTIC SMALL OUTLINE



- NOTES:
- A. All linear dimensions are in millimeters. Dimensioning and tolerancing per ASME Y14.5M-1994.
 - B. This drawing is subject to change without notice.
 - C. Body length does not include mold flash, protrusions, or gate burrs. Mold flash, protrusions, or gate burrs shall not exceed 0,15 each side.
 - D. Body width does not include interlead flash. Interlead flash shall not exceed 0,25 each side.
 - E. Falls within JEDEC MO-153

PW (R-PDSO-G14)

PLASTIC SMALL OUTLINE





- NOTES:
- All linear dimensions are in millimeters.
 - This drawing is subject to change without notice.
 - Publication IPC-7351 is recommended for alternate designs.
 - Laser cutting apertures with trapezoidal walls and also rounding corners will offer better paste release. Customers should contact their board assembly site for stencil design recommendations. Refer to IPC-7525 for other stencil recommendations.
 - Customers should contact their board fabrication site for solder mask tolerances between and around signal pads.

D (R-PDSO-G8)

PLASTIC SMALL OUTLINE



- NOTES:
- A. All linear dimensions are in inches (millimeters).
 - B. This drawing is subject to change without notice.
 -  Body length does not include mold flash, protrusions, or gate burrs. Mold flash, protrusions, or gate burrs shall not exceed 0.006 (0,15) each side.
 -  Body width does not include interlead flash. Interlead flash shall not exceed 0.017 (0,43) each side.
 - E. Reference JEDEC MS-012 variation AA.

D (R-PDSO-G8)

PLASTIC SMALL OUTLINE

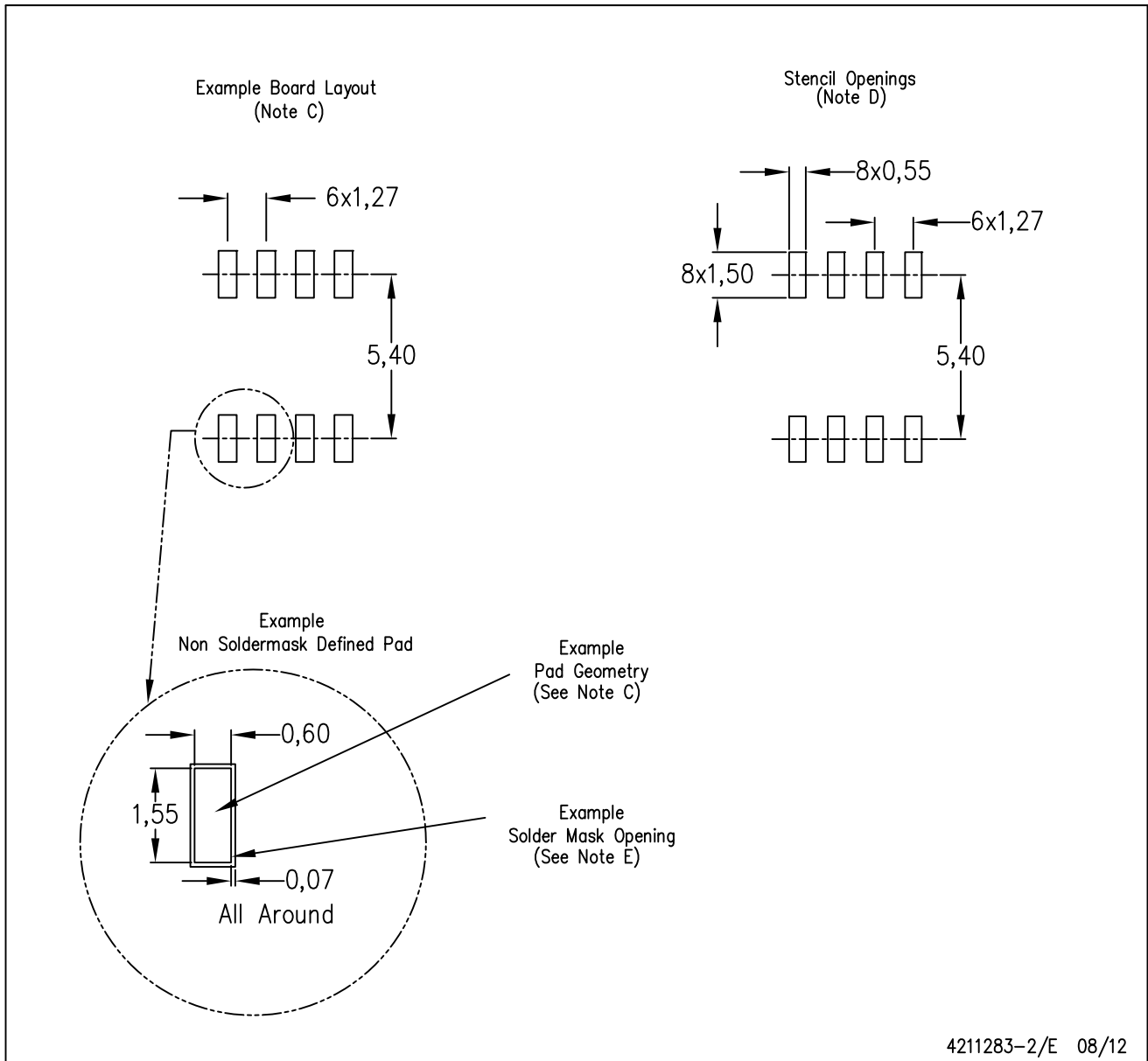

4211283-2/E 08/12

- NOTES:
- A. All linear dimensions are in millimeters.
 - B. This drawing is subject to change without notice.
 - C. Publication IPC-7351 is recommended for alternate designs.
 - D. Laser cutting apertures with trapezoidal walls and also rounding corners will offer better paste release. Customers should contact their board assembly site for stencil design recommendations. Refer to IPC-7525 for other stencil recommendations.
 - E. Customers should contact their board fabrication site for solder mask tolerances between and around signal pads.

DBV (R-PDSO-G5)

PLASTIC SMALL-OUTLINE PACKAGE



- NOTES:
- A. All linear dimensions are in millimeters.
 - B. This drawing is subject to change without notice.
 - C. Body dimensions do not include mold flash or protrusion. Mold flash and protrusion shall not exceed 0.15 per side.
 - D. Falls within JEDEC MO-178 Variation AA.

DBV (R-PDSO-G5)

PLASTIC SMALL OUTLINE



- NOTES:
- A. All linear dimensions are in millimeters.
 - B. This drawing is subject to change without notice.
 - C. Customers should place a note on the circuit board fabrication drawing not to alter the center solder mask defined pad.
 - D. Publication IPC-7351 is recommended for alternate designs.
 - E. Laser cutting apertures with trapezoidal walls and also rounding corners will offer better paste release. Customers should contact their board assembly site for stencil design recommendations. Example stencil design based on a 50% volumetric metal load solder paste. Refer to IPC-7525 for other stencil recommendations.



- NOTES:
- A. All linear dimensions are in millimeters.
 - B. This drawing is subject to change without notice.
 - C. Publication IPC-7351 is recommended for alternate designs.
 - D. Laser cutting apertures with trapezoidal walls and also rounding corners will offer better paste release. Customers should contact their board assembly site for stencil design recommendations. Refer to IPC-7525 for other stencil recommendations.
 - E. Customers should contact their board fabrication site for solder mask tolerances between and around signal pads.

IMPORTANT NOTICE

Texas Instruments Incorporated (TI) reserves the right to make corrections, enhancements, improvements and other changes to its semiconductor products and services per JESD46, latest issue, and to discontinue any product or service per JESD48, latest issue. Buyers should obtain the latest relevant information before placing orders and should verify that such information is current and complete.

TI's published terms of sale for semiconductor products (<http://www.ti.com/sc/docs/stdterms.htm>) apply to the sale of packaged integrated circuit products that TI has qualified and released to market. Additional terms may apply to the use or sale of other types of TI products and services.

Reproduction of significant portions of TI information in TI data sheets is permissible only if reproduction is without alteration and is accompanied by all associated warranties, conditions, limitations, and notices. TI is not responsible or liable for such reproduced documentation. Information of third parties may be subject to additional restrictions. Resale of TI products or services with statements different from or beyond the parameters stated by TI for that product or service voids all express and any implied warranties for the associated TI product or service and is an unfair and deceptive business practice. TI is not responsible or liable for any such statements.

Buyers and others who are developing systems that incorporate TI products (collectively, "Designers") understand and agree that Designers remain responsible for using their independent analysis, evaluation and judgment in designing their applications and that Designers have full and exclusive responsibility to assure the safety of Designers' applications and compliance of their applications (and of all TI products used in or for Designers' applications) with all applicable regulations, laws and other applicable requirements. Designer represents that, with respect to their applications, Designer has all the necessary expertise to create and implement safeguards that (1) anticipate dangerous consequences of failures, (2) monitor failures and their consequences, and (3) lessen the likelihood of failures that might cause harm and take appropriate actions. Designer agrees that prior to using or distributing any applications that include TI products, Designer will thoroughly test such applications and the functionality of such TI products as used in such applications.

TI's provision of technical, application or other design advice, quality characterization, reliability data or other services or information, including, but not limited to, reference designs and materials relating to evaluation modules, (collectively, "TI Resources") are intended to assist designers who are developing applications that incorporate TI products; by downloading, accessing or using TI Resources in any way, Designer (individually or, if Designer is acting on behalf of a company, Designer's company) agrees to use any particular TI Resource solely for this purpose and subject to the terms of this Notice.

TI's provision of TI Resources does not expand or otherwise alter TI's applicable published warranties or warranty disclaimers for TI products, and no additional obligations or liabilities arise from TI providing such TI Resources. TI reserves the right to make corrections, enhancements, improvements and other changes to its TI Resources. TI has not conducted any testing other than that specifically described in the published documentation for a particular TI Resource.

Designer is authorized to use, copy and modify any individual TI Resource only in connection with the development of applications that include the TI product(s) identified in such TI Resource. NO OTHER LICENSE, EXPRESS OR IMPLIED, BY ESTOPPEL OR OTHERWISE TO ANY OTHER TI INTELLECTUAL PROPERTY RIGHT, AND NO LICENSE TO ANY TECHNOLOGY OR INTELLECTUAL PROPERTY RIGHT OF TI OR ANY THIRD PARTY IS GRANTED HEREIN, including but not limited to any patent right, copyright, mask work right, or other intellectual property right relating to any combination, machine, or process in which TI products or services are used. Information regarding or referencing third-party products or services does not constitute a license to use such products or services, or a warranty or endorsement thereof. Use of TI Resources may require a license from a third party under the patents or other intellectual property of the third party, or a license from TI under the patents or other intellectual property of TI.

TI RESOURCES ARE PROVIDED "AS IS" AND WITH ALL FAULTS. TI DISCLAIMS ALL OTHER WARRANTIES OR REPRESENTATIONS, EXPRESS OR IMPLIED, REGARDING RESOURCES OR USE THEREOF, INCLUDING BUT NOT LIMITED TO ACCURACY OR COMPLETENESS, TITLE, ANY EPIDEMIC FAILURE WARRANTY AND ANY IMPLIED WARRANTIES OF MERCHANTABILITY, FITNESS FOR A PARTICULAR PURPOSE, AND NON-INFRINGEMENT OF ANY THIRD PARTY INTELLECTUAL PROPERTY RIGHTS. TI SHALL NOT BE LIABLE FOR AND SHALL NOT DEFEND OR INDEMNIFY DESIGNER AGAINST ANY CLAIM, INCLUDING BUT NOT LIMITED TO ANY INFRINGEMENT CLAIM THAT RELATES TO OR IS BASED ON ANY COMBINATION OF PRODUCTS EVEN IF DESCRIBED IN TI RESOURCES OR OTHERWISE. IN NO EVENT SHALL TI BE LIABLE FOR ANY ACTUAL, DIRECT, SPECIAL, COLLATERAL, INDIRECT, PUNITIVE, INCIDENTAL, CONSEQUENTIAL OR EXEMPLARY DAMAGES IN CONNECTION WITH OR ARISING OUT OF TI RESOURCES OR USE THEREOF, AND REGARDLESS OF WHETHER TI HAS BEEN ADVISED OF THE POSSIBILITY OF SUCH DAMAGES.

Unless TI has explicitly designated an individual product as meeting the requirements of a particular industry standard (e.g., ISO/TS 16949 and ISO 26262), TI is not responsible for any failure to meet such industry standard requirements.

Where TI specifically promotes products as facilitating functional safety or as compliant with industry functional safety standards, such products are intended to help enable customers to design and create their own applications that meet applicable functional safety standards and requirements. Using products in an application does not by itself establish any safety features in the application. Designers must ensure compliance with safety-related requirements and standards applicable to their applications. Designer may not use any TI products in life-critical medical equipment unless authorized officers of the parties have executed a special contract specifically governing such use. Life-critical medical equipment is medical equipment where failure of such equipment would cause serious bodily injury or death (e.g., life support, pacemakers, defibrillators, heart pumps, neurostimulators, and implantables). Such equipment includes, without limitation, all medical devices identified by the U.S. Food and Drug Administration as Class III devices and equivalent classifications outside the U.S.

TI may expressly designate certain products as completing a particular qualification (e.g., Q100, Military Grade, or Enhanced Product). Designers agree that it has the necessary expertise to select the product with the appropriate qualification designation for their applications and that proper product selection is at Designers' own risk. Designers are solely responsible for compliance with all legal and regulatory requirements in connection with such selection.

Designer will fully indemnify TI and its representatives against any damages, costs, losses, and/or liabilities arising out of Designer's non-compliance with the terms and provisions of this Notice.