

## 3V-17V 1A Step-Down Converters with DCS-Control™

Check for Samples: [TPS62160](#), [TPS62161](#), [TPS62162](#), [TPS62163](#)

### FEATURES

- DCS-Control™ Topology
- Input Voltage Range: 3 to 17 V
- Up to 1A Output Current
- Adjustable Output Voltage from 0.9 to 6 V
- Fixed Output Voltage Versions
- Seamless Power Save Mode Transition
- Typically 17µA Quiescent Current
- Power Good Output
- 100% Duty Cycle Mode
- Short Circuit Protection
- Over Temperature Protection
- Available in MSOP-8 and 2×2 mm WSON-8 Packages

### APPLICATIONS

- Standard 12V Rail Supplies
- POL Supply from Single or Multiple Li-Ion Battery
- LDO Replacement
- Embedded Systems
- Digital Still Camera, Video
- Mobile PC's, Tablet, Modems

### DESCRIPTION

The TPS6216X family is an easy to use synchronous step down DC-DC converter optimized for applications with high power density. A high switching frequency of typically 2.25MHz allows the use of small inductors and provides fast transient response as well as high output voltage accuracy by utilization of the DCS-Control topology.

With its wide operating input voltage range of 3V to 17V, the devices are ideally suited for systems powered from either a Li-Ion or other battery as well as from 12V intermediate power rails. It supports up to 1A continuous output current at output voltages between 0.9V and 6V (with 100% duty cycle mode).

Power sequencing is also possible by configuring the Enable and open-drain Power Good pins.

In Power Save Mode, the devices show quiescent current of about 17µA from VIN. Power Save Mode, entered automatically and seamlessly if load is small, maintains high efficiency over the entire load range. In Shutdown Mode, the device is turned off and shutdown current consumption is less than 2µA.

The devices, available in adjustable and fixed output voltage versions, are packaged in an 8-pin WSON package measuring 2 × 2 mm (DSG) or 8-pin MSOP package (DGK).

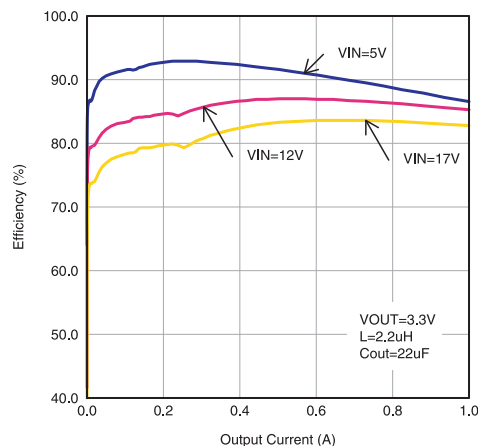
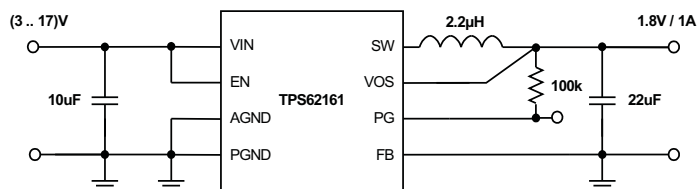

Figure 1. Typical Application and Efficiency



Please be aware that an important notice concerning availability, standard warranty, and use in critical applications of Texas Instruments semiconductor products and disclaimers thereto appears at the end of this data sheet.

DCS-Control is a trademark of Texas Instruments.



These devices have limited built-in ESD protection. The leads should be shorted together or the device placed in conductive foam during storage or handling to prevent electrostatic damage to the MOS gates.

### ORDERING INFORMATION<sup>(1)</sup>

T <sub>A</sub>	OUTPUT VOLTAGE	PART NUMBER <sup>(2)</sup>	PACKAGE	ORDERING	PACKAGE MARKING
-40°C to 85°C	adjustable	TPS62160	8-Pin WSON	TPS62160DSG	QTV
	1.8 V	TPS62161		TPS62161DSG	QUB
	3.3 V	TPS62162		TPS62162DSG	QUC
	5.0 V	TPS62163		TPS62163DSG	QUD
	adjustable	TPS62160	8-Pin MSOP	TPS62160DGK	62160

(1) For detailed ordering information please check the PACKAGE OPTION ADDENDUM section at the end of this datasheet.

(2) Contact the factory to check availability of other fixed output voltage versions.

### ABSOLUTE MAXIMUM RATINGS

over operating free-air temperature range (unless otherwise noted)<sup>(1)</sup>

		VALUE	UNIT
Pin voltage range <sup>(2)</sup>	V <sub>IN</sub>	-0.3 to 20	V
	EN, SW	-0.3 to V <sub>IN</sub> +0.3	V
	FB, PG, VOS	-0.3 to 7	V
Power Good sink current	PG	10	mA
Temperature range	Operating junction temperature range, T <sub>J</sub>	-40 to 125	°C
	Storage temperature range, T <sub>stg</sub>	-65 to 150	
ESD rating <sup>(3)</sup>	HBM Human body model	2	kV
	CDM Charge device model	0.5	kV

(1) Stresses beyond those listed under *absolute maximum ratings* may cause permanent damage to the device. These are stress ratings only, and functional operation of the device at these or any other conditions beyond those indicated under *recommended operating conditions* is not implied. Exposure to absolute-maximum-rated conditions for extended periods may affect device reliability.

(2) All voltages are with respect to network ground terminal.

(3) ESD testing is performed according to the respective JEDEC standard.

### THERMAL INFORMATION

THERMAL METRIC <sup>(1)</sup>		TPS6216X		UNITS
		DSG (8) PINS	DGK (8) PINS	
θ <sub>JA</sub>	Junction-to-ambient thermal resistance	61.8	184.3	°C/W
θ <sub>JC(TOP)</sub>	Junction-to-case(top) thermal resistance	61.3	74.6	
θ <sub>JB</sub>	Junction-to-board thermal resistance	15.5	105.8	
ψ <sub>JT</sub>	Junction-to-top characterization parameter	0.4	13.3	
ψ <sub>JB</sub>	Junction-to-board characterization parameter	15.4	104.2	
θ <sub>JC(BOTTOM)</sub>	Junction-to-case(bottom) thermal resistance	8.6	-	

(1) For more information about traditional and new thermal metrics, see the *IC Package Thermal Metrics* application report, [SPRA953](#).

### RECOMMENDED OPERATING CONDITIONS

over operating free-air temperature range (unless otherwise noted)

	MIN	TYP	MAX	UNIT
Supply Voltage, V <sub>IN</sub>	3		17	V
Operating free air temperature, T <sub>A</sub>	-40		85	°C
Operating junction temperature, T <sub>J</sub>	-40		125	°C

## ELECTRICAL CHARACTERISTICS

over free-air temperature range ( $T_A = -40^{\circ}\text{C}$  to  $+85^{\circ}\text{C}$ ), typical values at  $V_{IN} = 12\text{V}$  and  $T_A = 25^{\circ}\text{C}$  (unless otherwise noted)

PARAMETER		TEST CONDITIONS	MIN	TYP	MAX	UNIT
<b>SUPPLY</b>						
$V_{IN}$	Input Voltage Range <sup>(1)</sup>		3		17	V
$I_Q$	Operating Quiescent Current	EN=High, $I_{OUT} = 0\text{mA}$ , device not switching		17	25	$\mu\text{A}$
$I_{SD}$	Shutdown Current <sup>(2)</sup>	EN=Low		1.5	4	$\mu\text{A}$
$V_{UVLO}$	Undervoltage Lockout Threshold	Falling Input Voltage	2.6	2.7	2.82	V
		Hysteresis		180		mV
$T_{SD}$	Thermal Shutdown Temperature			160		$^{\circ}\text{C}$
	Thermal Shutdown Hysteresis			20		
<b>CONTROL (EN, PG)</b>						
$V_{EN\_H}$	High Level Input Threshold Voltage (EN)		0.9			V
$V_{EN\_L}$	Low Level Input Threshold Voltage (EN)				0.3	V
$I_{LKG\_EN}$	Input Leakage Current (EN)	EN= $V_{IN}$ or GND		0.01	1	$\mu\text{A}$
$V_{TH\_PG}$	Power Good Threshold Voltage	Rising ( $\%V_{OUT}$ )	92	95	98	%
		Falling ( $\%V_{OUT}$ )	87	90	93	
$V_{OL\_PG}$	Power Good Output Low	$I_{PG} = -2\text{mA}$		0.07	0.3	V
$I_{LKG\_PG}$	Input Leakage Current (PG)	$V_{PG} = 1.8\text{V}$		1	400	nA
<b>POWER SWITCH</b>						
$R_{DS(ON)}$	High-Side MOSFET ON-Resistance	$V_{IN} \geq 6\text{V}$		300	600	m $\Omega$
		$V_{IN} = 3\text{V}$		430		
	Low-Side MOSFET ON-Resistance	$V_{IN} \geq 6\text{V}$		120	200	m $\Omega$
		$V_{IN} = 3\text{V}$		165		
$I_{LIMF}$	High-Side MOSFET Forward Current Limit <sup>(3)</sup>	$V_{IN} = 12\text{V}$ , $T_A = 25^{\circ}\text{C}$	1.45	1.95	2.45	A
<b>OUTPUT</b>						
$V_{REF}$	Internal Reference Voltage <sup>(4)</sup>			0.8		V
$I_{LKG\_FB}$	Pin Leakage Current (FB)	TPS62160, $V_{FB} = 1.2\text{V}$		5	400	nA
$V_{OUT}$	Output Voltage Range (TPS62160)	$V_{IN} \geq V_{OUT}$	0.9		6.0	V
	Initial Output Voltage Accuracy <sup>(5)</sup>	PWM mode operation, $V_{IN} \geq V_{OUT} + 1\text{V}$	-3		3	%
		Power Save Mode operation, $C_{OUT} = 22\mu\text{F}$	-3.5		4	
	DC Output Voltage Load Regulation	$V_{IN} = 12\text{V}$ , $V_{OUT} = 3.3\text{V}$ , PWM mode operation		0.05		
DC Output Voltage Line Regulation	$3\text{V} \leq V_{IN} \leq 17\text{V}$ , $V_{OUT} = 3.3\text{V}$ , $I_{OUT} = 0.5\text{A}$ , PWM mode operation		0.02			% / V

(1) The device is still functional down to Under Voltage Lockout (see parameter  $V_{UVLO}$ ).

(2) Current into  $V_{IN}$  pin.

(3) This is the static current limit. It can be temporarily higher in applications due to internal propagation delay (see [Current Limit And Short Circuit Protection](#) section).

(4) This is the voltage regulated at the FB pin.

(5) This is the accuracy provided by the device itself (line and load regulation effects are not included). For fixed voltage versions, the (internal) resistive feedback divider is included.

## DEVICE INFORMATION

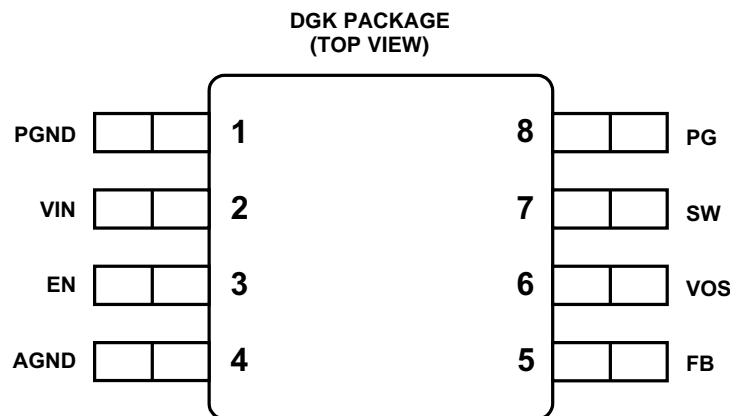
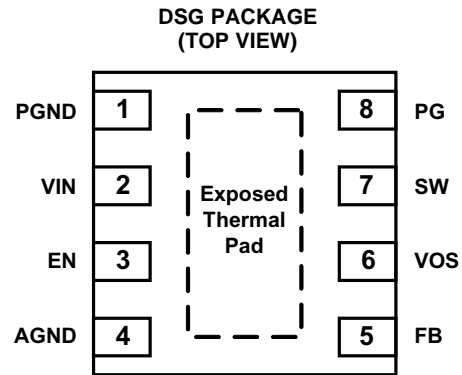

### Terminal Functions

PIN <sup>(1)</sup>		I/O	DESCRIPTION
NAME	NO.		
PGND	1		Power ground
VIN	2	I	Supply voltage
EN	3	I	Enable input (High = enabled, Low = disabled)
AGND	4		Analog Ground
FB	5	I	Voltage feedback of adjustable version. Connect resistive voltage divider to this pin. It is recommended to connect FB to AGND on fixed output voltage versions for improved thermal performance.
VOS	6	I	Output voltage sense pin and connection for the control loop circuitry.
SW	7	O	Switch node, which is connected to the internal MOSFET switches. Connect inductor between SW and output capacitor.
PG	8	O	Output power good (High = VOUT ready, Low = VOUT below nominal regulation) ; open drain (requires pull-up resistor; goes high impedance, when device is switched off)
Exposed Thermal Pad <sup>(2)</sup>			Must be connected to AGND. Must be soldered to achieve appropriate power dissipation and mechanical reliability.

(1) For more information about connecting pins, see [DETAILED DESCRIPTION](#) and [APPLICATION INFORMATION](#) sections.

(2) The exposed thermal pad is available with the DSG package only, not with DGK package.

FUNCTIONAL BLOCK DIAGRAM

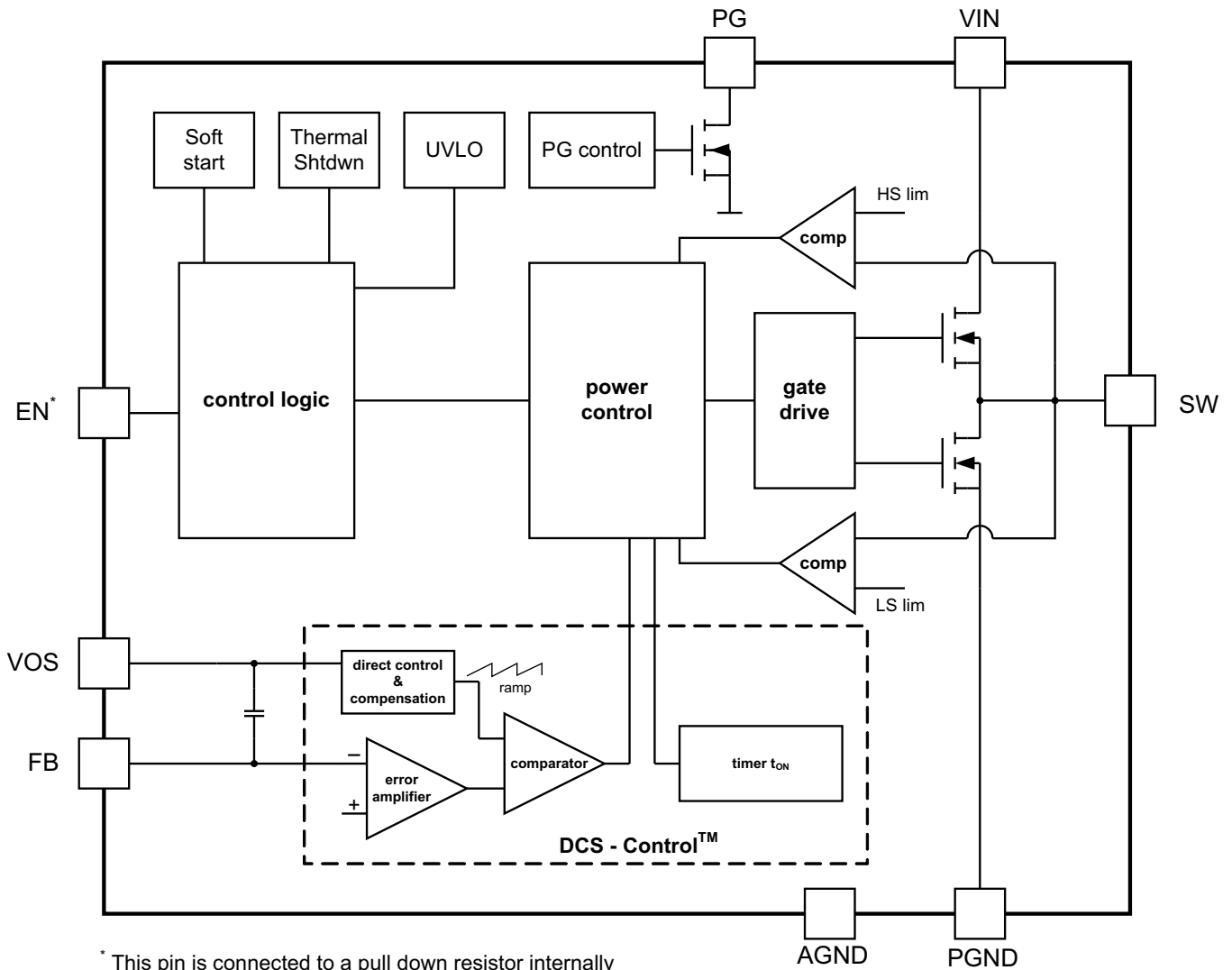
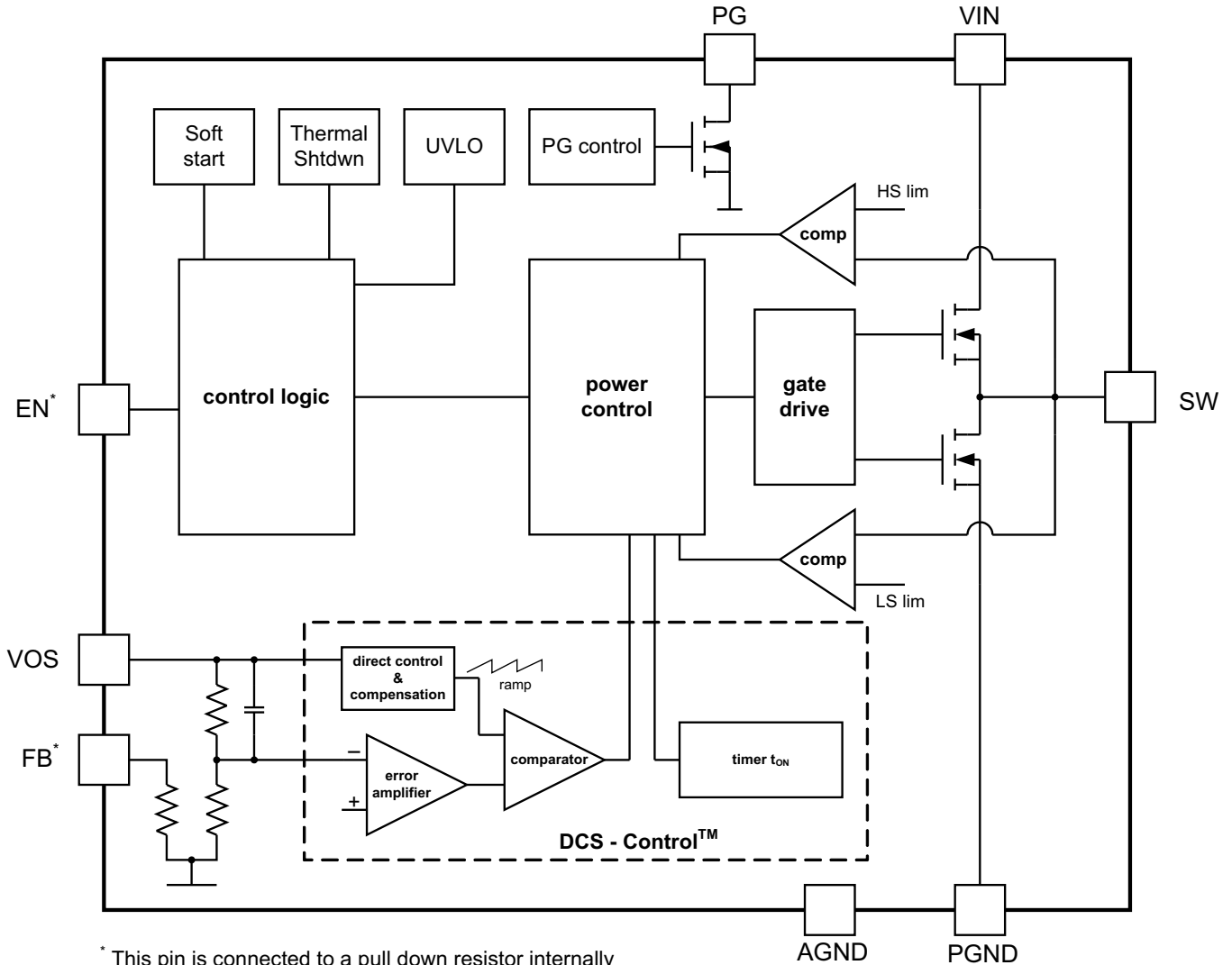

Figure 2. TPS62160 (adjustable output voltage)



\* This pin is connected to a pull down resistor internally (see Detailed Description section).

**Figure 3. TPS62161/2/3 (fixed output voltage)**

## PARAMETER MEASUREMENT INFORMATION

### List of Components

REFERENCE	DESCRIPTION	MANUFACTURER
IC	17V, 1A Step-Down Converter, WSON	TPS62160DSG, Texas Instruments
L1	2.2 $\mu$ H, 1.4A, 3 x 2.8 x 1.2 mm	VLF3012ST-2R2M1R4, TDK
Cin	10 $\mu$ F, 25V, Ceramic	Standard
Cout	22 $\mu$ F, 6.3V, Ceramic	Standard
R1	depending on Vout	
R2	depending on Vout	
R3	100k $\Omega$ , Chip, 0603, 1/16W, 1%	Standard

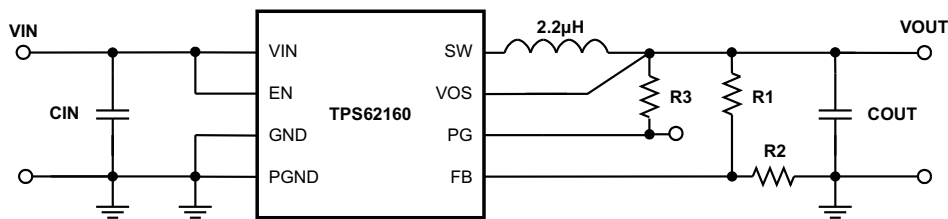
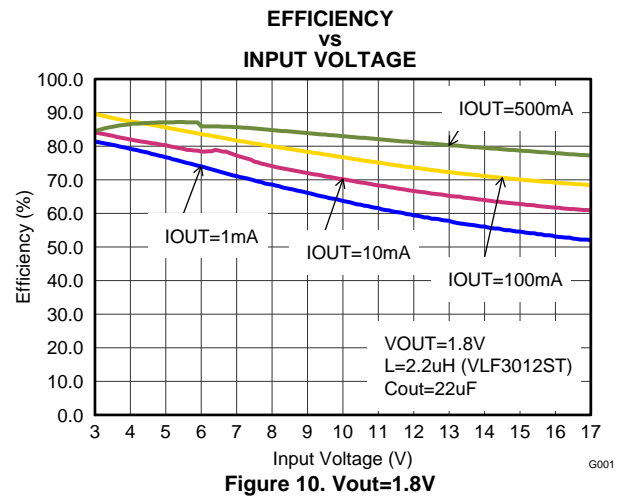
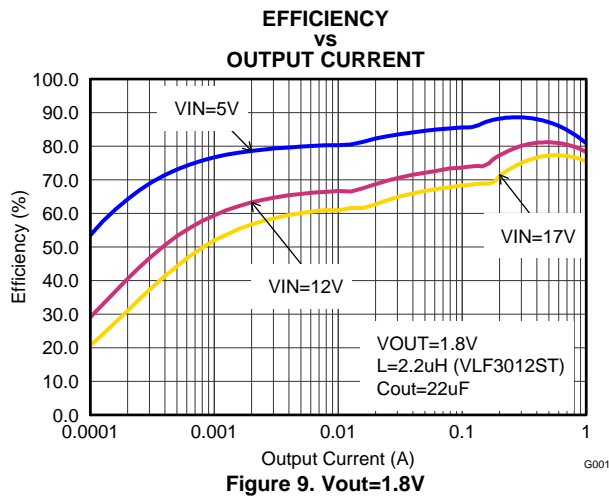
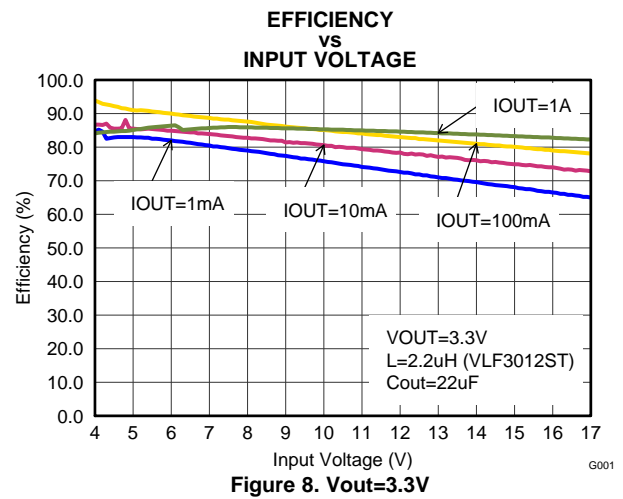
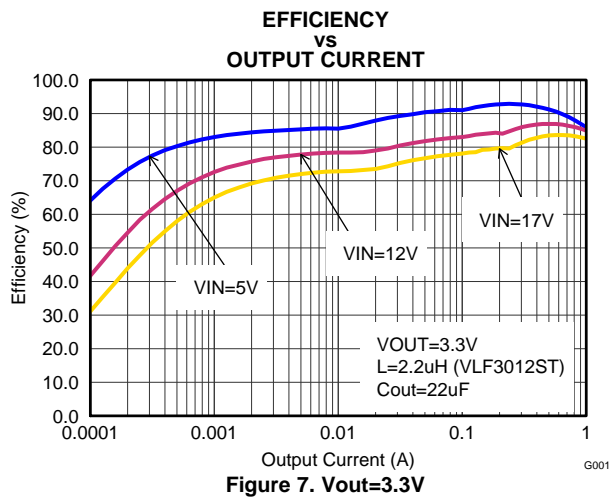
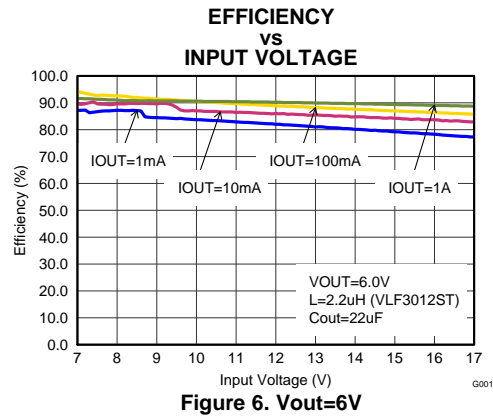
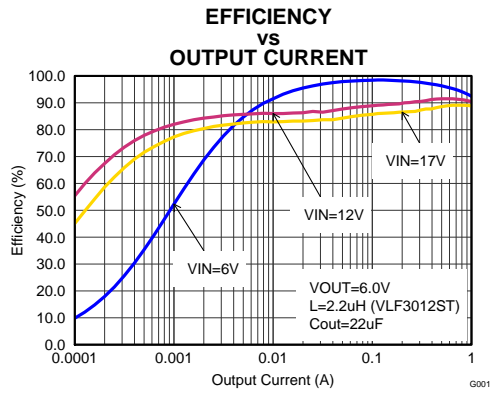

**Figure 4. Measurement Setup**

## TYPICAL CHARACTERISTICS

### Table of Graphs

	DESCRIPTION	FIGURE
Efficiency	vs Output Current, vs Input Voltage	5 - 12
Output voltage	vs Output Current (Load regulation)	13
	vs Input Voltage (Line regulation)	14
Switching Frequency	vs Input Voltage	15
	vs Output Current	16
Quiescent Current	vs Input Voltage	17
Shutdown Current	vs Input Voltage	18
Power FET RDS(on)	vs Input Voltage (High-Side, Low-Side)	19, 20
Output Voltage Ripple	vs Output Current	21
Maximum Output Current	vs Input Voltage	22
Waveforms	PWM-PSM-PWM Mode Transition	23, 24
	Load Transient Response	25 - 28
	Startup	29, 30
	Typical Power Save Mode Operation	31
	Typical PWM Mode Operation	32





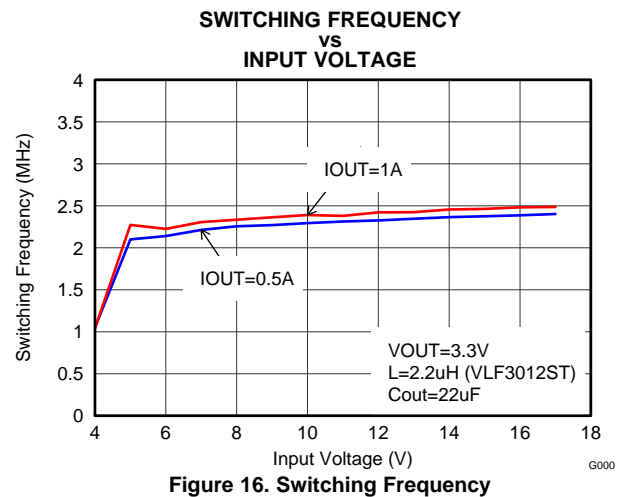
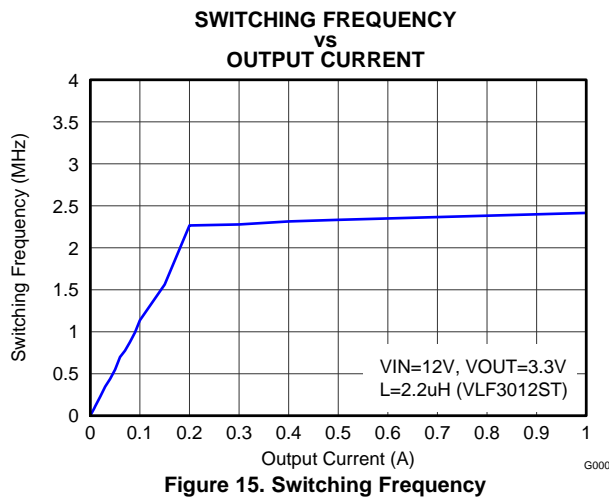
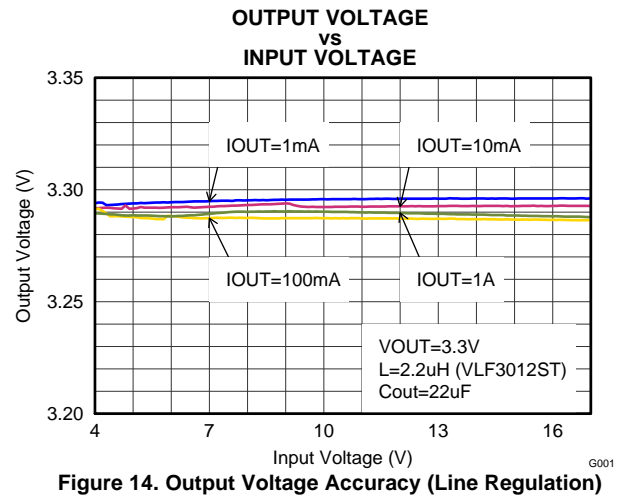
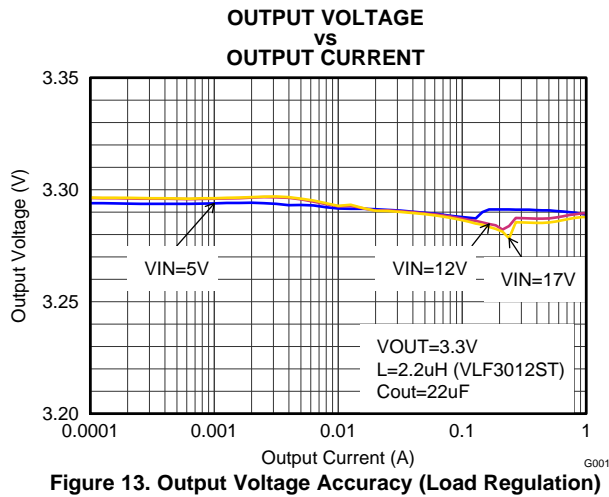
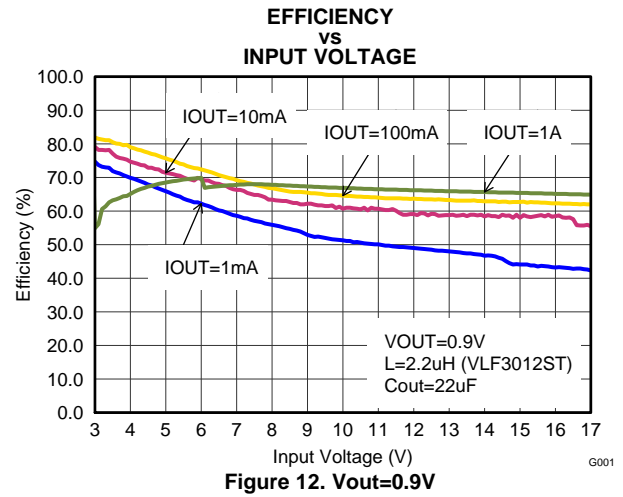
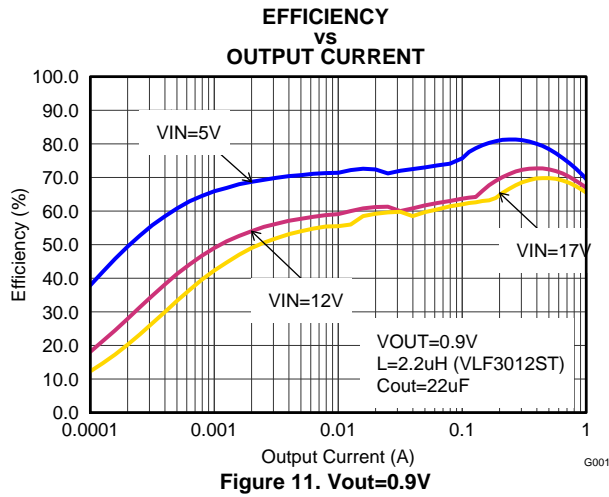

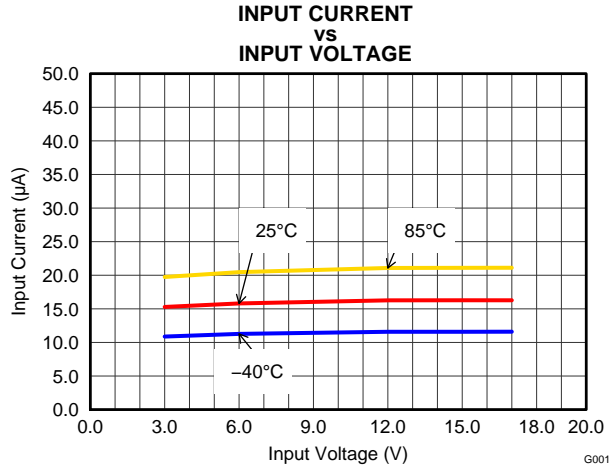

Figure 17. Quiescent Current

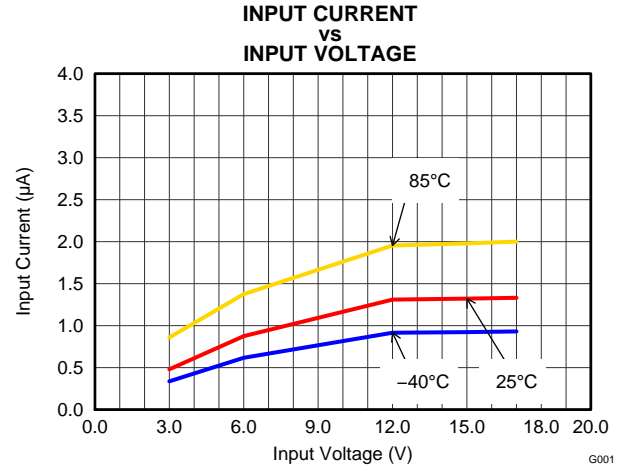

Figure 18. Shutdown Current

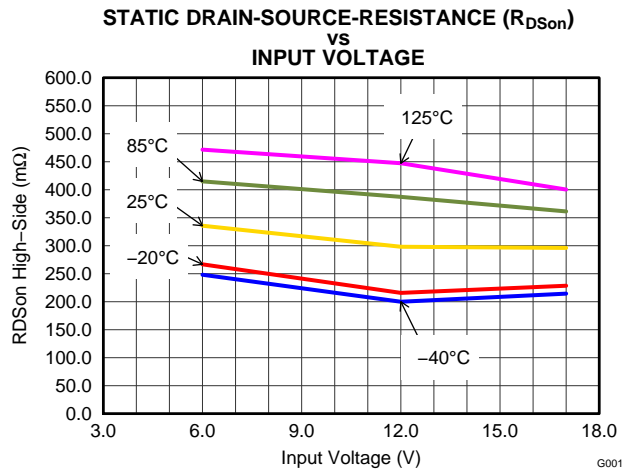

Figure 19. High-Side Switch

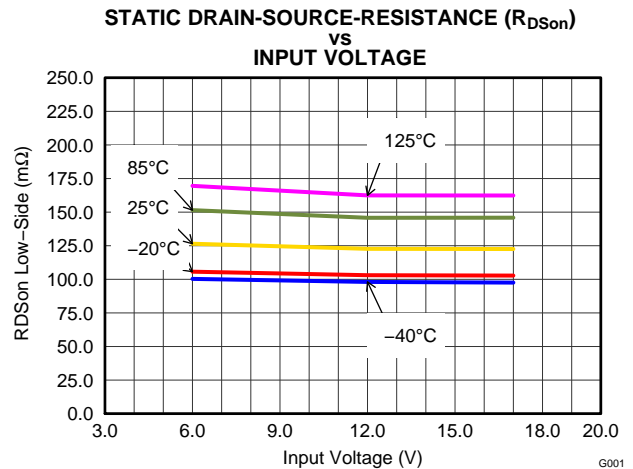

Figure 20. Low-Side Switch

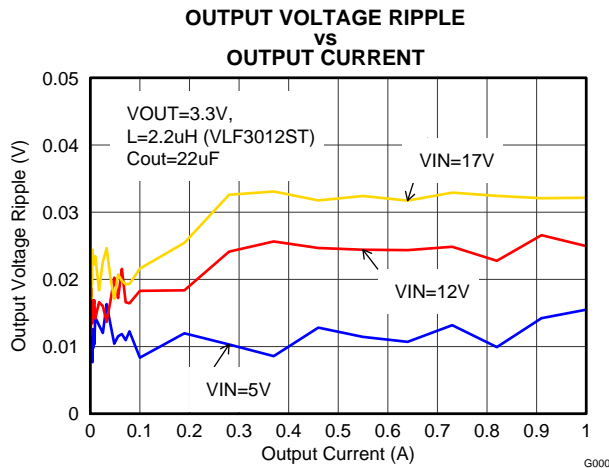

Figure 21. Output Voltage Ripple

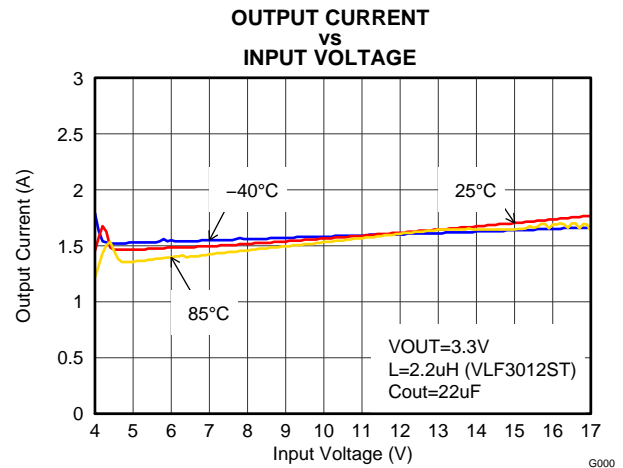

Figure 22. Maximum Output Current

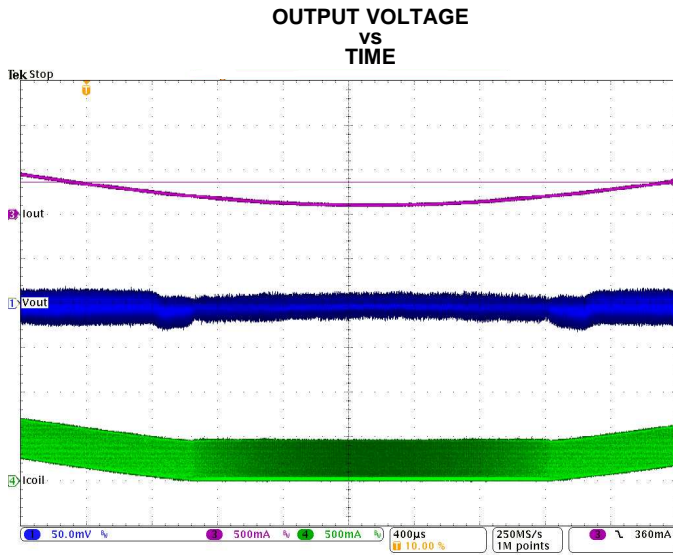

Figure 23. PWM to PSM Mode Transition

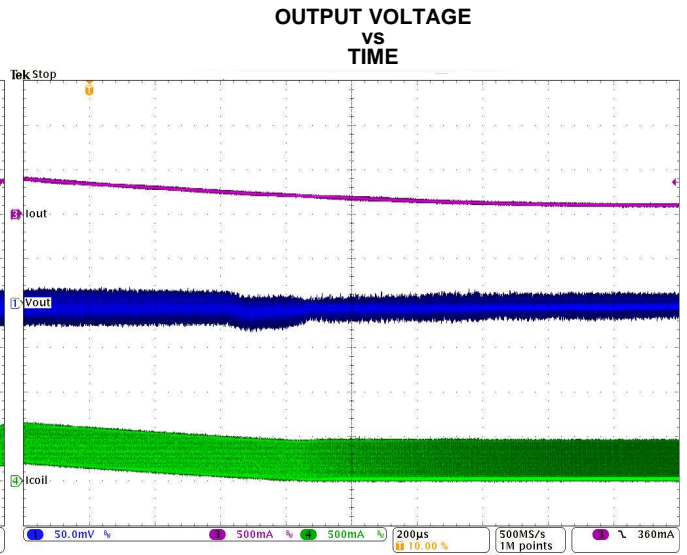

Figure 24. PSM to PWM Mode Transition

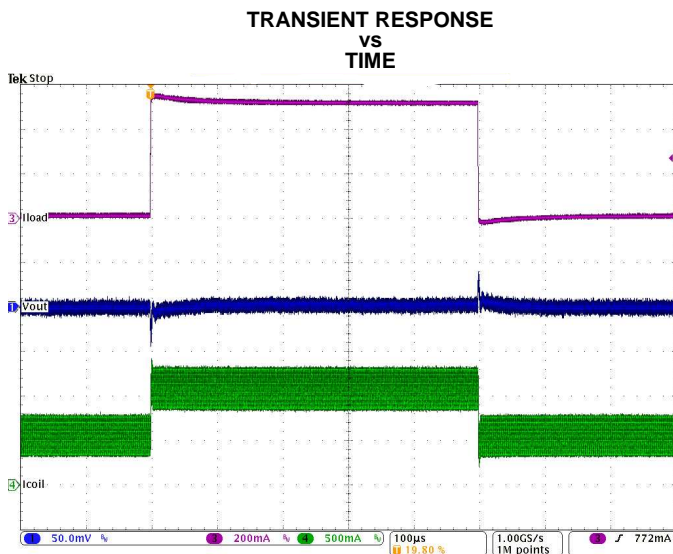

Figure 25. Load Transient Response in PWM mode (500mA to 1A)

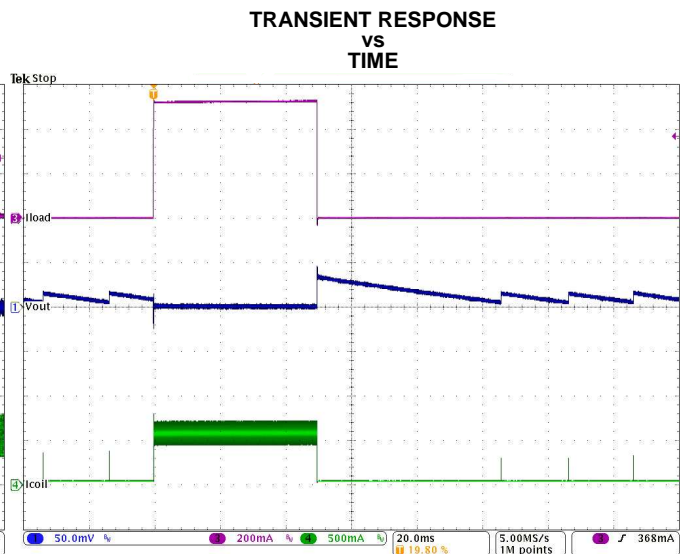

Figure 26. Load Transient Response from Power Save Mode (100mA to 500mA)

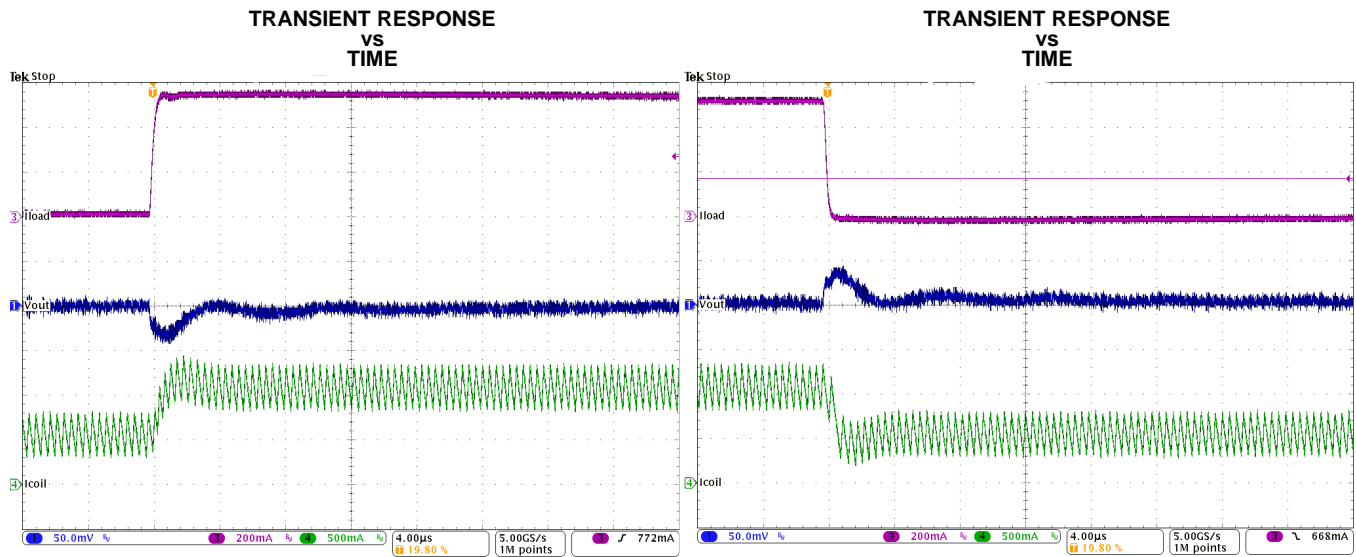

Figure 27. Load Transient Response in PWM mode (500mA to 1A), rising edge

Figure 28. Load Transient Response in PWM mode (500mA to 1A), falling edge

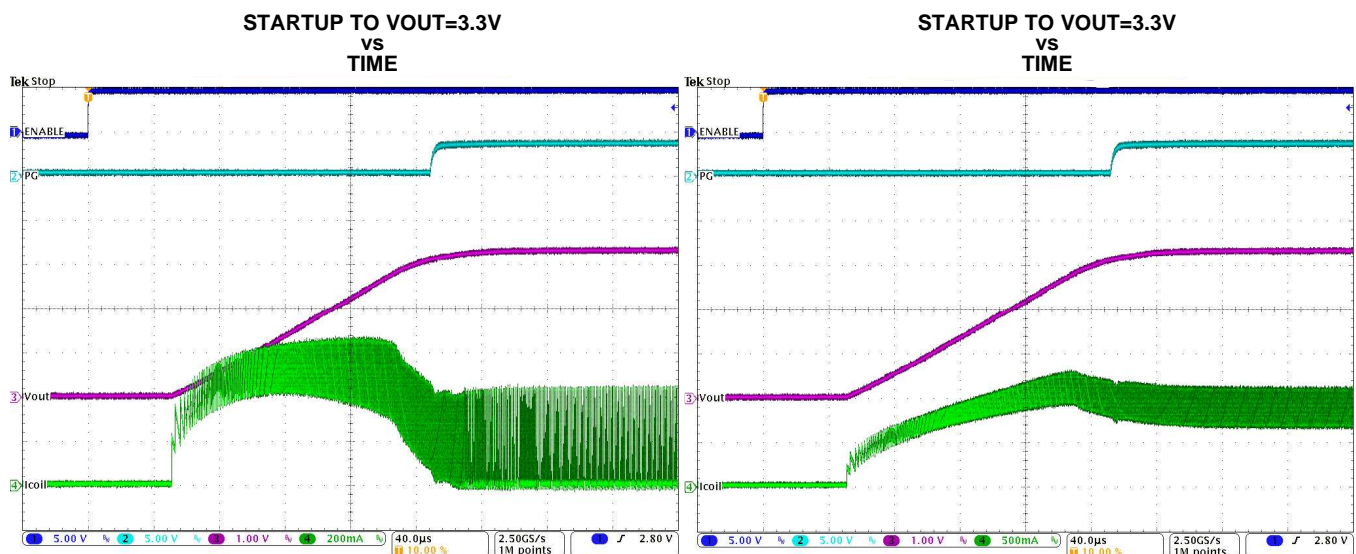

Figure 29. Startup with Iout=100mA

Figure 30. Startup with Iout=1A

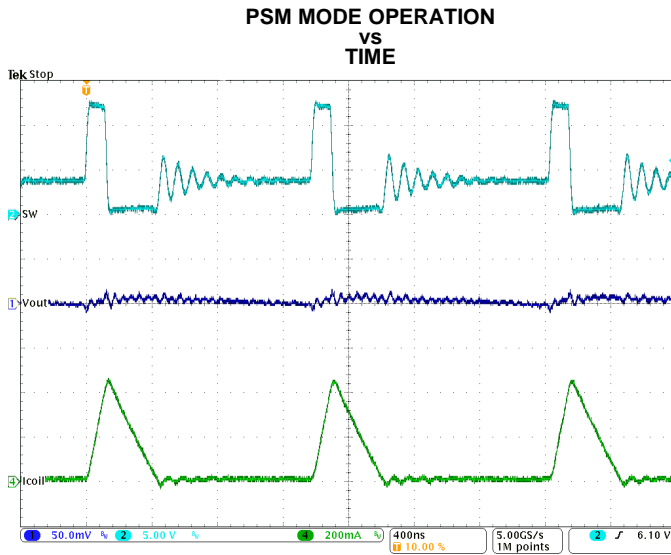

Figure 31. Typical Operation in Power Save Mode (Iout=66mA)

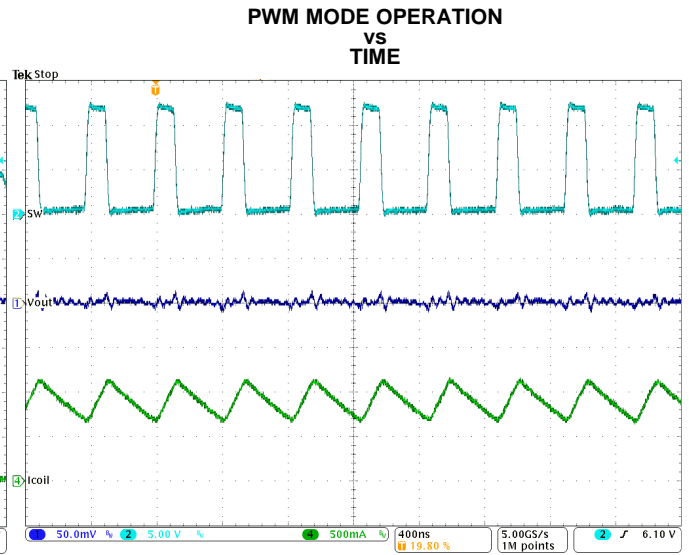

Figure 32. Typical Operation in PWM Mode (Iout=1A)

## DETAILED DESCRIPTION

### Device Operation

The TPS6216X synchronous switched mode power converters are based on DCS-Control™ (Direct Control with Seamless Transition into Power Save Mode), an advanced regulation topology, that combines the advantages of hysteretic, voltage mode and current mode control including an AC loop directly associated to the output voltage. This control loop takes information about output voltage changes and feeds it directly to a fast comparator stage. It sets the switching frequency, which is constant for steady state operating conditions, and provides immediate response to dynamic load changes. To get accurate DC load regulation, a voltage feedback loop is used. The internally compensated regulation network achieves fast and stable operation with small external components and low ESR capacitors.

The DCS-Control™ topology supports PWM (Pulse Width Modulation) mode for medium and heavy load conditions and a Power Save Mode at light loads. During PWM, it operates at its nominal switching frequency in continuous conduction mode. This frequency is typically about 2.25MHz with a controlled frequency variation depending on the input voltage. If the load current decreases, the converter enters Power Save Mode to sustain high efficiency down to very light loads. In Power Save Mode the switching frequency decreases linearly with the load current. Since DCS-Control™ supports both operation modes within one single building block, the transition from PWM to Power Save Mode is seamless without effects on the output voltage.

Fixed output voltage versions provide smallest solution size and lowest current consumption, requiring only 3 external components. An internal current limit supports nominal output currents of up to 1A.

The TPS6216X family offers both excellent DC voltage and superior load transient regulation, combined with very low output voltage ripple, minimizing interference with RF circuits.

### Pulse Width Modulation (PWM) Operation

The TPS6216X operates with pulse width modulation in continuous conduction mode (CCM) with a nominal switching frequency of about 2.25MHz. The frequency variation in PWM is controlled and depends on  $V_{IN}$ ,  $V_{OUT}$  and the inductance. The device operates in PWM mode as long the output current is higher than half the inductor's ripple current. To maintain high efficiency at light loads, the device enters Power Save Mode at the boundary to discontinuous conduction mode (DCM). This happens if the output current becomes smaller than half the inductor's ripple current.

### Power Save Operation

The TPS6216X's built in Power Save Mode will be entered seamlessly, if the load current decreases. This secures a high efficiency in light load operation. The device remains in Power Save Mode as long as the inductor current is discontinuous.

In Power Save Mode the switching frequency decreases linearly with the load current maintaining high efficiency. The transition into and out of Power Save Mode happens within the entire regulation scheme and is seamless in both directions.

The TPS6216X includes a fixed on-time circuitry. This on-time, in steady-state operation, can be estimated as:

$$t_{ON} = \frac{V_{OUT}}{V_{IN}} \cdot 420ns \quad (1)$$

For very small output voltages, the on-time increases beyond the result of [Equation 1](#), to stay above an absolute minimum on-time,  $t_{ON(min)}$ , which is around 80ns to limit switching losses. The peak inductor current in PSM can be approximated by:

$$I_{LPSM(peak)} = \frac{(V_{IN} - V_{OUT})}{L} \cdot t_{ON} \quad (2)$$

When  $V_{IN}$  decreases to typically 15% above  $V_{OUT}$ , the TPS6216X will not enter Power Save Mode, regardless of the load current. The device maintains output regulation in PWM mode.

## 100% Duty-Cycle Operation

The duty cycle of the buck converter is given by  $D=V_{out}/V_{in}$  and increases as the input voltage comes close to the output voltage. In this case, the device starts 100% duty cycle operation turning on the high-side switch 100% of the time. The high-side switch stays turned on as long as the output voltage is below the internal setpoint. This allows the conversion of small input to output voltage differences, e.g. for longest operation time of battery-powered applications. In 100% duty cycle mode, the low-side FET is switched off.

The minimum input voltage to maintain output voltage regulation, depending on the load current and the output voltage level, can be calculated as:

$$V_{IN(min)} = V_{OUT(min)} + I_{OUT} (R_{DS(on)} + R_L) \quad (3)$$

where

$I_{OUT}$  is the output current,

$R_{DS(on)}$  is the  $R_{DS(on)}$  of the high-side FET and

$R_L$  is the DC resistance of the inductor used.

## Enable / Shutdown (EN)

When Enable (EN) is set High, the device starts operation.

Shutdown is forced if EN is pulled Low with a shutdown current of typically 1.5 $\mu$ A. During shutdown, the internal power MOSFETs as well as the entire control circuitry are turned off. The internal resistive divider pulls down the output voltage smoothly. If the EN pin is Low, an internal pull-down resistor of about 400k $\Omega$  is connected and keeps it Low, to avoid bouncing. To avoid ON/OFF oscillations, a minimum slew rate of about 50mV/s is recommended for the EN signal.

Connecting the EN pin to an appropriate output signal of another power rail provides sequencing of multiple power rails.

## Softstart

The internal soft start circuitry controls the output voltage slope during startup. This avoids excessive inrush current and ensures a controlled output voltage rise time. It also prevents unwanted voltage drops from high-impedance power sources or batteries. When EN is set to start device operation, the device starts switching after a delay of about 50 $\mu$ s and  $V_{OUT}$  rises with a slope of about 25mV/ $\mu$ s. See [Figure 29](#) and [Figure 30](#) for typical startup operation.

The TPS6216X can start into a pre-biased output. During monotonic pre-biased startup, the low-side MOSFET is not allowed to turn on until the device's internal ramp sets an output voltage above the pre-bias voltage.

## Current Limit And Short Circuit Protection

The TPS6216X devices are protected against heavy load and short circuit events. At heavy loads, the current limit determines the maximum output current. If the current limit is reached, the high-side FET will be turned off. Avoiding shoot through current, the low-side FET will be switched on to sink the inductor current. The high-side FET will turn on again, only if the current in the low-side FET has decreased below the low side current limit threshold.

The output current of the device is limited by the current limit (see [ELECTRICAL CHARACTERISTICS](#)). Due to internal propagation delay, the actual current can exceed the static current limit during that time. The dynamic current limit can be calculated as follows:

$$I_{peak(typ)} = I_{LIMF} + \frac{V_L}{L} \cdot t_{PD} \quad (4)$$

where

$I_{LIMF}$  is the static current limit, specified in the electrical characteristic table,

$L$  is the inductor value,

$V_L$  is the voltage across the inductor and

$t_{PD}$  is the internal propagation delay.



The dynamic high side switch peak current can be calculated as follows:

$$I_{peak(typ)} = I_{LIMF\_HS} + \frac{(V_{IN} - V_{OUT})}{L} \cdot 30ns \quad (5)$$

Care on the current limit has to be taken if the input voltage is high and very small inductances are used.

### Power Good (PG)

The TPS6216X has a built in power good (PG) function to indicate whether the output voltage has reached its appropriate level or not. The PG signal can be used for startup sequencing of multiple rails. The PG pin is an open-drain output that requires a pull-up resistor (to any voltage below 7V). It can sink 2mA of current and maintain its specified logic low level. It is high impedance when the device is turned off due to EN, UVLO or thermal shutdown.

### Under Voltage Lockout (UVLO)

If the input voltage drops, the under voltage lockout prevents misoperation of the device by switching off both the power FETs. The under voltage lockout threshold is set typically to 2.7V. The device is fully operational for voltages above the UVLO threshold and turns off if the input voltage trips the threshold. The converter starts operation again once the input voltage exceeds the threshold by a hysteresis of typically 180mV.

### Thermal Shutdown

The junction temperature (Tj) of the device is monitored by an internal temperature sensor. If Tj exceeds 160°C (typ), the device goes into thermal shut down. Both the high-side and low-side power FETs are turned off and PG goes high impedance. When Tj decreases below the hysteresis amount, the converter resumes normal operation, beginning with Soft Start. To avoid unstable conditions, a hysteresis of typically 20°C is implemented on the thermal shut down temperature.



## APPLICATION INFORMATION

The following information is intended to be a guideline through the individual power supply design process.

### Programming The Output Voltage

While the output voltage of the TPS62160 is adjustable, the TPS62161/2/3 are programmed to fixed output voltages. For fixed output versions, the FB pin is pulled down internally and may be left floating. It is recommended to connect it to AGND to improve thermal resistance. The adjustable version can be programmed for output voltages from 0.9V to 6V by using a resistive divider from VOUT to AGND. The voltage at the FB pin is regulated to 800mV. The value of the output voltage is set by the selection of the resistive divider from [Equation 6](#). It is recommended to choose resistor values which allow a cross current of at least 2µA, meaning the value of R2 should not exceed 400kΩ. Lower resistor values are recommended for highest accuracy and most robust design. For applications requiring lowest current consumption, the use of fixed output voltage versions is recommended.

$$R_1 = R_2 \left( \frac{V_{OUT}}{V_{REF}} - 1 \right) \quad (6)$$

In case the FB pin gets opened, the device clamps the output voltage at the VOS pin to about 7.4V.

### External Component Selection

The external components have to fulfill the needs of the application, but also the stability criteria of the devices control loop. The TPS6216X is optimized to work within a range of external components. The LC output filters inductance and capacitance have to be considered together, creating a double pole, responsible for the corner frequency of the converter (see [Output Filter And Loop Stability](#) section). [Table 1](#) can be used to simplify the output filter component selection.

**Table 1. Recommended LC Output Filter Combinations<sup>(1)</sup>**

	4.7µF	10µF	22µF	47µF	100µF	200µF	400µF
1µH							
2.2µH		√	√ <sup>(2)</sup>	√	√	√	
3.3µH		√	√	√	√		
4.7µH							

(1) The values in the table are nominal values. Variations of typically ±20% due to tolerance, saturation and DC bias are assumed.

(2) This LC combination is the standard value and recommended for most applications.

More detailed information on further LC combinations can be found in [SLVA463](#).

### Inductor Selection

The inductor selection is affected by several effects like inductor ripple current, output ripple voltage, PWM-to-PSM transition point and efficiency. In addition, the inductor selected has to be rated for appropriate saturation current and DC resistance (DCR). [Equation 7](#) and [Equation 8](#) calculate the maximum inductor current under static load conditions.

$$I_{L(max)} = I_{OUT(max)} + \frac{\Delta I_{L(max)}}{2} \quad (7)$$

$$\Delta I_{L(max)} = V_{OUT} \cdot \left( \frac{1 - \frac{V_{OUT}}{V_{IN(max)}}}{L_{(min)} \cdot f_{SW}} \right) \quad (8)$$

where

- $I_L(\text{max})$  is the maximum inductor current,
- $\Delta I_L$  is the Peak to Peak Inductor Ripple Current,
- $L(\text{min})$  is the minimum effective inductor value and
- $f_{\text{SW}}$  is the actual PWM Switching Frequency.

Calculating the maximum inductor current using the actual operating conditions gives the minimum saturation current of the inductor needed. A margin of about 20% is recommended to add. A larger inductor value is also useful to get lower ripple current, but increases the transient response time and size as well. The following inductors have been used with the TPS6216X and are recommended for use:

**Table 2. List of Inductors**

Type	Inductance [ $\mu\text{H}$ ]	Current [A] <sup>(1)</sup>	Dimensions [L x B x H] mm	MANUFACTURER
VLF3012ST-2R2M1R4	2.2 $\mu\text{H}$ , $\pm 20\%$	1.9A	3.0 x 2.8 x 1.2	TDK
VLF302512MT-2R2M	2.2 $\mu\text{H}$ , $\pm 20\%$	1.9A	3.0 x 2.5 x 1.2	TDK
VLS252012T-2R2M1R3	2.2 $\mu\text{H}$ , $\pm 20\%$	1.3A	2.5 x 2.0 x 1.2	TDK
XFL3012-222MEC	2.2 $\mu\text{H}$ , $\pm 20\%$	1.9A	3.0 x 3.0 x 1.2	Coilcraft
XFL3012-332MEC	3.3 $\mu\text{H}$ , $\pm 20\%$	1.6A	3.0 x 3.0 x 1.2	Coilcraft
LPS3015-332ML_	3.3 $\mu\text{H}$ , $\pm 20\%$	1.4A	3.0 x 3.0 x 1.4	Coilcraft
NR3015T-2R2M	2.2 $\mu\text{H}$ , $\pm 20\%$	1.5A	3.0 x 3.0 x 1.5	Taiyo Yuden
744025003	3.3 $\mu\text{H}$ , $\pm 20\%$	1.5A	2.8 x 2.8 x 2.8	Wuerth
PSI25201B-2R2MS	2.2 $\mu\text{H}$ , $\pm 20\%$	1.3A	2.0 x 2.5 x 1.2	Cyntec

(1)  $I_{\text{RMS}}$  at 40°C rise or  $I_{\text{SAT}}$  at 30% drop.

The TPS6216X can be run with an inductor as low as 2.2 $\mu\text{H}$ . However, for applications with low input voltages, 3.3 $\mu\text{H}$  is recommended, to allow the full output current. The inductor value also determines the load current at which Power Save Mode is entered:

$$I_{\text{load(PSM)}} = \frac{1}{2} \Delta I_L \tag{9}$$

Using [Equation 8](#), this current level can be adjusted by changing the inductor value.

## Capacitor Selection

### Output Capacitor

The recommended value for the output capacitor is 22 $\mu\text{F}$ . The architecture of the TPS6216X allows the use of tiny ceramic output capacitors with low equivalent series resistance (ESR). These capacitors provide low output voltage ripple and are recommended. To keep its low resistance up to high frequencies and to get narrow capacitance variation with temperature, it's recommended to use X7R or X5R dielectric. Using a higher value can have some advantages like smaller voltage ripple and a tighter DC output accuracy in Power Save Mode (see [SLVA463](#)).

Note: In power save mode, the output voltage ripple depends on the output capacitance, its ESR and the peak inductor current. Using ceramic capacitors provides small ESR and low ripple.

### Input Capacitor

For most applications, 10 $\mu\text{F}$  will be sufficient and is recommended, though a larger value reduces input current ripple further. The input capacitor buffers the input voltage for transient events and also decouples the converter from the supply. A low ESR multilayer ceramic capacitor is recommended for best filtering and should be placed between VIN and GND as close as possible to those pins.

### NOTE

**DC Bias effect:** High capacitance ceramic capacitors have a DC Bias effect, which will have a strong influence on the final effective capacitance. Therefore the right capacitor value has to be chosen carefully. Package size and voltage rating in combination with dielectric material are responsible for differences between the rated capacitor value and the effective capacitance.

## Output Filter And Loop Stability

The devices of the TPS6216X family are internally compensated to be stable with L-C filter combinations corresponding to a corner frequency to be calculated with [Equation 10](#):

$$f_{LC} = \frac{1}{2\pi\sqrt{L \cdot C}} \quad (10)$$

Proven nominal values for inductance and ceramic capacitance are given in [Table 1](#) and are recommended for use. Different values may work, but care has to be taken on the loop stability which will be affected. More information including a detailed L-C stability matrix can be found in [SLVA463](#).

The TPS6216X devices, both fixed and adjustable versions, include an internal 25pF feedforward capacitor, connected between the VOS and FB pins. This capacitor impacts the frequency behavior and sets a pole and zero in the control loop with the resistors of the feedback divider, per [Equation 11](#) and [Equation 12](#):

$$f_{zero} = \frac{1}{2\pi \cdot R_1 \cdot 25 pF} \quad (11)$$

$$f_{pole} = \frac{1}{2\pi \cdot 25 pF} \cdot \left( \frac{1}{R_1} + \frac{1}{R_2} \right) \quad (12)$$

Though the TPS6216X devices are stable without the pole and zero being in a particular location, adjusting their location to the specific needs of the application can provide better performance in Power Save mode and/or improved transient response. An external feedforward capacitor can also be added. A more detailed discussion on the optimization for stability vs. transient response can be found in [SLVA289](#) and [SLVA466](#).

If using ceramic capacitors, the DC bias effect has to be considered. The DC bias effect results in a drop in effective capacitance as the voltage across the capacitor increases (see [DC Bias effect](#) NOTE in Capacitor Selection section).

## Layout Considerations

A proper layout is critical for the operation of a switched mode power supply, even more at high switching frequencies. Therefore the PCB layout of the TPS6216X demands careful attention to ensure operation and to get the performance specified. A poor layout can lead to issues like poor regulation (both line and load), stability and accuracy weaknesses, increased EMI radiation and noise sensitivity.

Provide low inductive and resistive paths to ground for loops with high di/dt. Therefore paths conducting the switched load current should be as short and wide as possible. Provide low capacitive paths (with respect to all other nodes) for wires with high dv/dt. Therefore the input and output capacitance should be placed as close as possible to the IC pins and parallel wiring over long distances as well as narrow traces should be avoided. Loops which conduct an alternating current should outline an area as small as possible, as this area is proportional to the energy radiated.

Also sensitive nodes like FB and VOS should be connected with short wires, not nearby high dv/dt signals (e.g. SW). As they carry information about the output voltage, they should be connected as close as possible to the actual output voltage (at the output capacitor). Signals not assigned to power transmission (e.g. feedback divider) should refer to the signal ground (AGND) and always be separated from the power ground (PGND).

In summary, the input capacitor should be placed as close as possible to the VIN and PGND pin of the IC. This connections should be done with wide and short traces. The output capacitor should be placed such that its ground is as close as possible to the IC's PGND pins - avoiding additional voltage drop in traces. This connection should also be made short and wide. The inductor should be placed close to the SW pin and connect directly to the output capacitor - minimizing the loop area between the SW pin, inductor, output capacitor and PGND pin. The feedback resistors,  $R_1$  and  $R_2$ , should be placed close to the IC and connect directly to the AGND and FB pins. Those connections (including VOUT) to the resistors and even more to the VOS pin should stay away from noise sources, such as the inductor. The VOS pin should connect in the shortest way to VOUT at the output capacitor, while the VOUT connection to the feedback divider can connect at the load.

A single point grounding scheme should be implemented with all grounds (AGND, PGND and the thermal pad) connecting at the IC's exposed thermal pad. See [Figure 33](#) for the recommended layout of the TPS6216X. More detailed information can be found in the EVM Users Guide, [SLVU483](#).

The Exposed Thermal Pad must be soldered to the circuit board for mechanical reliability and to achieve appropriate power dissipation. Although the Exposed Thermal Pad can be connected to a floating circuit board trace, the device will have better thermal performance if it is connected to a larger ground plane. The Exposed Thermal Pad is electrically connected to AGND.

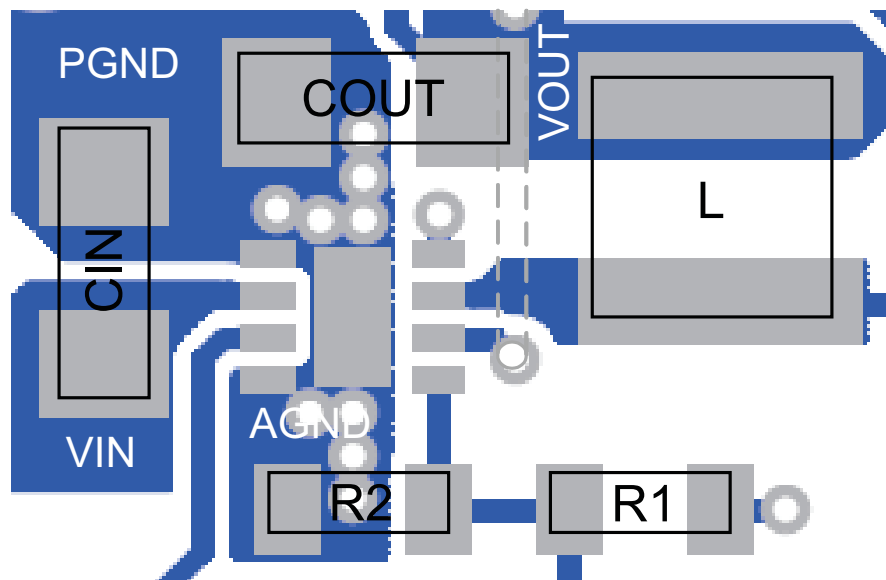

Figure 33. Layout Example

## THERMAL INFORMATION

Implementation of integrated circuits in low-profile and fine-pitch surface-mount packages typically requires special attention to power dissipation. Many system-dependent issues such as thermal coupling, airflow, added heat sinks and convection surfaces, and the presence of other heat-generating components affect the power-dissipation limits of a given component.

Three basic approaches for enhancing thermal performance are listed below:

- Improving the power dissipation capability of the PCB design
- Improving the thermal coupling of the component to the PCB by soldering the Exposed Thermal Pad
- Introducing airflow in the system

For more details on how to use the thermal parameters, see the application notes: Thermal Characteristics Application Note ([SZZA017](#)), and ([SPRA953](#)).

The TPS6216X is designed for a maximum operating junction temperature ( $T_j$ ) of 125°C. Therefore the maximum output power is limited by the power losses that can be dissipated over the actual thermal resistance, given by the package and the surrounding PCB structures. If the thermal resistance of the package is given, the size of the surrounding copper area and a proper thermal connection of the IC can reduce the thermal resistance. To get an improved thermal behavior, it's recommended to use top layer metal to connect the device with wide and thick metal lines. Internal ground layers can connect to vias directly under the IC for improved thermal performance.

If short circuit or overload conditions are present, the device is protected by limiting internal power dissipation.

## Typical Applications

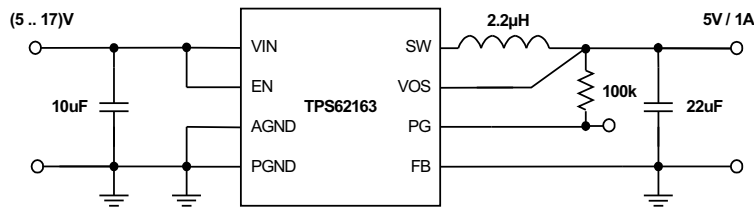

Figure 34. 5V/1A Power Supply

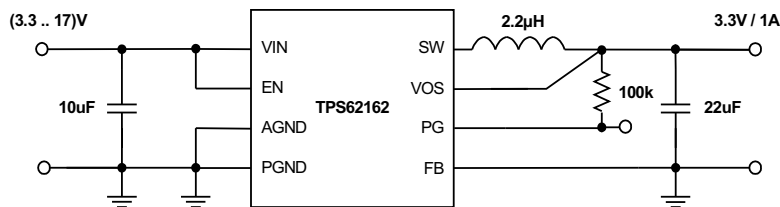

Figure 35. 3.3V/1A Power Supply

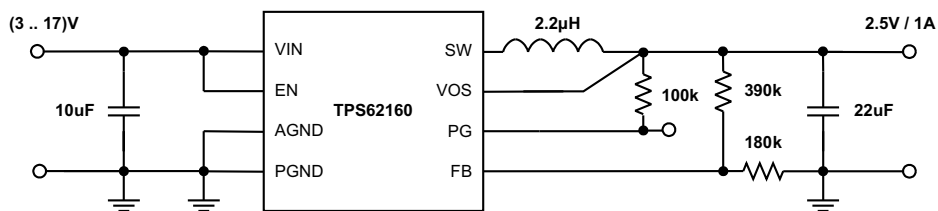

Figure 36. 2.5V/1A Power Supply

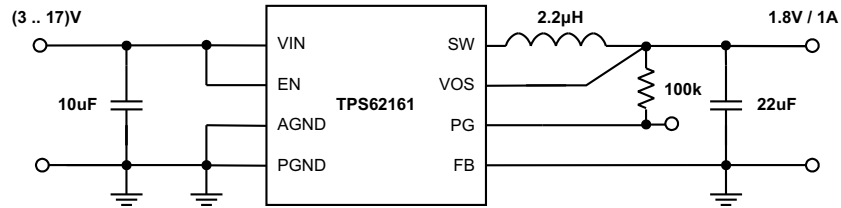

Figure 37. 1.8V/1A Power Supply

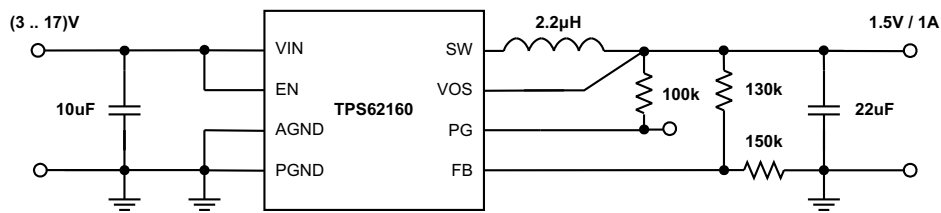

Figure 38. 1.5V/1A Power Supply

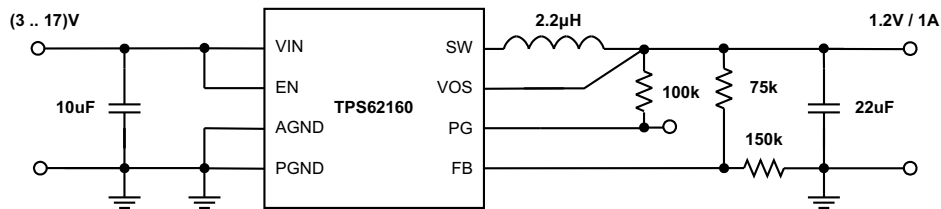

Figure 39. 1.2V/1A Power Supply

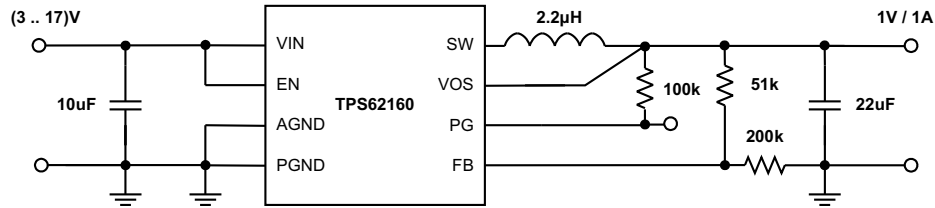

Figure 40. 1V/1A Power Supply

### Application Example As Inverting Power Supply

The TPS62160 can be used as inverting power supply by rearranging external circuitry as shown in Figure 41. As the former GND node now represents a voltage level below system ground, the voltage difference between  $V_{IN}$  and  $V_{OUT}$  has to be limited for operation to the maximum supply voltage of 17V (see Equation 13).

$$V_{IN} + V_{OUT} \leq V_{IN\ max}$$

(13)

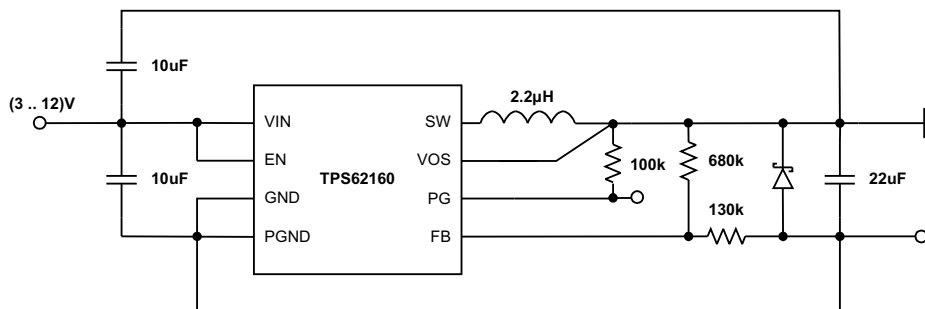

Figure 41. -5V Inverting Power Supply

The transfer function of the inverting power supply configuration differs from the buck mode transfer function, incorporating a Right Half Plane Zero additionally. The loop stability has to be adapted and an output capacitance of at least 22uF is recommended. A detailed design example is given in SLVA469.



## REVISION HISTORY

<b>Changes from Original (November 2011) to Revision A</b>	<b>Page</b>
• Changed data sheet from mixed status to production data .....	1
• Added MSOP-8 package to FEATURES .....	1
• Added 8-pin MSOP package to DESCRIPTION .....	1
• Deleted product preview from TPS62160 DGK package in ORDERING INFORMATION .....	2
• Added DGK package to THERMAL INFORMATION .....	2
• Added DGK package pinout .....	4
• Changed <a href="#">Table 1</a> .....	17
<b>Changes from Revision A (March 2012) to Revision B</b>	<b>Page</b>
• Added note to Terminal Functions .....	4
• Changed 50mV/s to 50mV/μs in Enable / Shutdown (EN) section .....	15
• Added Application Example As Inverting Power Supply section .....	24
• Changed <a href="#">Equation 13</a> .....	24
• Added diode to <a href="#">Figure 41</a> .....	24
<b>Changes from Revision B (August 2013) to Revision C</b>	<b>Page</b>
• Changed 50mV/μs to 50mV/s in Enable / Shutdown (EN) section .....	15

**PACKAGING INFORMATION**

Orderable Device	Status (1)	Package Type	Package Drawing	Pins	Package Qty	Eco Plan (2)	Lead/Ball Finish	MSL Peak Temp (3)	Op Temp (°C)	Device Marking (4/5)	Samples
TPS62160DGKR	ACTIVE	VSSOP	DGK	8	2500	Green (RoHS & no Sb/Br)	CU NIPDAUAG	Level-1-260C-UNLIM	-40 to 85	62160	<a href="#">Samples</a>
TPS62160DGKT	ACTIVE	VSSOP	DGK	8	250	Green (RoHS & no Sb/Br)	CU NIPDAUAG	Level-1-260C-UNLIM	-40 to 85	62160	<a href="#">Samples</a>
TPS62160DSGR	ACTIVE	WSO	DSG	8	3000	Green (RoHS & no Sb/Br)	CU NIPDAU	Level-2-260C-1 YEAR	-40 to 85	QTV	<a href="#">Samples</a>
TPS62160DSGT	ACTIVE	WSO	DSG	8	250	Green (RoHS & no Sb/Br)	CU NIPDAU	Level-2-260C-1 YEAR	-40 to 85	QTV	<a href="#">Samples</a>
TPS62161DSGR	ACTIVE	WSO	DSG	8	3000	Green (RoHS & no Sb/Br)	CU NIPDAU	Level-2-260C-1 YEAR	-40 to 85	QUB	<a href="#">Samples</a>
TPS62161DSGT	ACTIVE	WSO	DSG	8	250	Green (RoHS & no Sb/Br)	CU NIPDAU	Level-2-260C-1 YEAR	-40 to 85	QUB	<a href="#">Samples</a>
TPS62162DSGR	ACTIVE	WSO	DSG	8	3000	Green (RoHS & no Sb/Br)	CU NIPDAU	Level-2-260C-1 YEAR	-40 to 85	QUC	<a href="#">Samples</a>
TPS62162DSGT	ACTIVE	WSO	DSG	8	250	Green (RoHS & no Sb/Br)	CU NIPDAU	Level-2-260C-1 YEAR	-40 to 85	QUC	<a href="#">Samples</a>
TPS62163DSGR	ACTIVE	WSO	DSG	8	3000	Green (RoHS & no Sb/Br)	CU NIPDAU	Level-2-260C-1 YEAR	-40 to 85	QUD	<a href="#">Samples</a>
TPS62163DSGT	ACTIVE	WSO	DSG	8	250	Green (RoHS & no Sb/Br)	CU NIPDAU	Level-2-260C-1 YEAR	-40 to 85	QUD	<a href="#">Samples</a>

(1) The marketing status values are defined as follows:

**ACTIVE:** Product device recommended for new designs.

**LIFEBUY:** TI has announced that the device will be discontinued, and a lifetime-buy period is in effect.

**NRND:** Not recommended for new designs. Device is in production to support existing customers, but TI does not recommend using this part in a new design.

**PREVIEW:** Device has been announced but is not in production. Samples may or may not be available.

**OBSOLETE:** TI has discontinued the production of the device.

(2) Eco Plan - The planned eco-friendly classification: Pb-Free (RoHS), Pb-Free (RoHS Exempt), or Green (RoHS & no Sb/Br) - please check <http://www.ti.com/productcontent> for the latest availability information and additional product content details.

**TBD:** The Pb-Free/Green conversion plan has not been defined.

**Pb-Free (RoHS):** TI's terms "Lead-Free" or "Pb-Free" mean semiconductor products that are compatible with the current RoHS requirements for all 6 substances, including the requirement that lead not exceed 0.1% by weight in homogeneous materials. Where designed to be soldered at high temperatures, TI Pb-Free products are suitable for use in specified lead-free processes.

**Pb-Free (RoHS Exempt):** This component has a RoHS exemption for either 1) lead-based flip-chip solder bumps used between the die and package, or 2) lead-based die adhesive used between the die and leadframe. The component is otherwise considered Pb-Free (RoHS compatible) as defined above.

**Green (RoHS & no Sb/Br):** TI defines "Green" to mean Pb-Free (RoHS compatible), and free of Bromine (Br) and Antimony (Sb) based flame retardants (Br or Sb do not exceed 0.1% by weight in homogeneous material)

(3) MSL, Peak Temp. -- The Moisture Sensitivity Level rating according to the JEDEC industry standard classifications, and peak solder temperature.

(4) There may be additional marking, which relates to the logo, the lot trace code information, or the environmental category on the device.

(5) Multiple Device Markings will be inside parentheses. Only one Device Marking contained in parentheses and separated by a "~" will appear on a device. If a line is indented then it is a continuation of the previous line and the two combined represent the entire Device Marking for that device.

**Important Information and Disclaimer:**The information provided on this page represents TI's knowledge and belief as of the date that it is provided. TI bases its knowledge and belief on information provided by third parties, and makes no representation or warranty as to the accuracy of such information. Efforts are underway to better integrate information from third parties. TI has taken and continues to take reasonable steps to provide representative and accurate information but may not have conducted destructive testing or chemical analysis on incoming materials and chemicals. TI and TI suppliers consider certain information to be proprietary, and thus CAS numbers and other limited information may not be available for release.

In no event shall TI's liability arising out of such information exceed the total purchase price of the TI part(s) at issue in this document sold by TI to Customer on an annual basis.

## TAPE AND REEL INFORMATION



### QUADRANT ASSIGNMENTS FOR PIN 1 ORIENTATION IN TAPE



\*All dimensions are nominal

Device	Package Type	Package Drawing	Pins	SPQ	Reel Diameter (mm)	Reel Width W1 (mm)	A0 (mm)	B0 (mm)	K0 (mm)	P1 (mm)	W (mm)	Pin1 Quadrant
TPS62160DGKR	VSSOP	DGK	8	2500	330.0	12.4	5.3	3.4	1.4	8.0	12.0	Q1
TPS62160DGKT	VSSOP	DGK	8	250	180.0	12.4	5.3	3.4	1.4	8.0	12.0	Q1
TPS62160DSGR	WSOP	DSG	8	3000	180.0	8.4	2.3	2.3	1.15	4.0	8.0	Q2
TPS62160DSGT	WSOP	DSG	8	250	180.0	8.4	2.3	2.3	1.15	4.0	8.0	Q2
TPS62161DSGR	WSOP	DSG	8	3000	180.0	8.4	2.3	2.3	1.15	4.0	8.0	Q2
TPS62161DSGT	WSOP	DSG	8	250	180.0	8.4	2.3	2.3	1.15	4.0	8.0	Q2
TPS62162DSGR	WSOP	DSG	8	3000	180.0	8.4	2.3	2.3	1.15	4.0	8.0	Q2
TPS62162DSGT	WSOP	DSG	8	250	180.0	8.4	2.3	2.3	1.15	4.0	8.0	Q2
TPS62163DSGR	WSOP	DSG	8	3000	180.0	8.4	2.3	2.3	1.15	4.0	8.0	Q2
TPS62163DSGT	WSOP	DSG	8	250	180.0	8.4	2.3	2.3	1.15	4.0	8.0	Q2

**TAPE AND REEL BOX DIMENSIONS**

\*All dimensions are nominal

Device	Package Type	Package Drawing	Pins	SPQ	Length (mm)	Width (mm)	Height (mm)
TPS62160DGKR	VSSOP	DGK	8	2500	367.0	367.0	35.0
TPS62160DGKT	VSSOP	DGK	8	250	210.0	185.0	35.0
TPS62160DSGR	WSON	DSG	8	3000	210.0	185.0	35.0
TPS62160DSGT	WSON	DSG	8	250	210.0	185.0	35.0
TPS62161DSGR	WSON	DSG	8	3000	210.0	185.0	35.0
TPS62161DSGT	WSON	DSG	8	250	210.0	185.0	35.0
TPS62162DSGR	WSON	DSG	8	3000	210.0	185.0	35.0
TPS62162DSGT	WSON	DSG	8	250	210.0	185.0	35.0
TPS62163DSGR	WSON	DSG	8	3000	210.0	185.0	35.0
TPS62163DSGT	WSON	DSG	8	250	210.0	185.0	35.0

DGK (S-PDSO-G8)

PLASTIC SMALL-OUTLINE PACKAGE



4073329/E 05/06

- NOTES:
- A. All linear dimensions are in millimeters.
  - B. This drawing is subject to change without notice.
  - C. Body length does not include mold flash, protrusions, or gate burrs. Mold flash, protrusions, or gate burrs shall not exceed 0.15 per end.
  - D. Body width does not include interlead flash. Interlead flash shall not exceed 0.50 per side.
  - E. Falls within JEDEC MO-187 variation AA, except interlead flash.

DSG (S-PWSON-N8)

PLASTIC SMALL OUTLINE NO-LEAD



4208210/B 10/10

- NOTES:
- A. All linear dimensions are in millimeters. Dimensioning and tolerancing per ASME Y14.5M-1994.
  - B. This drawing is subject to change without notice.
  - C. Quad Flatpack, No-Leads (QFN) package configuration.
  -  The package thermal pad must be soldered to the board for thermal and mechanical performance. See the Product Data Sheet for details regarding the exposed thermal pad dimensions.
  - E. Falls within JEDEC MO-229.

## THERMAL PAD MECHANICAL DATA

DSG (S-PWSON-N8)

PLASTIC SMALL OUTLINE NO-LEAD

### THERMAL INFORMATION

This package incorporates an exposed thermal pad that is designed to be attached directly to an external heatsink. The thermal pad must be soldered directly to the printed circuit board (PCB). After soldering, the PCB can be used as a heatsink. In addition, through the use of thermal vias, the thermal pad can be attached directly to the appropriate copper plane shown in the electrical schematic for the device, or alternatively, can be attached to a special heatsink structure designed into the PCB. This design optimizes the heat transfer from the integrated circuit (IC).

For information on the Quad Flatpack No-Lead (QFN) package and its advantages, refer to Application Report, QFN/SON PCB Attachment, Texas Instruments Literature No. SLUA271. This document is available at [www.ti.com](http://www.ti.com).

The exposed thermal pad dimensions for this package are shown in the following illustration.

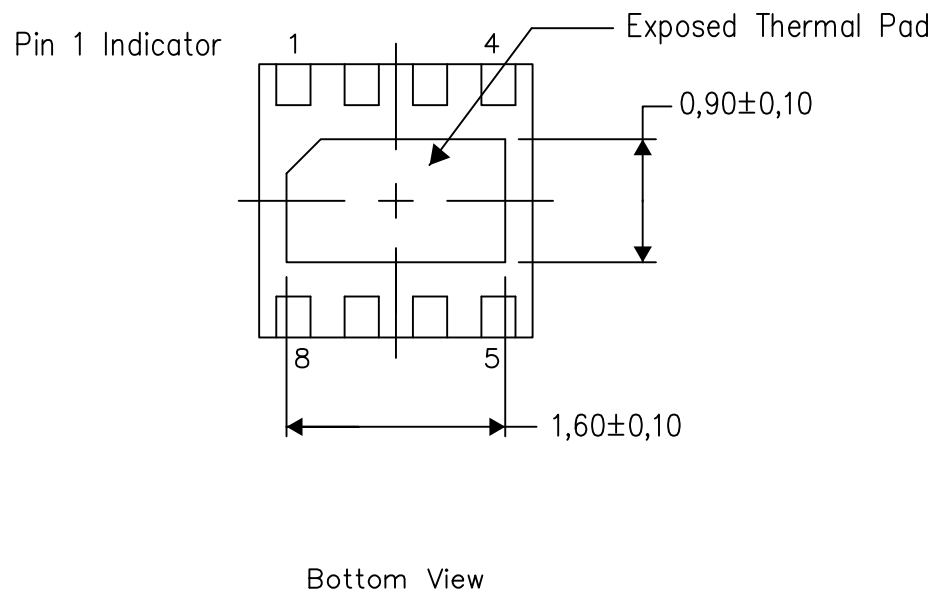

Exposed Thermal Pad Dimensions

4208347/G 08/13

NOTE: All linear dimensions are in millimeters



DSG (S-PWSON-N8)

PLASTIC SMALL OUTLINE NO-LEAD

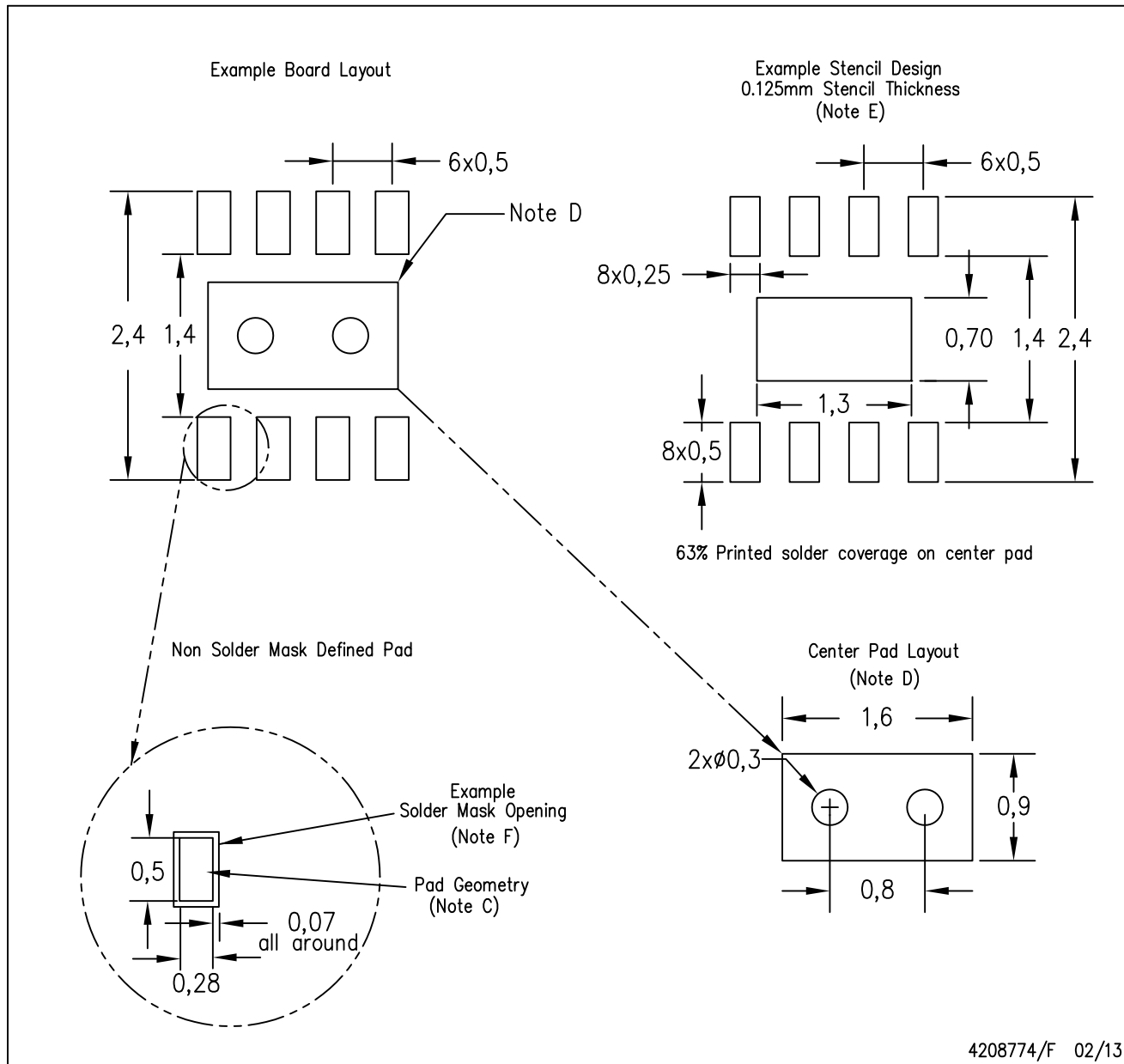

4208774/F 02/13

- NOTES:
- A. All linear dimensions are in millimeters.
  - B. This drawing is subject to change without notice.
  - C. Publication IPC-7351 is recommended for alternate designs.
  - D. This package is designed to be soldered to a thermal pad on the board. Refer to Application Note, QFN/SON PCB Attachment, Texas Instruments Literature No. SLUA271, and also the Product Data Sheets for specific thermal information, via requirements, and recommended board layout. These documents are available at [www.ti.com](http://www.ti.com) <<http://www.ti.com>>.
  - E. Laser cutting apertures with trapezoidal walls and also rounding corners will offer better paste release. Customers should contact their board assembly site for stencil design recommendations. Refer to IPC 7525 for stencil design considerations.
  - F. Customers should contact their board fabrication site for solder mask tolerances.

## IMPORTANT NOTICE

Texas Instruments Incorporated and its subsidiaries (TI) reserve the right to make corrections, enhancements, improvements and other changes to its semiconductor products and services per JESD46, latest issue, and to discontinue any product or service per JESD48, latest issue. Buyers should obtain the latest relevant information before placing orders and should verify that such information is current and complete. All semiconductor products (also referred to herein as "components") are sold subject to TI's terms and conditions of sale supplied at the time of order acknowledgment.

TI warrants performance of its components to the specifications applicable at the time of sale, in accordance with the warranty in TI's terms and conditions of sale of semiconductor products. Testing and other quality control techniques are used to the extent TI deems necessary to support this warranty. Except where mandated by applicable law, testing of all parameters of each component is not necessarily performed.

TI assumes no liability for applications assistance or the design of Buyers' products. Buyers are responsible for their products and applications using TI components. To minimize the risks associated with Buyers' products and applications, Buyers should provide adequate design and operating safeguards.

TI does not warrant or represent that any license, either express or implied, is granted under any patent right, copyright, mask work right, or other intellectual property right relating to any combination, machine, or process in which TI components or services are used. Information published by TI regarding third-party products or services does not constitute a license to use such products or services or a warranty or endorsement thereof. Use of such information may require a license from a third party under the patents or other intellectual property of the third party, or a license from TI under the patents or other intellectual property of TI.

Reproduction of significant portions of TI information in TI data books or data sheets is permissible only if reproduction is without alteration and is accompanied by all associated warranties, conditions, limitations, and notices. TI is not responsible or liable for such altered documentation. Information of third parties may be subject to additional restrictions.

Resale of TI components or services with statements different from or beyond the parameters stated by TI for that component or service voids all express and any implied warranties for the associated TI component or service and is an unfair and deceptive business practice. TI is not responsible or liable for any such statements.

Buyer acknowledges and agrees that it is solely responsible for compliance with all legal, regulatory and safety-related requirements concerning its products, and any use of TI components in its applications, notwithstanding any applications-related information or support that may be provided by TI. Buyer represents and agrees that it has all the necessary expertise to create and implement safeguards which anticipate dangerous consequences of failures, monitor failures and their consequences, lessen the likelihood of failures that might cause harm and take appropriate remedial actions. Buyer will fully indemnify TI and its representatives against any damages arising out of the use of any TI components in safety-critical applications.

In some cases, TI components may be promoted specifically to facilitate safety-related applications. With such components, TI's goal is to help enable customers to design and create their own end-product solutions that meet applicable functional safety standards and requirements. Nonetheless, such components are subject to these terms.

No TI components are authorized for use in FDA Class III (or similar life-critical medical equipment) unless authorized officers of the parties have executed a special agreement specifically governing such use.

Only those TI components which TI has specifically designated as military grade or "enhanced plastic" are designed and intended for use in military/aerospace applications or environments. Buyer acknowledges and agrees that any military or aerospace use of TI components which have **not** been so designated is solely at the Buyer's risk, and that Buyer is solely responsible for compliance with all legal and regulatory requirements in connection with such use.

TI has specifically designated certain components as meeting ISO/TS16949 requirements, mainly for automotive use. In any case of use of non-designated products, TI will not be responsible for any failure to meet ISO/TS16949.

### Products

Audio	<a href="http://www.ti.com/audio">www.ti.com/audio</a>
Amplifiers	<a href="http://amplifier.ti.com">amplifier.ti.com</a>
Data Converters	<a href="http://dataconverter.ti.com">dataconverter.ti.com</a>
DLP® Products	<a href="http://www.dlp.com">www.dlp.com</a>
DSP	<a href="http://dsp.ti.com">dsp.ti.com</a>
Clocks and Timers	<a href="http://www.ti.com/clocks">www.ti.com/clocks</a>
Interface	<a href="http://interface.ti.com">interface.ti.com</a>
Logic	<a href="http://logic.ti.com">logic.ti.com</a>
Power Mgmt	<a href="http://power.ti.com">power.ti.com</a>
Microcontrollers	<a href="http://microcontroller.ti.com">microcontroller.ti.com</a>
RFID	<a href="http://www.ti-rfid.com">www.ti-rfid.com</a>
OMAP Applications Processors	<a href="http://www.ti.com/omap">www.ti.com/omap</a>
Wireless Connectivity	<a href="http://www.ti.com/wirelessconnectivity">www.ti.com/wirelessconnectivity</a>

### Applications

Automotive and Transportation	<a href="http://www.ti.com/automotive">www.ti.com/automotive</a>
Communications and Telecom	<a href="http://www.ti.com/communications">www.ti.com/communications</a>
Computers and Peripherals	<a href="http://www.ti.com/computers">www.ti.com/computers</a>
Consumer Electronics	<a href="http://www.ti.com/consumer-apps">www.ti.com/consumer-apps</a>
Energy and Lighting	<a href="http://www.ti.com/energy">www.ti.com/energy</a>
Industrial	<a href="http://www.ti.com/industrial">www.ti.com/industrial</a>
Medical	<a href="http://www.ti.com/medical">www.ti.com/medical</a>
Security	<a href="http://www.ti.com/security">www.ti.com/security</a>
Space, Avionics and Defense	<a href="http://www.ti.com/space-avionics-defense">www.ti.com/space-avionics-defense</a>
Video and Imaging	<a href="http://www.ti.com/video">www.ti.com/video</a>

### TI E2E Community

[e2e.ti.com](http://e2e.ti.com)