

REF50xx

Low-Noise, Very Low Drift, Precision Voltage Reference

1 Features

- Low Temperature Drift:
 - High-Grade: 3 ppm/°C (Max)
 - Standard-Grade: 8 ppm/°C (Max)
- High Accuracy:
 - High-Grade: 0.05% (Max)
 - Standard-Grade: 0.1% (Max)
- Low Noise: 3 $\mu\text{V}_{\text{PP}}/\text{V}$
- Excellent Long-Term Stability:
 - 45 ppm/1000 hr (Typ) after 1000 Hours
- High-Output Current: ± 10 mA
- Temperature Range: -40°C to 125°C

2 Applications

- Precision Data Acquisition Systems
- ATE Equipment
- Industrial Process Controls
- Medical Instrumentation
- Pressure and Temperature Transmitters
- Seismic monitoring systems

3 Description

The REF50xx is a family of low-noise, low-drift, very high precision voltage references. These references are capable of both sinking and sourcing current, and have excellent line and load regulation.

Excellent temperature drift (3 ppm/°C) and high accuracy (0.05%) are achieved using proprietary design techniques. These features, combined with very low noise, make the REF50xx family ideal for use in high-precision data acquisition systems.

Each reference voltage is available in both high grade (REF50xxIDGK and REF50xxID) and standard grade (REF50xxAIDGK and REF50xxAID). The reference voltages are offered in 8-pin VSSOP and SOIC packages, and are specified from -40°C to 125°C .

Device Information⁽¹⁾

PART NUMBER	PACKAGE	BODY SIZE (NOM)
REF50xx	SOIC (8)	4.90 mm x 3.91 mm
	VSSOP (8)	3.00 mm x 3.00 mm

(1) For all available packages, see the orderable addendum at the end of the data sheet.

Simplified Schematic

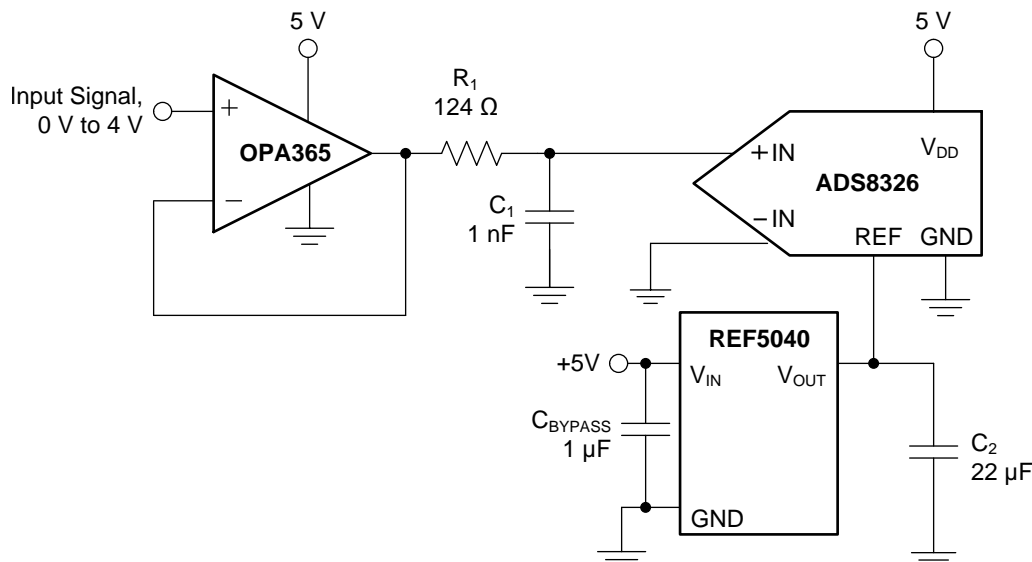

Copyright © 2016, Texas Instruments Incorporated



Table of Contents

1 Features	1	9.3 Feature Description	16
2 Applications	1	9.4 Device Functional Modes	18
3 Description	1	10 Applications and Implementation	19
4 Revision History	2	10.1 Application Information	19
5 Device Comparison Table	4	10.2 Typical Applications	19
6 Pin Configuration and Functions	4	11 Power Supply Recommendations	21
7 Specifications	5	12 Layout	21
7.1 Absolute Maximum Ratings	5	12.1 Layout Guidelines	21
7.2 ESD Ratings	5	12.2 Layout Example	21
7.3 Recommended Operating Conditions	5	12.3 Power Dissipation	21
7.4 Thermal Information	5	13 Device and Documentation Support	22
7.5 Electrical Characteristics	6	13.1 Documentation Support	22
7.6 Typical Characteristics	8	13.2 Related Links	22
8 Parameter Measurement Information	13	13.3 Community Resources	22
8.1 Solder Heat Shift	13	13.4 Trademarks	22
9 Detailed Description	15	13.5 Electrostatic Discharge Caution	22
9.1 Overview	15	13.6 Glossary	22
9.2 Functional Block Diagram	15	14 Mechanical, Packaging, and Orderable Information	23

4 Revision History

NOTE: Page numbers for previous revisions may differ from page numbers in the current version.

Changes from Revision G (November 2015) to Revision H	Page
• Changed all (<i>Maximum</i>) to (<i>Max</i>) in <i>Features</i> section	1
• Changed <i>MSOP</i> to <i>VSSOP</i> and <i>SO</i> to <i>SOIC</i> throughout document	1
• Added TI Design	1
• Changed first <i>Applications</i> bullet	1
• Changed last paragraph of <i>Description</i> section	1
• Changed <i>Simplified Schematic</i>	1
• Changed device name in <i>Recommended Operating Conditions</i> table footnote	5
• Added <i>Output Voltage</i> and <i>Noise</i> sections to <i>Electrical Characteristics</i> table	6
• Changed third bullet in <i>Layout Guidelines</i> section	21

Changes from Revision F (December 2013) to Revision G	Page
• Added <i>ESD Ratings</i> table, <i>Feature Description</i> section, <i>Device Functional Modes</i> , <i>Application and Implementation</i> section, <i>Power Supply Recommendations</i> section, <i>Layout</i> section, <i>Device and Documentation Support</i> section, and <i>Mechanical, Packaging, and Orderable Information</i> section	1

Changes from Revision E (June 2010) to Revision F	Page
• Changed <i>Excellent Long-Term Stability</i> feature bullet	1
• Changed <i>Thermal Hysteresis</i> typical values	6
• Changed <i>Long-Term Stability</i> typical values	6
• Added note 3 to <i>Electrical Characteristics</i>	6
• Changed Figure 22	10
• Changed Figure 23	10
• Changed Figure 24	10
• Changed Figure 25	11
• Changed Figure 26	11
• Changed Figure 27	11

Changes from Revision D (April 2009) to Revision E	Page
• Updated <i>Features</i> list; added <i>Excellent Long-Term Stability</i> bullet	1
• Added <i>Thermal Hysteresis</i> parameters and specifications	6
• Added <i>Long-Term Stability</i> parameters and specifications	6
• Added Figure 22 through Figure 24	10
• Added Figure 25 through Figure 27	11
• Added <i>Thermal Hysteresis</i> section.....	16
• Revised <i>Noise Performance</i> section; added paragraph with links to applications articles	17

Changes from Revision C (December 2008) to Revision D	Page
• Removed all notes regarding MSOP-8 package status. MSOP-8 package released at time of document revision.....	1
• Changed <i>Storage Temperature Range</i> absolute minimum value from –55°C to –65°C.....	5
• Added <i>Load Regulation</i> test condition and <i>Over Temperature</i> specifications	6
• Added typical characteristic graph, <i>Quiescent Current vs Input Voltage</i> (Figure 10)	8

5 Device Comparison Table

MODEL	OUTPUT VOLTAGE
REF5020	2.048 V
REF5025	2.5 V
REF5030	3 V
REF5040	4.096 V
REF5045	4.5 V
REF5050	5 V
REF5010	10 V

6 Pin Configuration and Functions

D, DGK Packages
8-Pin SOIC, VSSOP
Top View

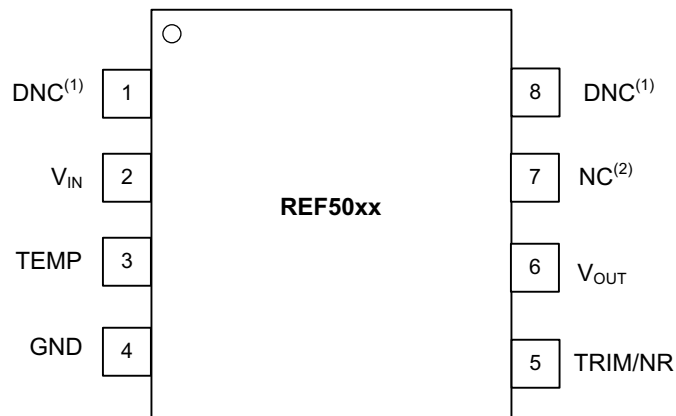

NOTES: (1) DNC = Do not connect.
(2) NC = No internal connection.

Pin Functions

PIN		DESCRIPTION
NAME	NO.	
DNC	1	Do not connect
VIN	2	Input supply voltage
TEMP	3	Temperature monitoring pin. Provides a temperature-dependent output voltage
GND	4	Ground
TRIM/NR	5	Output adjustment and noise reduction pin
VOUT	6	Reference voltage output
NC	7	No internal connection
DNC	8	Do not connect

7 Specifications

7.1 Absolute Maximum Ratings

over operating free-air temperature range (unless otherwise noted)⁽¹⁾

	MIN	MAX	UNIT
Input voltage	-0.2	18	V
Output short circuit	-30	30	mA
Operating temperature	-55	125	°C
Junction temperature (T _J max)		150	°C
Storage temperature, T _{stg}	-65	150	°C

(1) Stresses above these ratings may cause permanent damage. Exposure to absolute maximum conditions for extended periods may degrade device reliability. These are stress ratings only, and functional operation of the device at these or any other conditions beyond those specified is not implied.

7.2 ESD Ratings

		VALUE	UNIT
V _(ESD) Electrostatic discharge	Human body model (HBM), per ANSI/ESDA/JEDEC JS-001 ⁽¹⁾	±3000	V
	Charged device model (CDM), per JEDEC specification JESD22-C101 ⁽²⁾	±1000	

(1) JEDEC document JEP155 states that 500-V HBM allows safe manufacturing with a standard ESD control process.

(2) JEDEC document JEP157 states that 250-V CDM allows safe manufacturing with a standard ESD control process.

7.3 Recommended Operating Conditions

over operating free-air temperature range (unless otherwise noted)

	MIN	NOM	MAX	UNIT
V _{IN}	V _{OUT} + 0.2 V ⁽¹⁾		18	V
I _{OUT}	-10		10	mA

(1) Except for the REF5020, where V_{IN} (min) = 2.7 V.

7.4 Thermal Information

THERMAL METRIC ⁽¹⁾		REF50xx		UNIT
		D (SOIC)	DGK (VSSOP)	
		8 PINS	8 PINS	
R _{θJA}	Junction-to-ambient thermal resistance	115	160.9	°C/W
R _{θJC(top)}	Junction-to-case (top) thermal resistance	63.4	53.9	°C/W
R _{θJB}	Junction-to-board thermal resistance	57.1	82.3	°C/W
Ψ _{JT}	Junction-to-top characterization parameter	15.4	5.1	°C/W
Ψ _{JB}	Junction-to-board characterization parameter	56.2	80.7	°C/W
R _{θJC(bot)}	Junction-to-case (bottom) thermal resistance	N/A	N/A	°C/W

(1) For more information about traditional and new thermal metrics, see the *Semiconductor and IC Package Thermal Metrics* application report, [SPRA953](#).

7.5 Electrical Characteristics

At $T_A = 25^\circ\text{C}$, $I_{\text{LOAD}} = 0$, $C_L = 1\ \mu\text{F}$, and $V_{\text{IN}} = (V_{\text{OUT}} + 0.2\ \text{V})$ to 18 V, unless otherwise noted.

PARAMETER		TEST CONDITIONS	MIN	TYP	MAX	UNIT
OUTPUT VOLTAGE						
V_{OUT}	Output Voltage	REF5020 ($V_{\text{OUT}} = 2.048\ \text{V}$) ⁽¹⁾ , $2.7\ \text{V} < V_{\text{IN}} < 18\ \text{V}$		2.048		V
		REF5025		2.5		
		REF5030		3.0		
		REF5040		4.096		
		REF5050		5.0		
		REF5010		10.0		
	Initial Accuracy: High Grade	All voltage options ⁽¹⁾	-0.05%		0.05%	
	Initial Accuracy: Standard Grade	All voltage options ⁽¹⁾	-0.1%		0.1%	
NOISE						
	Output Voltage Noise	$f = 0.1\ \text{Hz}$ to 10 Hz		3		$\mu\text{V}_{\text{PP}}/\text{V}$
OUTPUT VOLTAGE TEMPERATURE DRIFT						
dV_{OUT}/dT	Output Voltage Temperature Drift					
	High-Grade			2.5	3	ppm/ $^\circ\text{C}$
	Standard-Grade			3	8	ppm/ $^\circ\text{C}$
LINE REGULATION						
$\Delta V_{\text{O}(\Delta V)}$	Line Regulation	$V_{\text{IN}} = (V_{\text{OUT}} + 0.2)$ to 18 V ⁽²⁾		0.1	1	ppm/V
		$V_{\text{IN}} = V_{\text{OUT}} + 0.2\ \text{V}$, $T_A = -40^\circ\text{C}$ to 125 $^\circ\text{C}$ ⁽²⁾		0.2	1	ppm/V
LOAD REGULATION						
$\Delta V_{\text{O}(\Delta I)}$	Load Regulation	$-10\ \text{mA} < I_{\text{LOAD}} < 10\ \text{mA}$, $V_{\text{IN}} = V_{\text{OUT}} + 0.75\ \text{V}$ ⁽³⁾		20	30	ppm/mA
		$-10\ \text{mA} < I_{\text{LOAD}} < 10\ \text{mA}$, $V_{\text{IN}} = V_{\text{OUT}} + 0.75\ \text{V}$, $T_A = -40^\circ\text{C}$ to 125 $^\circ\text{C}$ ⁽³⁾			50	ppm/mA
SHORT-CIRCUIT CURRENT						
I_{SC}	Short circuit current	$V_{\text{OUT}} = 0$		25		mA
THERMAL HYSTERESIS⁽⁴⁾ ⁽⁵⁾						
	High-Grade	VSSOP-8	Cycle 1		50	ppm
	Standard-Grade	VSSOP-8	Cycle 1		70	ppm
	High-Grade	SOIC-8	Cycle 1		70	ppm
	Standard-Grade	SOIC-8	Cycle 1		90	ppm
	High-Grade	VSSOP-8	Cycle 2		40	ppm
	Standard-Grade	VSSOP-8	Cycle 2		40	ppm
	High-Grade	SOIC-8	Cycle 2		50	ppm
	Standard-Grade	SOIC-8	Cycle 2		50	ppm
LONG-TERM STABILITY⁽⁵⁾						
		VSSOP-8	0 to 1000 hours		125	ppm/1000 hr
		VSSOP-8	1000 to 2000 hours		45	ppm/1000 hr
		SOIC-8	0 to 1000 hours		100	ppm/1000 hr
		SOIC-8	1000 to 2000 hours		50	ppm/1000 hr
TEMP PIN						
	Voltage Output	At $T_A = 25^\circ\text{C}$		575		mV
	Temperature Sensitivity	$T_A = -40^\circ\text{C}$ to 125 $^\circ\text{C}$		2.64		mV/ $^\circ\text{C}$
TURNON SETTLING TIME						
	Turnon Settling Time	To 0.1% with $C_L = 1\ \mu\text{F}$		200		μs

(1) For $V_{\text{OUT}} \leq 2.5\ \text{V}$, the minimum supply voltage is 2.7 V.

(2) Except for REF5020, where $V_{\text{IN}} = 2.7\ \text{V}$ to 18 V.

(3) Except for REF5020, where $V_{\text{IN}} = 3\ \text{V}$.

(4) The thermal hysteresis procedure is explained in more detail in the [Thermal Hysteresis](#) section.

(5) Data collected using devices soldered onto the test board.

Electrical Characteristics (continued)

At $T_A = 25^\circ\text{C}$, $I_{\text{LOAD}} = 0$, $C_L = 1 \mu\text{F}$, and $V_{\text{IN}} = (V_{\text{OUT}} + 0.2 \text{ V})$ to 18 V, unless otherwise noted.

PARAMETER		TEST CONDITIONS	MIN	TYP	MAX	UNIT
POWER SUPPLY						
V_S	Supply Voltage	See Note ⁽¹⁾	$V_{\text{OUT}} + 0.2^{(1)}$		18	V
	Quiescent Current			0.8	1	mA
		$T_A = -40^\circ\text{C}$ to 125°C			1.2	mA
TEMPERATURE RANGE						
	Specified Range		-40		125	$^\circ\text{C}$
	Operating Range		-55		125	$^\circ\text{C}$

7.6 Typical Characteristics

At $T_A = 25^\circ\text{C}$, $I_{\text{LOAD}} = 0$, and $V_S = V_{\text{OUT}} + 0.2\text{ V}$, unless otherwise noted. For $V_{\text{OUT}} \leq 2.5\text{ V}$, the minimum supply voltage is 2.7 V.

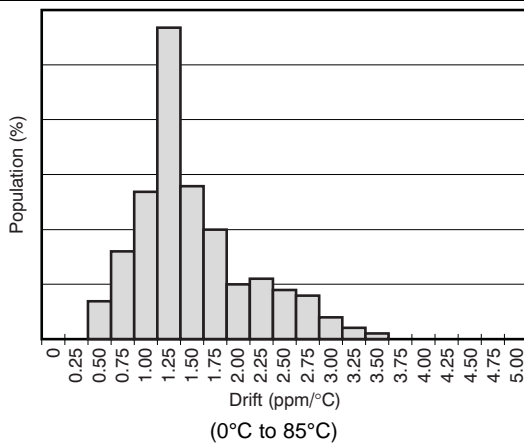

Figure 1. Temperature Drift

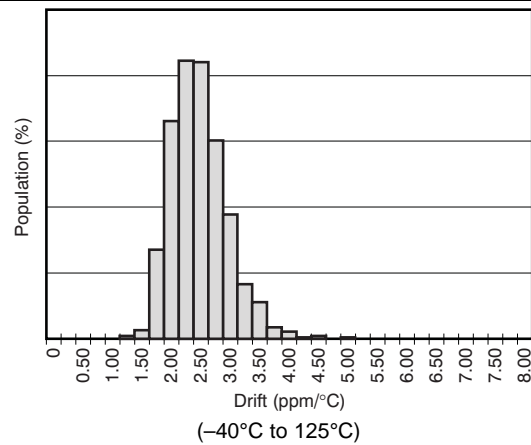

Figure 2. Temperature Drift

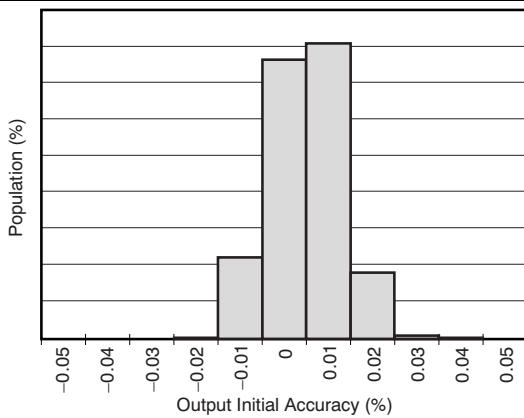

Figure 3. Output Voltage Initial Accuracy

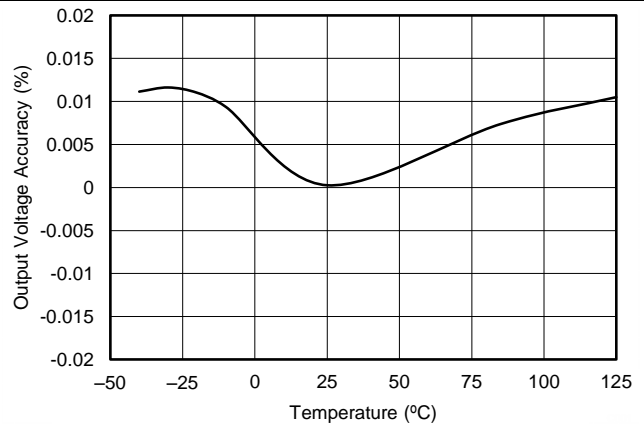

Figure 4. Output Voltage Accuracy vs Temperature

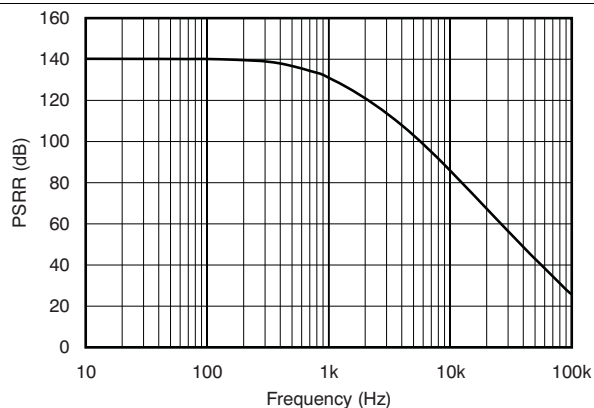

Figure 5. Power-Supply Rejection Ratio vs Frequency

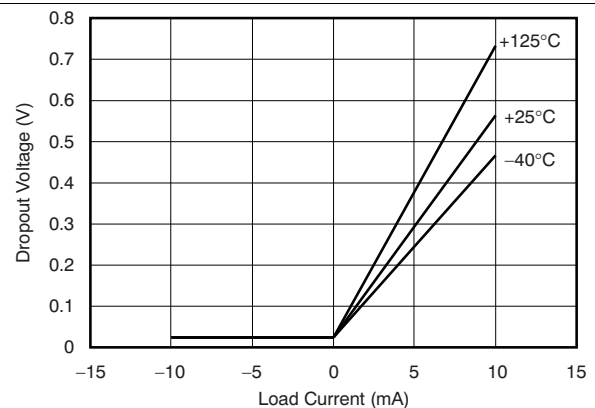

Figure 6. Dropout Voltage vs Load Current

Typical Characteristics (continued)

At $T_A = 25^\circ\text{C}$, $I_{\text{LOAD}} = 0$, and $V_S = V_{\text{OUT}} + 0.2\text{ V}$, unless otherwise noted. For $V_{\text{OUT}} \leq 2.5\text{ V}$, the minimum supply voltage is 2.7 V.

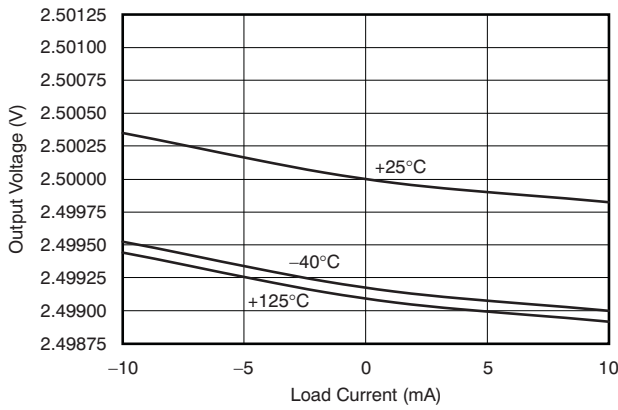

Figure 7. REF5025 Output Voltage vs Load Current

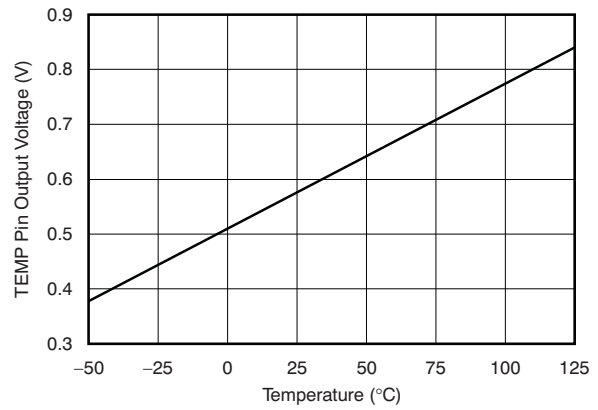

Figure 8. Temp Pin Output Voltage vs Temperature

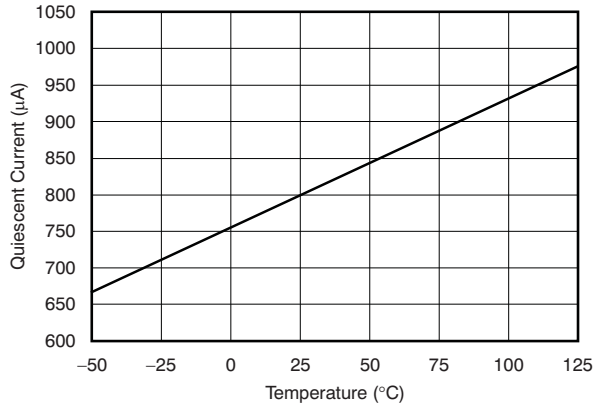

Figure 9. Quiescent Current vs Temperature

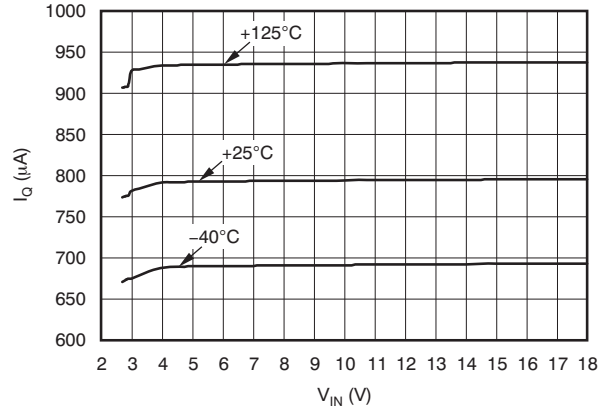

Figure 10. Quiescent Current vs Input Voltage

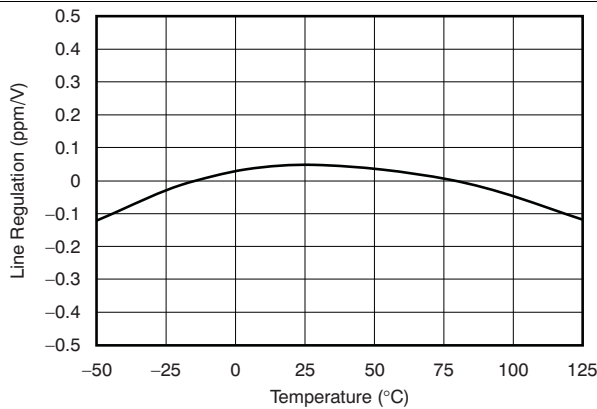

Figure 11. Line Regulation vs Temperature

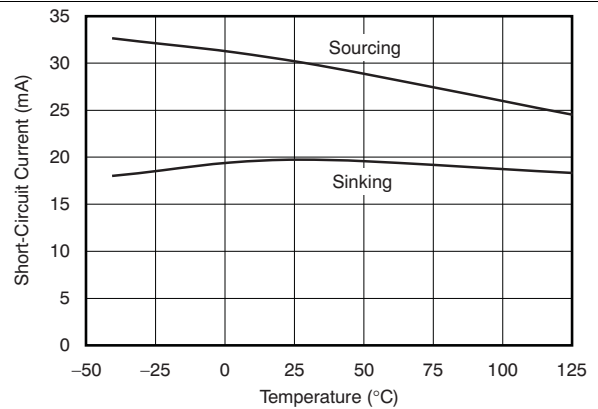

Figure 12. Short Circuit Current vs Temperature

Typical Characteristics (continued)

At $T_A = 25^\circ\text{C}$, $I_{\text{LOAD}} = 0$, and $V_S = V_{\text{OUT}} + 0.2\text{ V}$, unless otherwise noted. For $V_{\text{OUT}} \leq 2.5\text{ V}$, the minimum supply voltage is 2.7 V.

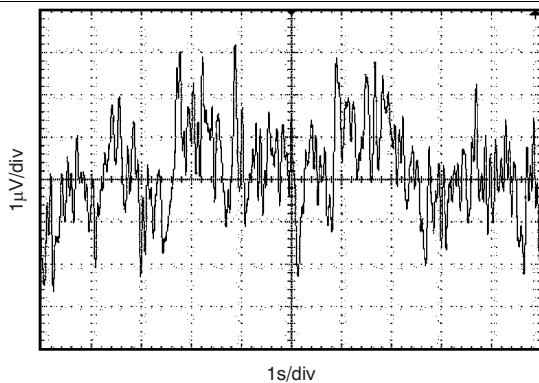
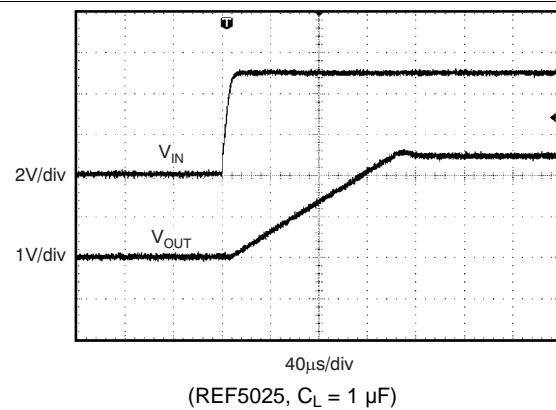
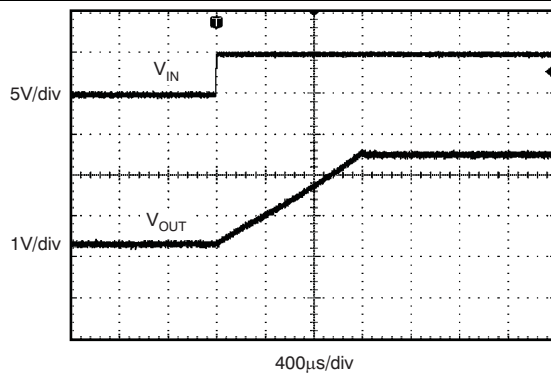

Figure 13. NOISE



(REF5025, $C_L = 1\ \mu\text{F}$)

Figure 14. Start-Up



(REF5025, $C_L = 10\ \mu\text{F}$)

Figure 15. Start-Up

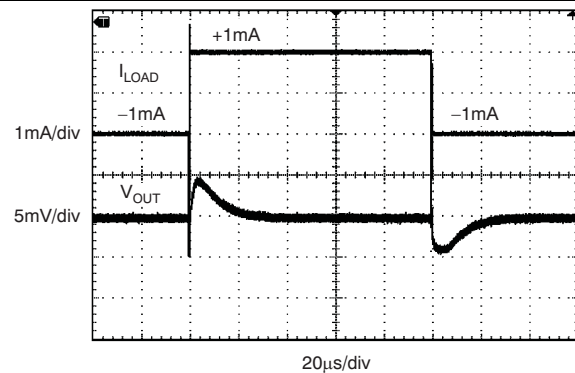

($C_L = 1\ \mu\text{F}$, $I_{\text{OUT}} = 1\text{ mA}$)

Figure 16. Load Transient

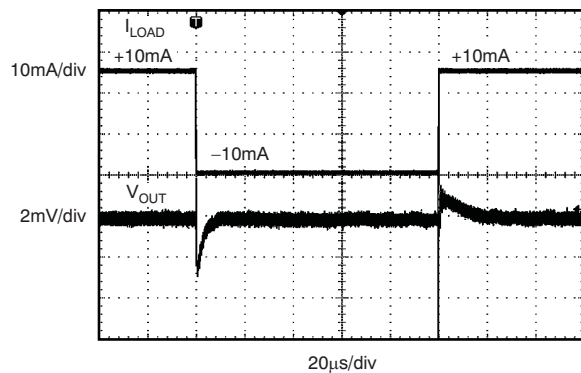

($C_L = 1\ \mu\text{F}$, $I_{\text{OUT}} = 10\text{ mA}$)

Figure 17. Load Transient

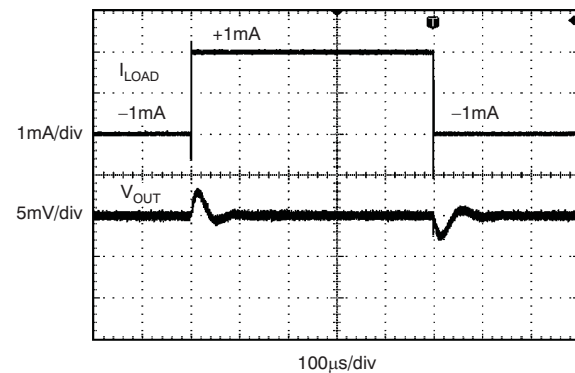

($C_L = 10\ \mu\text{F}$, $I_{\text{OUT}} = 1\text{ mA}$)

Figure 18. Load Transient

Typical Characteristics (continued)

At $T_A = 25^\circ\text{C}$, $I_{\text{LOAD}} = 0$, and $V_S = V_{\text{OUT}} + 0.2 \text{ V}$, unless otherwise noted. For $V_{\text{OUT}} \leq 2.5 \text{ V}$, the minimum supply voltage is 2.7 V.

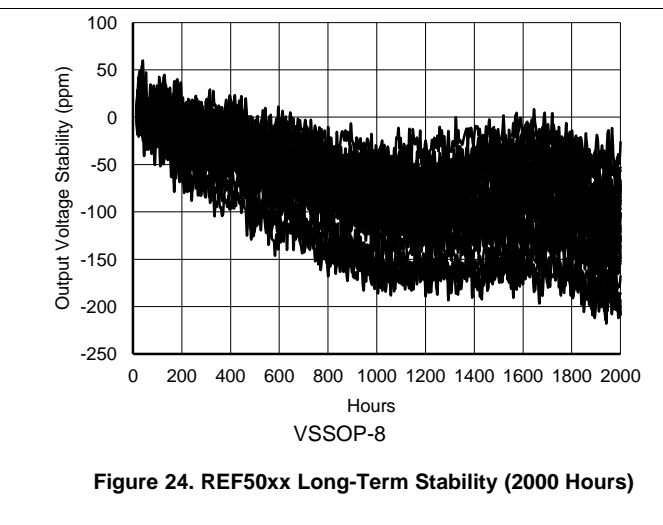
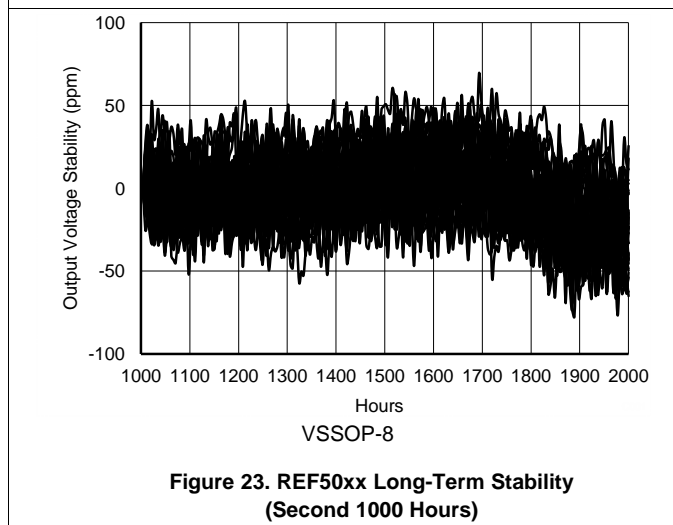
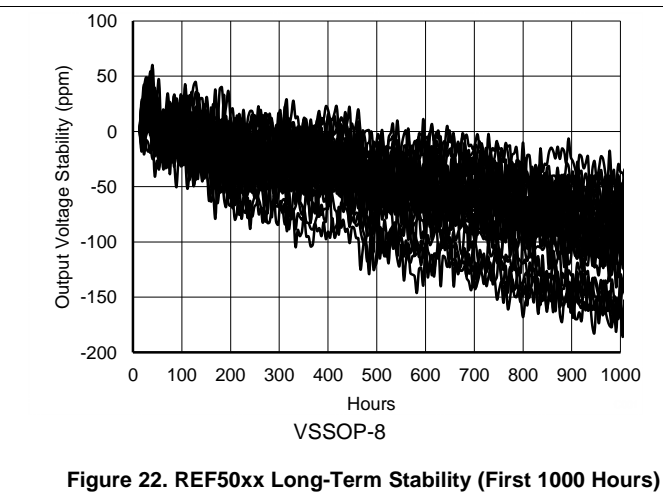
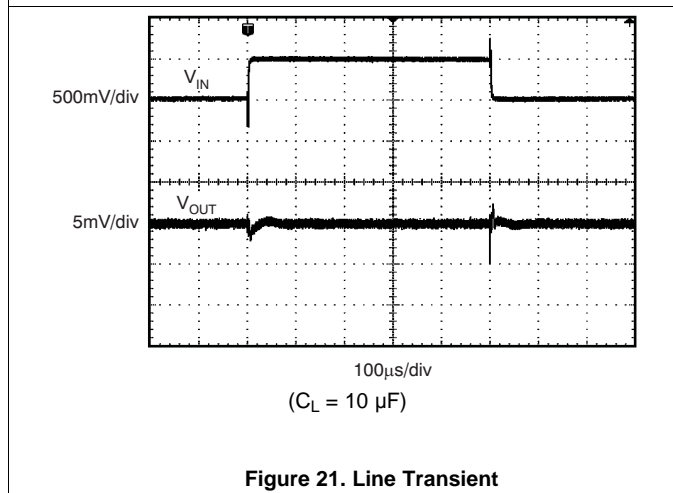
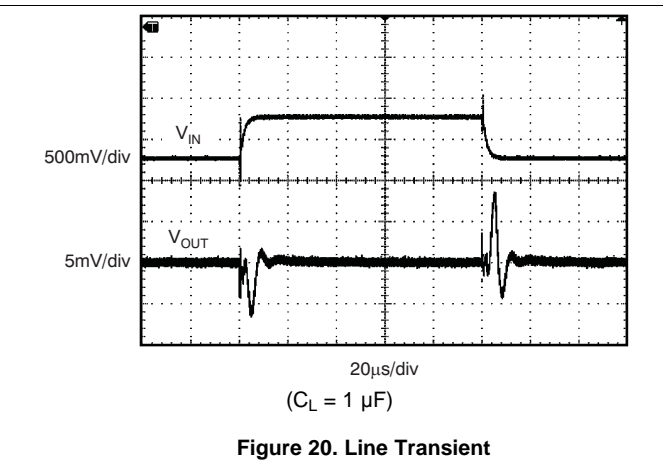
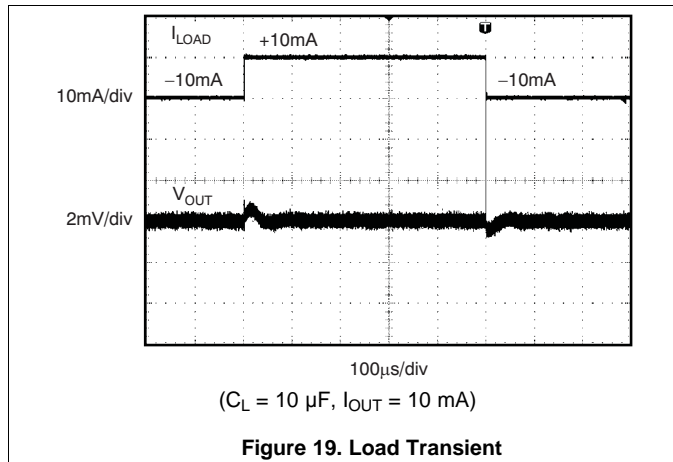

Typical Characteristics (continued)

At $T_A = 25^\circ\text{C}$, $I_{\text{LOAD}} = 0$, and $V_S = V_{\text{OUT}} + 0.2\text{ V}$, unless otherwise noted. For $V_{\text{OUT}} \leq 2.5\text{ V}$, the minimum supply voltage is 2.7 V.

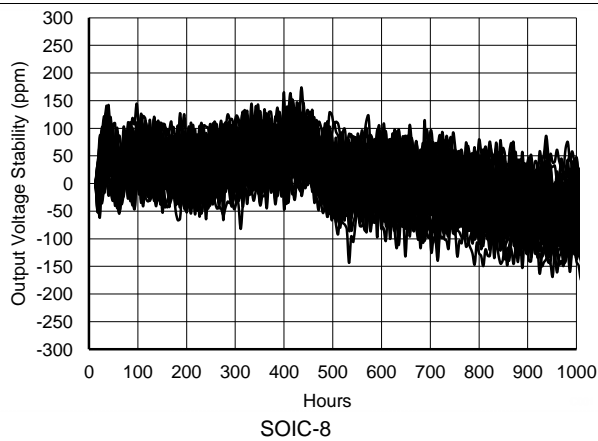

Figure 25. REF50xx Long-Term Stability (First 1000 Hours)

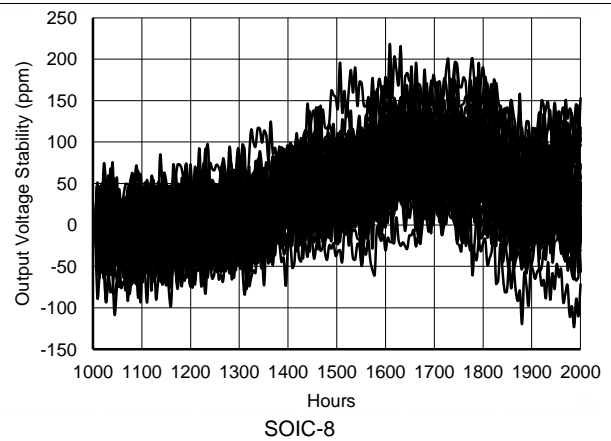

Figure 26. REF50xx Long-Term Stability (Second 1000 Hours)

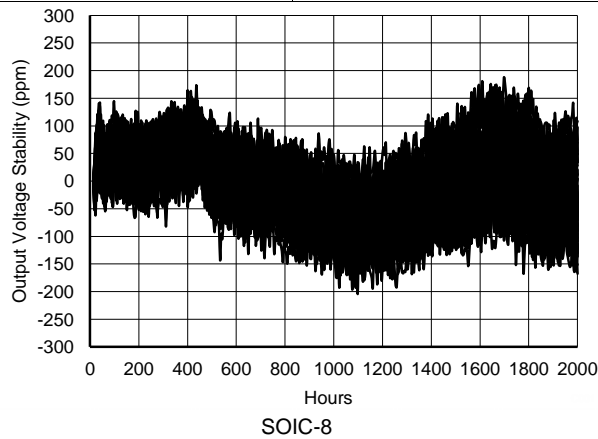

Figure 27. REF50xx Long-Term Stability (2000 Hours)

8 Parameter Measurement Information

8.1 Solder Heat Shift

The materials used in the manufacture of the REF50xx have differing coefficients of thermal expansion, resulting in stress on the device die when the part is heated. Mechanical and thermal stress on the device can cause the output voltages to shift, degrading the initial accuracy and drift specifications of the product. Reflow soldering is a common cause of this error.

To illustrate this effect, a total of 36 devices were soldered on printed-circuit-boards using lead-free solder paste and the paste manufacturer suggested reflow profile. The reflow profile is as shown in [Figure 28](#). The printed-circuit-board is comprised of FR4 material. The board thickness is 0.8 mm and the area is 13 mm × 13 mm.

The reference voltage is measured before and after the reflow process across temperature; the typical shift of accuracy and drift is displayed in [Figure 29](#) through [Figure 36](#). Although all tested units exhibit very low shifts, higher shifts are also possible depending on the size, thickness, and material of the printed-circuit-board. An important note is that the histograms display the typical shift for exposure to a single reflow profile. Exposure to multiple reflows, as is common on printed circuit boards (PCBs) with surface-mount components on both sides, causes additional shifts in the output bias voltage. If the PCB is exposed to multiple reflows, then solder the device in the last pass to minimize device exposure to thermal stress.

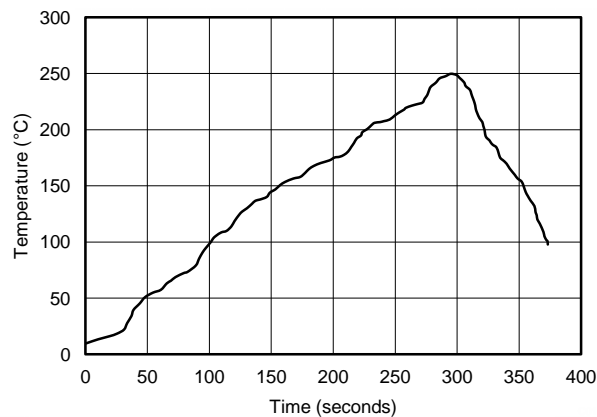

Figure 28. Reflow Profile

Solder Heat Shift (continued)

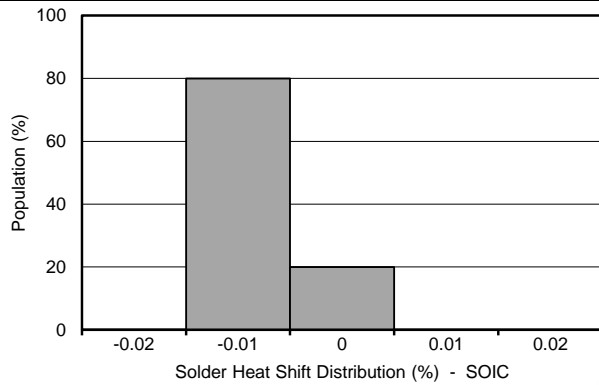

Figure 29. Solder Heat Shift Distribution (%), SOIC Package

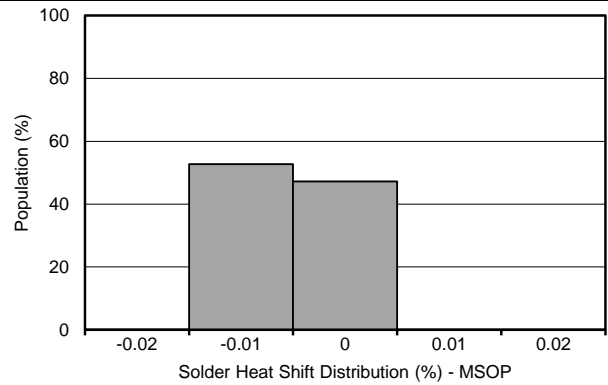

Figure 30. Solder Heat Shift Distribution (%), VSSOP Package

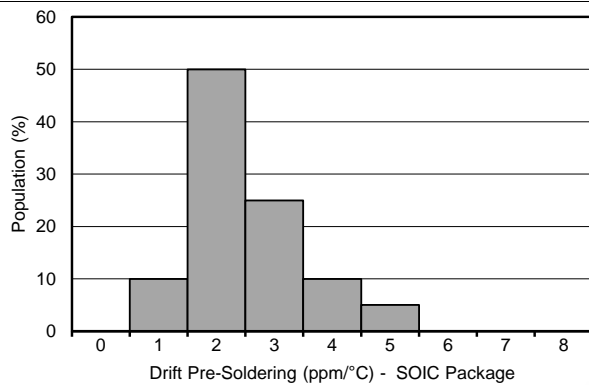

Figure 31. Drift Pre-Soldering Distribution, SOIC Package

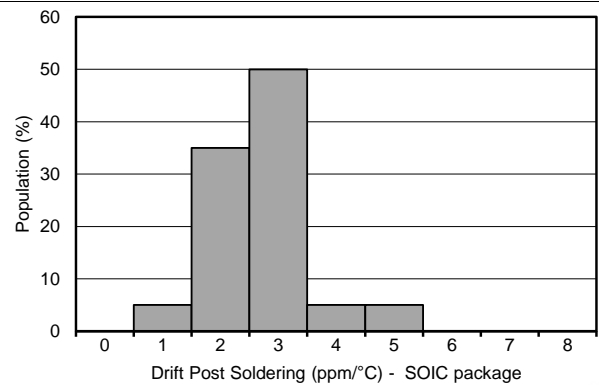

Figure 32. Drift Post Soldering Distribution, SOIC Package

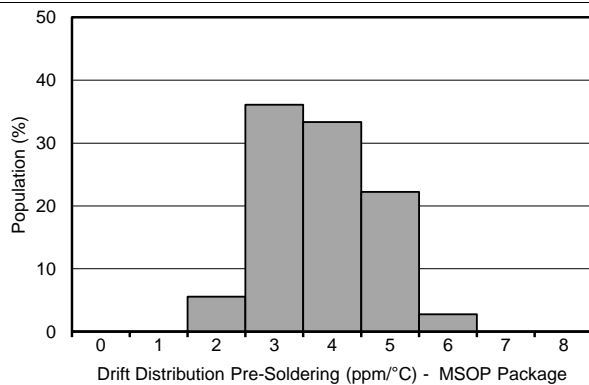

Figure 33. Drift Distribution Pre-Soldering, VSSOP Package

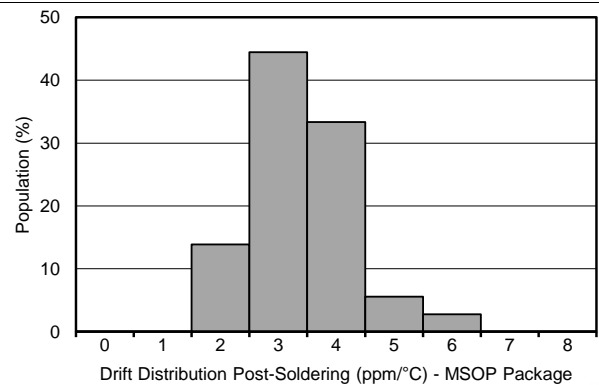
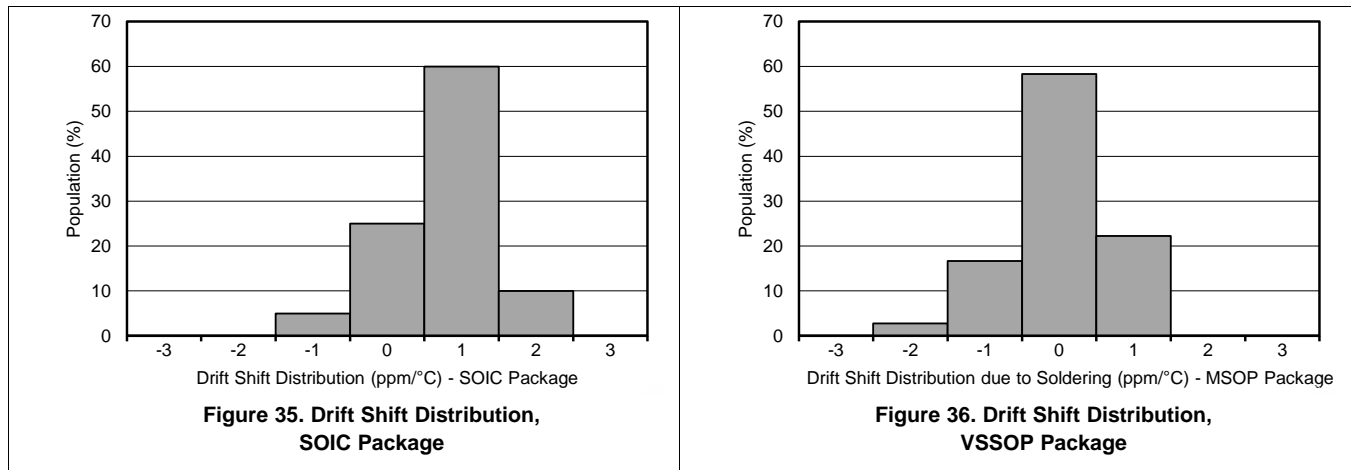

Figure 34. Drift Distribution Post-Soldering, VSSOP Package

Solder Heat Shift (continued)



9 Detailed Description

9.1 Overview

The REF50xx is family of low-noise, precision bandgap voltage references that are specifically designed for excellent initial voltage accuracy and drift. See the [Functional Block Diagram](#) for a simplified block diagram of the REF50xx.

9.2 Functional Block Diagram

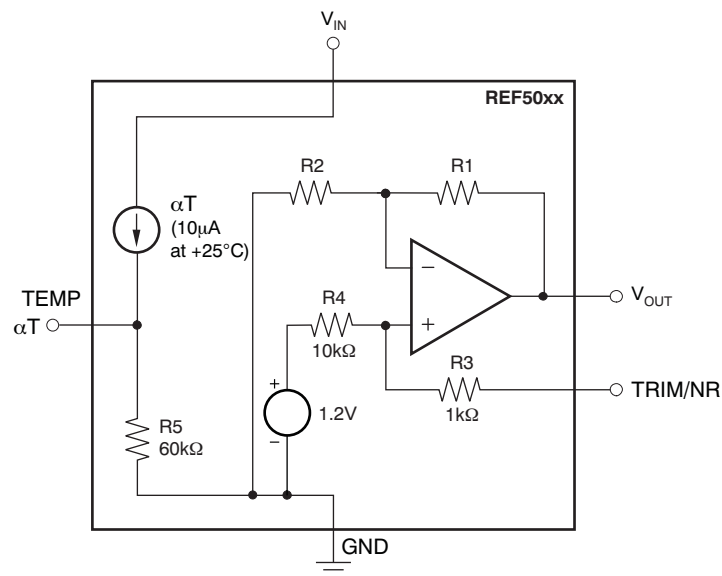

9.3 Feature Description

9.3.1 Temperature Monitoring

The temperature output terminal (TEMP, pin 3) provides a temperature-dependent voltage output with approximately 60-k Ω source impedance. As illustrated in Figure 8, the output voltage follows the nominal relationship:

$$V_{\text{TEMP PIN}} = 509 \text{ mV} + 2.64 \times T(^{\circ}\text{C}) \quad (1)$$

This pin indicates general chip temperature, accurate to approximately $\pm 15^{\circ}\text{C}$. Although not generally suitable for accurate temperature measurements, this pin can be used to indicate temperature changes or for temperature compensation of analog circuitry. A temperature change of 30°C corresponds to an approximate 79-mV change in voltage at the TEMP pin.

The TEMP pin has high-output impedance (see the *Functional Block Diagram*). Loading this pin with a low-impedance circuit induces a measurement error; however, this pin does not have any effect on V_{OUT} accuracy.

To avoid errors caused by low-impedance loading, buffer the TEMP pin output with a suitable low-temperature drift op amp, such as the OPA333, OPA335, or OPA376, as shown in Figure 37.

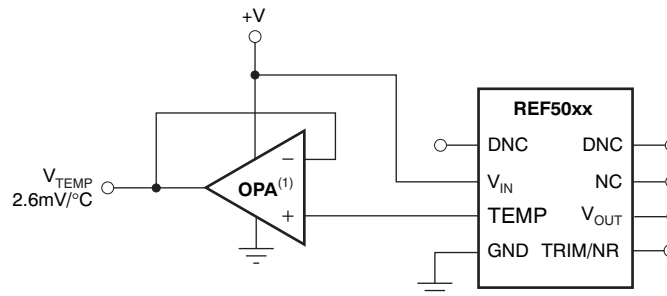

NOTE: (1) Low drift op amp, such as the OPA333, OPA335, or OPA376.

Figure 37. Buffering the TEMP Pin Output

9.3.2 Temperature Drift

The REF50xx is designed for minimal drift error, which is defined as the change in output voltage over temperature. The drift is calculated using the box method, as described in Equation 2.

$$\text{Drift} = \left(\frac{V_{\text{OUTMAX}} - V_{\text{OUTMIN}}}{V_{\text{OUT}} \times \text{Temp Range}} \right) \times 10^6 (\text{ppm}) \quad (2)$$

The REF50xx features a maximum drift coefficient of 3 ppm/ $^{\circ}\text{C}$ for the high-grade version, and 8 ppm/ $^{\circ}\text{C}$ for the standard-grade.

9.3.3 Thermal Hysteresis

Thermal hysteresis for the REF50xx is defined as the change in output voltage after operating the device at 25°C , cycling the device through the specified temperature range, and returning to 25°C . Thermal hysteresis can be expressed as Equation 3:

$$V_{\text{HYST}} = \left(\frac{|V_{\text{PRE}} - V_{\text{POST}}|}{V_{\text{NOM}}} \right) \cdot 10^6 (\text{ppm})$$

where

- V_{HYST} = thermal hysteresis (in units of ppm).
 - V_{NOM} = the specified output voltage.
 - V_{PRE} = output voltage measured at 25°C pretemperature cycling.
 - V_{POST} = output voltage measured after the device has been cycled from 25°C through the specified temperature range of -40°C to 125°C and returned to 25°C .
- (3)

Feature Description (continued)

9.3.4 Noise Performance

Typical 0.1-Hz to 10-Hz voltage noise for each member of the REF50xx family is specified in the [Electrical Characteristics](#) table. The noise voltage increases with output voltage and operating temperature. Additional filtering can be used to improve output noise levels, although take care to ensure the output impedance does not degrade performance.

For additional information about how to minimize noise and maximize performance in mixed-signal applications such as data converters, refer to the series of *Analog Applications Journal* articles entitled, *How a Voltage Reference Affects ADC Performance*. This three-part series is available for download from the TI website under three literature numbers: [SLYT331](#), [SLYT339](#), and [SLYT355](#) for [Part I](#), [Part II](#), and [Part III](#), respectively.

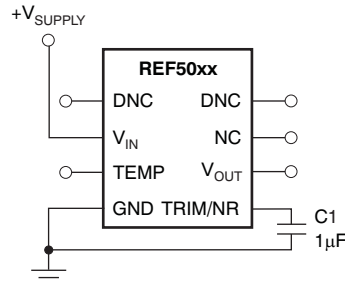

Figure 38. Noise Reduction Using the TRIM/NR Pin

9.3.5 Output Adjustment Using the TRIM/NR Pin

The REF50xx provides a very accurate, factory-trimmed voltage output. However, V_{OUT} can be adjusted using the trim and noise reduction pin (TRIM/NR, pin 5). [Figure 39](#) shows a typical circuit that allows an output adjustment of $\pm 15\text{mV}$

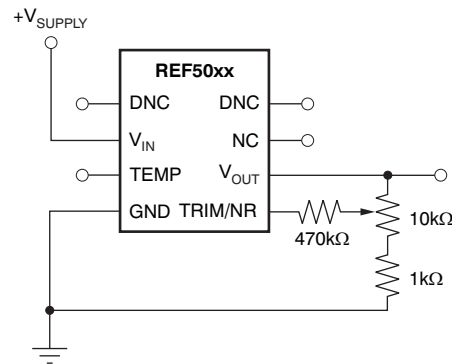

Figure 39. V_{OUT} Adjustment Using the TRIM/NR Pin

The REF50xx allows access to the bandgap through the TRIM/NR pin. Placing a capacitor from the TRIM/NR pin to GND ([Figure 38](#)) in combination with the internal R_3 and R_4 resistors creates a low-pass filter. A capacitance of $1\mu\text{F}$ creates a low-pass filter with the corner frequency from 10 Hz to 20 Hz. Such a filter decreases the overall noise measured on the V_{OUT} pin by half. Higher capacitance results in a lower filter cutoff frequency, further reducing output noise. Using this capacitor increases start-up time.

10 Applications and Implementation

NOTE

Information in the following applications sections is not part of the TI component specification, and TI does not warrant its accuracy or completeness. TI's customers are responsible for determining suitability of components for their purposes. Customers should validate and test their design implementation to confirm system functionality.

10.1 Application Information

Data acquisition systems often require stable voltage references to maintain accuracy. The REF50xx family features low noise, very low drift, and high initial accuracy for high-performance data converters. Figure 42 shows the REF5040 in a basic data acquisition system.

10.2 Typical Applications

10.2.1 16-bit, 250-KSPS Data Acquisition System

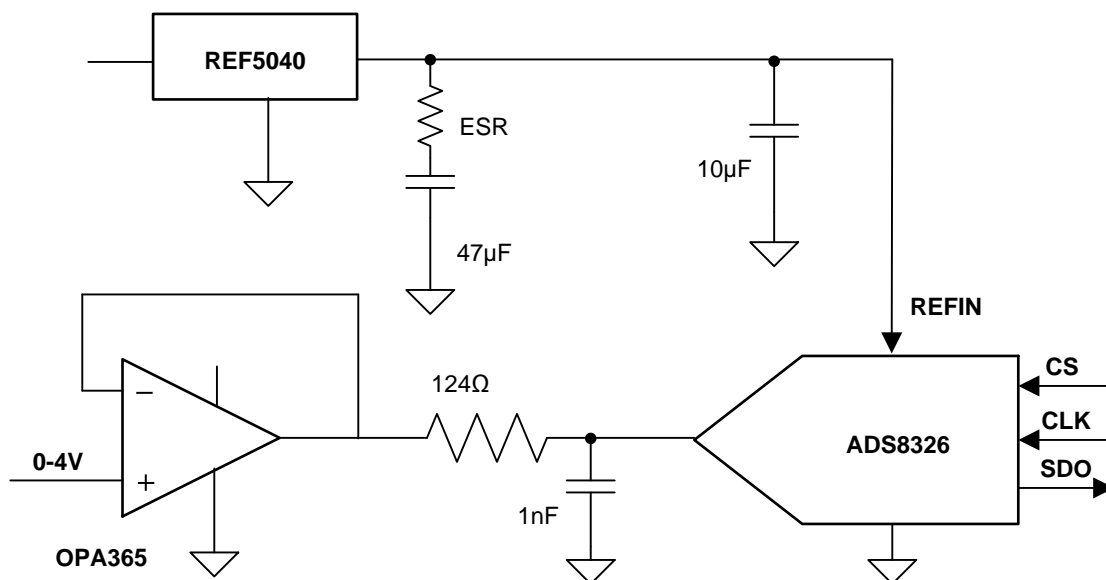

Figure 42. Complete Data Acquisition System Using REF50xx

10.2.1.1 Design Requirements

When using the REF50xx in the design, select a proper output capacitor that does not create gain peaking, thereby increasing total system noise. At the same time, the capacitor must be selected to provide required filtering performance for the system. In addition, input bypass capacitor and noise reduction capacitors must be added for optimum performances. During the design of the data acquisition system, equal consideration must be given to the buffering analog input signal as well as the reference voltage. Having a properly designed input buffer with an associated RC filter is a necessary requirement for good performance of the Data Acquisition System.

10.2.1.2 Detailed Design Procedure

The OPA365 is used to drive the 16-bit Analog to Digital Converter (ADS8326). The RC filter at the output of the OPA365 is used to reduce the charge kick-back created by the opening and closing of the sampling switch inside the ADC. Design the RC filter such that the voltage at the sampling capacitor settles to 16-bit accuracy within the acquisition time of the ADC. The bandwidth of the driving amplifier must at least be 4 times the bandwidth of the RC filter.

Typical Applications (continued)

The REF5040 is used to drive the REF pin of the ADS8326. Proper selection of Voltage Reference output capacitor is very important for this design. Very Low equivalent series resistance (ESR) creates gain-peaking which degrades SNR of the total system. If the ESR of the capacitor is not enough, then an additional resistor must be added in series with the output capacitor. A capacitance of 1 μF can be connected to the NR pin to reduce bandgap noise of the REF50xx.

SNR Measurements using different RC filters at the output of OPA365, different values of output capacitor for the REF50xx and different values of capacitors at the TRIM/NR pin are shown in [Table 1](#).

Table 1. Data Acquisition Measurement Results for Different Conditions

	TEST CONDITION 1	TEST CONDITION 2
OPA365 RC filter	124 Ω , 1 nF	124 Ω , 1 nF
REF5040 Output capacitor	10 μF	10 μF + 47 μF
TRIM /NR pin capacitor	0 μF	1 μF
SNR	86.7 dB	92.8 dB

10.2.1.3 Application Curve

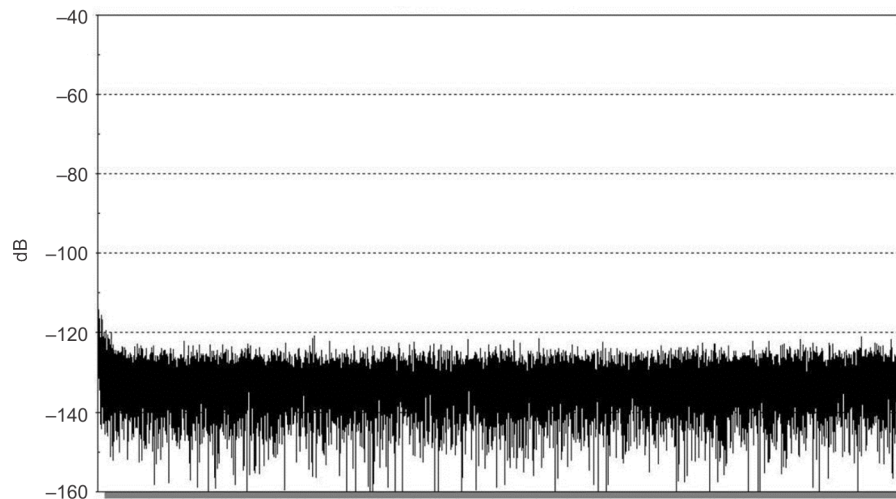

Figure 43. FFT plot- Noise floor of Data Acquisition system

11 Power Supply Recommendations

The REF50xx family of voltage references features extremely low dropout voltage. With the exception of the REF5020, which has a minimum supply requirement of 2.7 V, these references can be operated with a supply of 200 mV more than the output voltage in an unloaded condition. For loaded conditions, a typical dropout voltage versus load plot is provided in [Figure 6](#) in the *Typical Characteristics*. TI recommends a supply bypass capacitor ranging from 1 μF to 50 μF .

12 Layout

12.1 Layout Guidelines

- Place the power-supply bypass capacitor as closely as possible to the supply and ground pins. The recommended value of this bypass capacitor is from 1 μF to 10 μF . If necessary, additional decoupling capacitance can be added to compensate for noisy or high-impedance power supplies.
- Place a 1- μF noise filtering capacitor between the NR pin and ground.
- The output must be decoupled with a 1- μF to 50- μF capacitor. A resistor in series with the output capacitor is optional. For better noise performance, the recommended ESR on the output capacitor is from 1 Ω to 1.5 Ω .
- A high-frequency, 1- μF capacitor can be added in parallel between the output and ground to filter noise and help with switching loads as data converters.

12.2 Layout Example

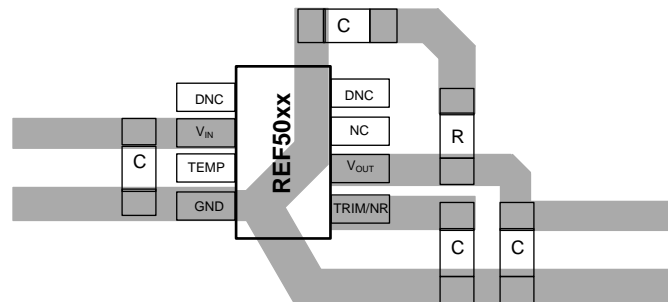

Figure 44. Layout Example

12.3 Power Dissipation

The REF50xx family is specified to deliver current loads of ± 10 mA over the specified input voltage range. The temperature of the device increases according to [Equation 4](#):

$$T_J = T_A + P_D \times \theta_{JA}$$

where

- T_J = Junction temperature ($^{\circ}\text{C}$)
 - T_A = Ambient temperature ($^{\circ}\text{C}$)
 - P_D = Power dissipated (W)
 - θ_{JA} = Junction-to-ambient thermal resistance ($^{\circ}\text{C}/\text{W}$)
- (4)

The REF50xx junction temperature must not exceed the absolute maximum rating of 150 $^{\circ}\text{C}$.

13 Device and Documentation Support

13.1 Documentation Support

13.1.1 Related Documentation

For related documentation see the following:

- *0.05uV/degC (max), Single-Supply CMOS Zero-Drift Series Operational Amplifier*, [SBOS282](#).
- *REF5020 PSpice Model*, [SLIM160](#).
- *REF5020 TINA-TI Reference Design*, [SLIM159](#).
- *REF5020 TINA-TI Spice Model*, [SLIM158](#).
- *INA270 PSpice Model*, [SBOM485](#).
- *INA270 TINA-TI Reference Design*, [SBOC246](#).
- *INA270 TINA-TI Spice Model*, [SBOM306](#).

13.2 Related Links

The table below lists quick access links. Categories include technical documents, support and community resources, tools and software, and quick access to sample or buy.

Table 2. Related Links

PARTS	PRODUCT FOLDER	SAMPLE & BUY	TECHNICAL DOCUMENTS	TOOLS & SOFTWARE	SUPPORT & COMMUNITY
REF5010	Click here	Click here	Click here	Click here	Click here
REF5020	Click here	Click here	Click here	Click here	Click here
REF5025	Click here	Click here	Click here	Click here	Click here
REF5030	Click here	Click here	Click here	Click here	Click here
REF5040	Click here	Click here	Click here	Click here	Click here
REF5045	Click here	Click here	Click here	Click here	Click here
REF5050	Click here	Click here	Click here	Click here	Click here

13.3 Community Resources

The following links connect to TI community resources. Linked contents are provided "AS IS" by the respective contributors. They do not constitute TI specifications and do not necessarily reflect TI's views; see TI's [Terms of Use](#).

TI E2E™ Online Community *TI's Engineer-to-Engineer (E2E) Community*. Created to foster collaboration among engineers. At [e2e.ti.com](#), you can ask questions, share knowledge, explore ideas and help solve problems with fellow engineers.

Design Support *TI's Design Support* Quickly find helpful E2E forums along with design support tools and contact information for technical support.

13.4 Trademarks

E2E is a trademark of Texas Instruments.
All other trademarks are the property of their respective owners.

13.5 Electrostatic Discharge Caution



These devices have limited built-in ESD protection. The leads should be shorted together or the device placed in conductive foam during storage or handling to prevent electrostatic damage to the MOS gates.

13.6 Glossary

[SLYZ022](#) — *TI Glossary*.

This glossary lists and explains terms, acronyms, and definitions.

14 Mechanical, Packaging, and Orderable Information

The following pages include mechanical, packaging, and orderable information. This information is the most current data available for the designated devices. This data is subject to change without notice and revision of this document. For browser-based versions of this data sheet, refer to the left-hand navigation.

PACKAGING INFORMATION

Orderable Device	Status (1)	Package Type	Package Drawing	Pins	Package Qty	Eco Plan (2)	Lead/Ball Finish (6)	MSL Peak Temp (3)	Op Temp (°C)	Device Marking (4/5)	Samples
REF5010AID	ACTIVE	SOIC	D	8	75	Green (RoHS & no Sb/Br)	CU NIPDAU	Level-2-260C-1 YEAR	-40 to 125	REF 5010 A	Samples
REF5010AIDGKR	ACTIVE	VSSOP	DGK	8	2500	Green (RoHS & no Sb/Br)	CU NIPDAU	Level-2-260C-1 YEAR	-40 to 125	R50G	Samples
REF5010AIDGKT	ACTIVE	VSSOP	DGK	8	250	Green (RoHS & no Sb/Br)	CU NIPDAU	Level-2-260C-1 YEAR	-40 to 125	R50G	Samples
REF5010AIDR	ACTIVE	SOIC	D	8	2500	Green (RoHS & no Sb/Br)	CU NIPDAU	Level-2-260C-1 YEAR	-40 to 125	REF 5010 A	Samples
REF5010ID	ACTIVE	SOIC	D	8	75	Green (RoHS & no Sb/Br)	CU NIPDAU	Level-2-260C-1 YEAR	-40 to 125	REF 5010	Samples
REF5010IDGKR	ACTIVE	VSSOP	DGK	8	2500	Green (RoHS & no Sb/Br)	CU NIPDAU	Level-2-260C-1 YEAR	-40 to 125	R50G	Samples
REF5010IDGKT	ACTIVE	VSSOP	DGK	8	250	Green (RoHS & no Sb/Br)	CU NIPDAU	Level-2-260C-1 YEAR	-40 to 125	R50G	Samples
REF5020AID	ACTIVE	SOIC	D	8	75	Green (RoHS & no Sb/Br)	CU NIPDAU	Level-2-260C-1 YEAR	-40 to 125	REF 5020 A	Samples
REF5020AIDG4	ACTIVE	SOIC	D	8	75	Green (RoHS & no Sb/Br)	CU NIPDAU	Level-2-260C-1 YEAR	-40 to 125	REF 5020 A	Samples
REF5020AIDGKR	ACTIVE	VSSOP	DGK	8	2500	Green (RoHS & no Sb/Br)	CU NIPDAU	Level-2-260C-1 YEAR	-40 to 125	R50A	Samples
REF5020AIDGKT	ACTIVE	VSSOP	DGK	8	250	Green (RoHS & no Sb/Br)	CU NIPDAU	Level-2-260C-1 YEAR	-40 to 125	R50A	Samples
REF5020AIDR	ACTIVE	SOIC	D	8	2500	Green (RoHS & no Sb/Br)	CU NIPDAU	Level-2-260C-1 YEAR	-40 to 125	REF 5020 A	Samples
REF5020AIDRG4	ACTIVE	SOIC	D	8	2500	Green (RoHS & no Sb/Br)	CU NIPDAU	Level-2-260C-1 YEAR	-40 to 125	REF 5020 A	Samples
REF5020ID	ACTIVE	SOIC	D	8	75	Green (RoHS & no Sb/Br)	CU NIPDAU	Level-2-260C-1 YEAR	-40 to 125	REF 5020	Samples

Orderable Device	Status (1)	Package Type	Package Drawing	Pins	Package Qty	Eco Plan (2)	Lead/Ball Finish (6)	MSL Peak Temp (3)	Op Temp (°C)	Device Marking (4/5)	Samples
REF5020IDG4	ACTIVE	SOIC	D	8	75	Green (RoHS & no Sb/Br)	CU NIPDAU	Level-2-260C-1 YEAR	-40 to 125	REF 5020	Samples
REF5020IDGKR	ACTIVE	VSSOP	DGK	8	2500	Green (RoHS & no Sb/Br)	CU NIPDAU	Level-2-260C-1 YEAR	-40 to 125	R50A	Samples
REF5020IDGKT	ACTIVE	VSSOP	DGK	8	250	Green (RoHS & no Sb/Br)	CU NIPDAU	Level-2-260C-1 YEAR	-40 to 125	R50A	Samples
REF5020IDR	ACTIVE	SOIC	D	8	2500	Green (RoHS & no Sb/Br)	CU NIPDAU	Level-2-260C-1 YEAR	-40 to 125	REF 5020	Samples
REF5020IDRG4	ACTIVE	SOIC	D	8	2500	Green (RoHS & no Sb/Br)	CU NIPDAU	Level-2-260C-1 YEAR	-40 to 125	REF 5020	Samples
REF5025AID	ACTIVE	SOIC	D	8	75	Green (RoHS & no Sb/Br)	CU NIPDAU	Level-2-260C-1 YEAR	-40 to 125	REF 5025 A	Samples
REF5025AIDG4	ACTIVE	SOIC	D	8	75	Green (RoHS & no Sb/Br)	CU NIPDAU	Level-2-260C-1 YEAR	-40 to 125	REF 5025 A	Samples
REF5025AIDGKR	ACTIVE	VSSOP	DGK	8	2500	Green (RoHS & no Sb/Br)	CU NIPDAU	Level-2-260C-1 YEAR	-40 to 125	R50B	Samples
REF5025AIDGKT	ACTIVE	VSSOP	DGK	8	250	Green (RoHS & no Sb/Br)	CU NIPDAU	Level-2-260C-1 YEAR	-40 to 125	R50B	Samples
REF5025AIDR	ACTIVE	SOIC	D	8	2500	Green (RoHS & no Sb/Br)	CU NIPDAU	Level-2-260C-1 YEAR	-40 to 125	REF 5025 A	Samples
REF5025AIDRG4	ACTIVE	SOIC	D	8	2500	Green (RoHS & no Sb/Br)	CU NIPDAU	Level-2-260C-1 YEAR	-40 to 125	REF 5025 A	Samples
REF5025ID	ACTIVE	SOIC	D	8	75	Green (RoHS & no Sb/Br)	CU NIPDAU	Level-2-260C-1 YEAR	-40 to 125	REF 5025	Samples
REF5025IDG4	ACTIVE	SOIC	D	8	75	Green (RoHS & no Sb/Br)	CU NIPDAU	Level-2-260C-1 YEAR	-40 to 125	REF 5025	Samples
REF5025IDGKR	ACTIVE	VSSOP	DGK	8	2500	Green (RoHS & no Sb/Br)	CU NIPDAU	Level-2-260C-1 YEAR	-40 to 125	R50B	Samples
REF5025IDGKT	ACTIVE	VSSOP	DGK	8	250	Green (RoHS & no Sb/Br)	CU NIPDAU	Level-2-260C-1 YEAR	-40 to 125	R50B	Samples
REF5025IDR	ACTIVE	SOIC	D	8	2500	Green (RoHS & no Sb/Br)	CU NIPDAU	Level-2-260C-1 YEAR	-40 to 125	REF 5025	Samples

Orderable Device	Status (1)	Package Type	Package Drawing	Pins	Package Qty	Eco Plan (2)	Lead/Ball Finish (6)	MSL Peak Temp (3)	Op Temp (°C)	Device Marking (4/5)	Samples
REF5025IDRG4	ACTIVE	SOIC	D	8	2500	Green (RoHS & no Sb/Br)	CU NIPDAU	Level-2-260C-1 YEAR	-40 to 125	REF 5025	Samples
REF5030AID	ACTIVE	SOIC	D	8	75	Green (RoHS & no Sb/Br)	CU NIPDAU	Level-2-260C-1 YEAR	-40 to 125	REF 5030 A	Samples
REF5030AIDG4	ACTIVE	SOIC	D	8	75	Green (RoHS & no Sb/Br)	CU NIPDAU	Level-2-260C-1 YEAR	-40 to 125	REF 5030 A	Samples
REF5030AIDGKR	ACTIVE	VSSOP	DGK	8	2500	Green (RoHS & no Sb/Br)	CU NIPDAU	Level-2-260C-1 YEAR	-40 to 125	R50C	Samples
REF5030AIDGKT	ACTIVE	VSSOP	DGK	8	250	Green (RoHS & no Sb/Br)	CU NIPDAU	Level-2-260C-1 YEAR	-40 to 125	R50C	Samples
REF5030AIDR	ACTIVE	SOIC	D	8	2500	Green (RoHS & no Sb/Br)	CU NIPDAU	Level-2-260C-1 YEAR	-40 to 125	REF 5030 A	Samples
REF5030AIDRG4	ACTIVE	SOIC	D	8	2500	Green (RoHS & no Sb/Br)	CU NIPDAU	Level-2-260C-1 YEAR	-40 to 125	REF 5030 A	Samples
REF5030ID	ACTIVE	SOIC	D	8	75	Green (RoHS & no Sb/Br)	CU NIPDAU	Level-2-260C-1 YEAR	-40 to 125	REF 5030	Samples
REF5030IDG4	ACTIVE	SOIC	D	8	75	Green (RoHS & no Sb/Br)	CU NIPDAU	Level-2-260C-1 YEAR	-40 to 125	REF 5030	Samples
REF5030IDGKR	ACTIVE	VSSOP	DGK	8	2500	Green (RoHS & no Sb/Br)	CU NIPDAU	Level-2-260C-1 YEAR	-40 to 125	R50C	Samples
REF5030IDGKT	ACTIVE	VSSOP	DGK	8	250	Green (RoHS & no Sb/Br)	CU NIPDAU	Level-2-260C-1 YEAR	-40 to 125	R50C	Samples
REF5030IDR	ACTIVE	SOIC	D	8	2500	Green (RoHS & no Sb/Br)	CU NIPDAU	Level-2-260C-1 YEAR	-40 to 125	REF 5030	Samples
REF5040AID	ACTIVE	SOIC	D	8	75	Green (RoHS & no Sb/Br)	CU NIPDAU	Level-2-260C-1 YEAR	-40 to 125	REF 5040 A	Samples
REF5040AIDG4	ACTIVE	SOIC	D	8	75	Green (RoHS & no Sb/Br)	CU NIPDAU	Level-2-260C-1 YEAR	-40 to 125	REF 5040 A	Samples
REF5040AIDGKR	ACTIVE	VSSOP	DGK	8	2500	Green (RoHS & no Sb/Br)	CU NIPDAU	Level-2-260C-1 YEAR	-40 to 125	R50D	Samples

Orderable Device	Status (1)	Package Type	Package Drawing	Pins	Package Qty	Eco Plan (2)	Lead/Ball Finish (6)	MSL Peak Temp (3)	Op Temp (°C)	Device Marking (4/5)	Samples
REF5040AIDGKT	ACTIVE	VSSOP	DGK	8	250	Green (RoHS & no Sb/Br)	CU NIPDAU	Level-2-260C-1 YEAR	-40 to 125	R50D	Samples
REF5040AIDR	ACTIVE	SOIC	D	8	2500	Green (RoHS & no Sb/Br)	CU NIPDAU	Level-2-260C-1 YEAR	-40 to 125	REF 5040 A	Samples
REF5040ID	ACTIVE	SOIC	D	8	75	Green (RoHS & no Sb/Br)	CU NIPDAU	Level-2-260C-1 YEAR	-40 to 125	REF 5040	Samples
REF5040IDG4	ACTIVE	SOIC	D	8	75	Green (RoHS & no Sb/Br)	CU NIPDAU	Level-2-260C-1 YEAR	-40 to 125	REF 5040	Samples
REF5040IDGKR	ACTIVE	VSSOP	DGK	8	2500	Green (RoHS & no Sb/Br)	CU NIPDAU	Level-2-260C-1 YEAR	-40 to 125	R50D	Samples
REF5040IDGKT	ACTIVE	VSSOP	DGK	8	250	Green (RoHS & no Sb/Br)	CU NIPDAU	Level-2-260C-1 YEAR	-40 to 125	R50D	Samples
REF5040IDR	ACTIVE	SOIC	D	8	2500	Green (RoHS & no Sb/Br)	CU NIPDAU	Level-2-260C-1 YEAR	-40 to 125	REF 5040	Samples
REF5040IDRG4	ACTIVE	SOIC	D	8	2500	Green (RoHS & no Sb/Br)	CU NIPDAU	Level-2-260C-1 YEAR	-40 to 125	REF 5040	Samples
REF5045AID	ACTIVE	SOIC	D	8	75	Green (RoHS & no Sb/Br)	CU NIPDAU	Level-2-260C-1 YEAR	-40 to 125	REF 5045 A	Samples
REF5045AIDG4	ACTIVE	SOIC	D	8	75	Green (RoHS & no Sb/Br)	CU NIPDAU	Level-2-260C-1 YEAR	-40 to 125	REF 5045 A	Samples
REF5045AIDGKR	ACTIVE	VSSOP	DGK	8	2500	Green (RoHS & no Sb/Br)	CU NIPDAU	Level-2-260C-1 YEAR	-40 to 125	R50E	Samples
REF5045AIDGKT	ACTIVE	VSSOP	DGK	8	250	Green (RoHS & no Sb/Br)	CU NIPDAU	Level-2-260C-1 YEAR	-40 to 125	R50E	Samples
REF5045AIDR	ACTIVE	SOIC	D	8	2500	Green (RoHS & no Sb/Br)	CU NIPDAU	Level-2-260C-1 YEAR	-40 to 125	REF 5045 A	Samples
REF5045AIDRG4	ACTIVE	SOIC	D	8	2500	Green (RoHS & no Sb/Br)	CU NIPDAU	Level-2-260C-1 YEAR	-40 to 125	REF 5045 A	Samples
REF5045ID	ACTIVE	SOIC	D	8	75	Green (RoHS & no Sb/Br)	CU NIPDAU	Level-2-260C-1 YEAR	-40 to 125	REF 5045	Samples
REF5045IDGKR	ACTIVE	VSSOP	DGK	8	1	Green (RoHS & no Sb/Br)	CU NIPDAU	Level-2-260C-1 YEAR	-40 to 125	R50E	Samples

Orderable Device	Status (1)	Package Type	Package Drawing	Pins	Package Qty	Eco Plan (2)	Lead/Ball Finish (6)	MSL Peak Temp (3)	Op Temp (°C)	Device Marking (4/5)	Samples
REF5045IDGKT	ACTIVE	VSSOP	DGK	8	250	Green (RoHS & no Sb/Br)	CU NIPDAU	Level-2-260C-1 YEAR	-40 to 125	R50E	Samples
REF5045IDR	ACTIVE	SOIC	D	8	2500	Green (RoHS & no Sb/Br)	CU NIPDAU	Level-2-260C-1 YEAR	-40 to 125	REF 5045	Samples
REF5050AID	ACTIVE	SOIC	D	8	75	Green (RoHS & no Sb/Br)	CU NIPDAU	Level-2-260C-1 YEAR	-40 to 125	REF 5050 A	Samples
REF5050AIDG4	ACTIVE	SOIC	D	8	75	Green (RoHS & no Sb/Br)	CU NIPDAU	Level-2-260C-1 YEAR	-40 to 125	REF 5050 A	Samples
REF5050AIDGKR	ACTIVE	VSSOP	DGK	8	2500	Green (RoHS & no Sb/Br)	CU NIPDAU	Level-2-260C-1 YEAR	-40 to 125	R50F	Samples
REF5050AIDGKT	ACTIVE	VSSOP	DGK	8	250	Green (RoHS & no Sb/Br)	CU NIPDAU	Level-2-260C-1 YEAR	-40 to 125	R50F	Samples
REF5050AIDR	ACTIVE	SOIC	D	8	2500	Green (RoHS & no Sb/Br)	CU NIPDAU	Level-2-260C-1 YEAR	-40 to 125	REF 5050 A	Samples
REF5050ID	ACTIVE	SOIC	D	8	75	Green (RoHS & no Sb/Br)	CU NIPDAU	Level-2-260C-1 YEAR	-40 to 125	REF 5050	Samples
REF5050IDG4	ACTIVE	SOIC	D	8	75	Green (RoHS & no Sb/Br)	CU NIPDAU	Level-2-260C-1 YEAR	-40 to 125	REF 5050	Samples
REF5050IDGKR	ACTIVE	VSSOP	DGK	8	2500	Green (RoHS & no Sb/Br)	CU NIPDAU	Level-2-260C-1 YEAR	-40 to 125	R50F	Samples
REF5050IDGKT	ACTIVE	VSSOP	DGK	8	250	Green (RoHS & no Sb/Br)	CU NIPDAU	Level-2-260C-1 YEAR	-40 to 125	R50F	Samples
REF5050IDR	ACTIVE	SOIC	D	8	2500	Green (RoHS & no Sb/Br)	CU NIPDAU	Level-2-260C-1 YEAR	-40 to 125	REF 5050	Samples
REF5050IDRG4	ACTIVE	SOIC	D	8	2500	Green (RoHS & no Sb/Br)	CU NIPDAU	Level-2-260C-1 YEAR	-40 to 125	REF 5050	Samples

(1) The marketing status values are defined as follows:

ACTIVE: Product device recommended for new designs.

LIFEBUY: TI has announced that the device will be discontinued, and a lifetime-buy period is in effect.

NRND: Not recommended for new designs. Device is in production to support existing customers, but TI does not recommend using this part in a new design.

PREVIEW: Device has been announced but is not in production. Samples may or may not be available.

OBSOLETE: TI has discontinued the production of the device.

(2) Eco Plan - The planned eco-friendly classification: Pb-Free (RoHS), Pb-Free (RoHS Exempt), or Green (RoHS & no Sb/Br) - please check <http://www.ti.com/productcontent> for the latest availability information and additional product content details.

TBD: The Pb-Free/Green conversion plan has not been defined.

Pb-Free (RoHS): TI's terms "Lead-Free" or "Pb-Free" mean semiconductor products that are compatible with the current RoHS requirements for all 6 substances, including the requirement that lead not exceed 0.1% by weight in homogeneous materials. Where designed to be soldered at high temperatures, TI Pb-Free products are suitable for use in specified lead-free processes.

Pb-Free (RoHS Exempt): This component has a RoHS exemption for either 1) lead-based flip-chip solder bumps used between the die and package, or 2) lead-based die adhesive used between the die and leadframe. The component is otherwise considered Pb-Free (RoHS compatible) as defined above.

Green (RoHS & no Sb/Br): TI defines "Green" to mean Pb-Free (RoHS compatible), and free of Bromine (Br) and Antimony (Sb) based flame retardants (Br or Sb do not exceed 0.1% by weight in homogeneous material)

(3) MSL, Peak Temp. - The Moisture Sensitivity Level rating according to the JEDEC industry standard classifications, and peak solder temperature.

(4) There may be additional marking, which relates to the logo, the lot trace code information, or the environmental category on the device.

(5) Multiple Device Markings will be inside parentheses. Only one Device Marking contained in parentheses and separated by a "~" will appear on a device. If a line is indented then it is a continuation of the previous line and the two combined represent the entire Device Marking for that device.

(6) Lead/Ball Finish - Orderable Devices may have multiple material finish options. Finish options are separated by a vertical ruled line. Lead/Ball Finish values may wrap to two lines if the finish value exceeds the maximum column width.

Important Information and Disclaimer: The information provided on this page represents TI's knowledge and belief as of the date that it is provided. TI bases its knowledge and belief on information provided by third parties, and makes no representation or warranty as to the accuracy of such information. Efforts are underway to better integrate information from third parties. TI has taken and continues to take reasonable steps to provide representative and accurate information but may not have conducted destructive testing or chemical analysis on incoming materials and chemicals. TI and TI suppliers consider certain information to be proprietary, and thus CAS numbers and other limited information may not be available for release.

In no event shall TI's liability arising out of such information exceed the total purchase price of the TI part(s) at issue in this document sold by TI to Customer on an annual basis.

OTHER QUALIFIED VERSIONS OF REF5020, REF5025, REF5040, REF5050 :

- Enhanced Product: [REF5020-EP](#), [REF5025-EP](#), [REF5040-EP](#), [REF5050-EP](#)

NOTE: Qualified Version Definitions:

- Enhanced Product - Supports Defense, Aerospace and Medical Applications

TAPE AND REEL INFORMATION



QUADRANT ASSIGNMENTS FOR PIN 1 ORIENTATION IN TAPE



*All dimensions are nominal

Device	Package Type	Package Drawing	Pins	SPQ	Reel Diameter (mm)	Reel Width W1 (mm)	A0 (mm)	B0 (mm)	K0 (mm)	P1 (mm)	W (mm)	Pin1 Quadrant
REF5010AIDGKR	VSSOP	DGK	8	2500	330.0	12.4	5.3	3.4	1.4	8.0	12.0	Q1
REF5010AIDGKT	VSSOP	DGK	8	250	180.0	12.4	5.3	3.4	1.4	8.0	12.0	Q1
REF5010AIDR	SOIC	D	8	2500	330.0	12.4	6.4	5.2	2.1	8.0	12.0	Q1
REF5010IDGKR	VSSOP	DGK	8	2500	330.0	12.4	5.3	3.4	1.4	8.0	12.0	Q1
REF5010IDGKT	VSSOP	DGK	8	250	180.0	12.4	5.3	3.4	1.4	8.0	12.0	Q1
REF5020AIDGKR	VSSOP	DGK	8	2500	330.0	12.4	5.3	3.4	1.4	8.0	12.0	Q1
REF5020AIDGKT	VSSOP	DGK	8	250	180.0	12.4	5.3	3.4	1.4	8.0	12.0	Q1
REF5020AIDR	SOIC	D	8	2500	330.0	12.4	6.4	5.2	2.1	8.0	12.0	Q1
REF5020IDGKR	VSSOP	DGK	8	2500	330.0	12.4	5.3	3.4	1.4	8.0	12.0	Q1
REF5020IDGKT	VSSOP	DGK	8	250	180.0	12.4	5.3	3.4	1.4	8.0	12.0	Q1
REF5020IDR	SOIC	D	8	2500	330.0	12.4	6.4	5.2	2.1	8.0	12.0	Q1
REF5025AIDGKR	VSSOP	DGK	8	2500	330.0	12.4	5.3	3.4	1.4	8.0	12.0	Q1
REF5025AIDGKT	VSSOP	DGK	8	250	180.0	12.4	5.3	3.4	1.4	8.0	12.0	Q1
REF5025AIDR	SOIC	D	8	2500	330.0	12.4	6.4	5.2	2.1	8.0	12.0	Q1
REF5025IDGKR	VSSOP	DGK	8	2500	330.0	12.4	5.3	3.4	1.4	8.0	12.0	Q1
REF5025IDGKT	VSSOP	DGK	8	250	180.0	12.4	5.3	3.4	1.4	8.0	12.0	Q1
REF5025IDR	SOIC	D	8	2500	330.0	12.4	6.4	5.2	2.1	8.0	12.0	Q1
REF5030AIDGKR	VSSOP	DGK	8	2500	330.0	12.4	5.3	3.4	1.4	8.0	12.0	Q1

Device	Package Type	Package Drawing	Pins	SPQ	Reel Diameter (mm)	Reel Width W1 (mm)	A0 (mm)	B0 (mm)	K0 (mm)	P1 (mm)	W (mm)	Pin1 Quadrant
REF5030AIDGKT	VSSOP	DGK	8	250	180.0	12.4	5.3	3.4	1.4	8.0	12.0	Q1
REF5030AIDR	SOIC	D	8	2500	330.0	12.4	6.4	5.2	2.1	8.0	12.0	Q1
REF5030IDGKR	VSSOP	DGK	8	2500	330.0	12.4	5.3	3.4	1.4	8.0	12.0	Q1
REF5030IDGKT	VSSOP	DGK	8	250	180.0	12.4	5.3	3.4	1.4	8.0	12.0	Q1
REF5030IDR	SOIC	D	8	2500	330.0	12.4	6.4	5.2	2.1	8.0	12.0	Q1
REF5040AIDGKR	VSSOP	DGK	8	2500	330.0	12.4	5.3	3.4	1.4	8.0	12.0	Q1
REF5040AIDGKT	VSSOP	DGK	8	250	180.0	12.4	5.3	3.4	1.4	8.0	12.0	Q1
REF5040AIDR	SOIC	D	8	2500	330.0	12.4	6.4	5.2	2.1	8.0	12.0	Q1
REF5040IDGKR	VSSOP	DGK	8	2500	330.0	12.4	5.3	3.4	1.4	8.0	12.0	Q1
REF5040IDGKT	VSSOP	DGK	8	250	180.0	12.4	5.3	3.4	1.4	8.0	12.0	Q1
REF5040IDR	SOIC	D	8	2500	330.0	12.4	6.4	5.2	2.1	8.0	12.0	Q1
REF5045AIDGKR	VSSOP	DGK	8	2500	330.0	12.4	5.3	3.4	1.4	8.0	12.0	Q1
REF5045AIDGKT	VSSOP	DGK	8	250	180.0	12.4	5.3	3.4	1.4	8.0	12.0	Q1
REF5045AIDR	SOIC	D	8	2500	330.0	12.4	6.4	5.2	2.1	8.0	12.0	Q1
REF5045IDGKR	VSSOP	DGK	8	1	330.0	12.4	5.3	3.4	1.4	8.0	12.0	Q1
REF5045IDGKT	VSSOP	DGK	8	250	180.0	12.4	5.3	3.4	1.4	8.0	12.0	Q1
REF5045IDR	SOIC	D	8	2500	330.0	12.4	6.4	5.2	2.1	8.0	12.0	Q1
REF5050AIDGKR	VSSOP	DGK	8	2500	330.0	12.4	5.3	3.4	1.4	8.0	12.0	Q1
REF5050AIDGKT	VSSOP	DGK	8	250	180.0	12.4	5.3	3.4	1.4	8.0	12.0	Q1
REF5050AIDR	SOIC	D	8	2500	330.0	12.4	6.4	5.2	2.1	8.0	12.0	Q1
REF5050IDGKR	VSSOP	DGK	8	2500	330.0	12.4	5.3	3.4	1.4	8.0	12.0	Q1
REF5050IDGKT	VSSOP	DGK	8	250	180.0	12.4	5.3	3.4	1.4	8.0	12.0	Q1
REF5050IDR	SOIC	D	8	2500	330.0	12.4	6.4	5.2	2.1	8.0	12.0	Q1

TAPE AND REEL BOX DIMENSIONS

*All dimensions are nominal

Device	Package Type	Package Drawing	Pins	SPQ	Length (mm)	Width (mm)	Height (mm)
REF5010AIDGKR	VSSOP	DGK	8	2500	367.0	367.0	35.0
REF5010AIDGKT	VSSOP	DGK	8	250	210.0	185.0	35.0
REF5010AIDR	SOIC	D	8	2500	367.0	367.0	35.0
REF5010IDGKR	VSSOP	DGK	8	2500	367.0	367.0	35.0
REF5010IDGKT	VSSOP	DGK	8	250	210.0	185.0	35.0
REF5020AIDGKR	VSSOP	DGK	8	2500	367.0	367.0	35.0
REF5020AIDGKT	VSSOP	DGK	8	250	210.0	185.0	35.0
REF5020AIDR	SOIC	D	8	2500	367.0	367.0	35.0
REF5020IDGKR	VSSOP	DGK	8	2500	367.0	367.0	35.0
REF5020IDGKT	VSSOP	DGK	8	250	210.0	185.0	35.0
REF5020IDR	SOIC	D	8	2500	367.0	367.0	35.0
REF5025AIDGKR	VSSOP	DGK	8	2500	367.0	367.0	35.0
REF5025AIDGKT	VSSOP	DGK	8	250	210.0	185.0	35.0
REF5025AIDR	SOIC	D	8	2500	367.0	367.0	35.0
REF5025IDGKR	VSSOP	DGK	8	2500	367.0	367.0	35.0
REF5025IDGKT	VSSOP	DGK	8	250	210.0	185.0	35.0
REF5025IDR	SOIC	D	8	2500	367.0	367.0	35.0
REF5030AIDGKR	VSSOP	DGK	8	2500	367.0	367.0	35.0
REF5030AIDGKT	VSSOP	DGK	8	250	210.0	185.0	35.0
REF5030AIDR	SOIC	D	8	2500	367.0	367.0	35.0

Device	Package Type	Package Drawing	Pins	SPQ	Length (mm)	Width (mm)	Height (mm)
REF5030IDGKR	VSSOP	DGK	8	2500	367.0	367.0	35.0
REF5030IDGKT	VSSOP	DGK	8	250	210.0	185.0	35.0
REF5030IDR	SOIC	D	8	2500	367.0	367.0	35.0
REF5040AIDGKR	VSSOP	DGK	8	2500	367.0	367.0	35.0
REF5040AIDGKT	VSSOP	DGK	8	250	210.0	185.0	35.0
REF5040AIDR	SOIC	D	8	2500	367.0	367.0	35.0
REF5040IDGKR	VSSOP	DGK	8	2500	367.0	367.0	35.0
REF5040IDGKT	VSSOP	DGK	8	250	210.0	185.0	35.0
REF5040IDR	SOIC	D	8	2500	367.0	367.0	35.0
REF5045AIDGKR	VSSOP	DGK	8	2500	367.0	367.0	35.0
REF5045AIDGKT	VSSOP	DGK	8	250	210.0	185.0	35.0
REF5045AIDR	SOIC	D	8	2500	367.0	367.0	35.0
REF5045IDGKR	VSSOP	DGK	8	1	367.0	367.0	35.0
REF5045IDGKT	VSSOP	DGK	8	250	210.0	185.0	35.0
REF5045IDR	SOIC	D	8	2500	367.0	367.0	35.0
REF5050AIDGKR	VSSOP	DGK	8	2500	367.0	367.0	35.0
REF5050AIDGKT	VSSOP	DGK	8	250	210.0	185.0	35.0
REF5050AIDR	SOIC	D	8	2500	367.0	367.0	35.0
REF5050IDGKR	VSSOP	DGK	8	2500	367.0	367.0	35.0
REF5050IDGKT	VSSOP	DGK	8	250	210.0	185.0	35.0
REF5050IDR	SOIC	D	8	2500	367.0	367.0	35.0

D (R-PDSO-G8)

PLASTIC SMALL OUTLINE



- NOTES:
- A. All linear dimensions are in inches (millimeters).
 - B. This drawing is subject to change without notice.
 - C. Body length does not include mold flash, protrusions, or gate burrs. Mold flash, protrusions, or gate burrs shall not exceed 0.006 (0,15) each side.
 - D. Body width does not include interlead flash. Interlead flash shall not exceed 0.017 (0,43) each side.
 - E. Reference JEDEC MS-012 variation AA.

D (R-PDSO-G8)

PLASTIC SMALL OUTLINE



- NOTES:
- All linear dimensions are in millimeters.
 - This drawing is subject to change without notice.
 - Publication IPC-7351 is recommended for alternate designs.
 - Laser cutting apertures with trapezoidal walls and also rounding corners will offer better paste release. Customers should contact their board assembly site for stencil design recommendations. Refer to IPC-7525 for other stencil recommendations.
 - Customers should contact their board fabrication site for solder mask tolerances between and around signal pads.



- NOTES:
- A. All linear dimensions are in millimeters.
 - B. This drawing is subject to change without notice.
 - C. Publication IPC-7351 is recommended for alternate designs.
 - D. Laser cutting apertures with trapezoidal walls and also rounding corners will offer better paste release. Customers should contact their board assembly site for stencil design recommendations. Refer to IPC-7525 for other stencil recommendations.
 - E. Customers should contact their board fabrication site for solder mask tolerances between and around signal pads.

IMPORTANT NOTICE

Texas Instruments Incorporated (TI) reserves the right to make corrections, enhancements, improvements and other changes to its semiconductor products and services per JESD46, latest issue, and to discontinue any product or service per JESD48, latest issue. Buyers should obtain the latest relevant information before placing orders and should verify that such information is current and complete.

TI's published terms of sale for semiconductor products (<http://www.ti.com/sc/docs/stdterms.htm>) apply to the sale of packaged integrated circuit products that TI has qualified and released to market. Additional terms may apply to the use or sale of other types of TI products and services.

Reproduction of significant portions of TI information in TI data sheets is permissible only if reproduction is without alteration and is accompanied by all associated warranties, conditions, limitations, and notices. TI is not responsible or liable for such reproduced documentation. Information of third parties may be subject to additional restrictions. Resale of TI products or services with statements different from or beyond the parameters stated by TI for that product or service voids all express and any implied warranties for the associated TI product or service and is an unfair and deceptive business practice. TI is not responsible or liable for any such statements.

Buyers and others who are developing systems that incorporate TI products (collectively, "Designers") understand and agree that Designers remain responsible for using their independent analysis, evaluation and judgment in designing their applications and that Designers have full and exclusive responsibility to assure the safety of Designers' applications and compliance of their applications (and of all TI products used in or for Designers' applications) with all applicable regulations, laws and other applicable requirements. Designer represents that, with respect to their applications, Designer has all the necessary expertise to create and implement safeguards that (1) anticipate dangerous consequences of failures, (2) monitor failures and their consequences, and (3) lessen the likelihood of failures that might cause harm and take appropriate actions. Designer agrees that prior to using or distributing any applications that include TI products, Designer will thoroughly test such applications and the functionality of such TI products as used in such applications.

TI's provision of technical, application or other design advice, quality characterization, reliability data or other services or information, including, but not limited to, reference designs and materials relating to evaluation modules, (collectively, "TI Resources") are intended to assist designers who are developing applications that incorporate TI products; by downloading, accessing or using TI Resources in any way, Designer (individually or, if Designer is acting on behalf of a company, Designer's company) agrees to use any particular TI Resource solely for this purpose and subject to the terms of this Notice.

TI's provision of TI Resources does not expand or otherwise alter TI's applicable published warranties or warranty disclaimers for TI products, and no additional obligations or liabilities arise from TI providing such TI Resources. TI reserves the right to make corrections, enhancements, improvements and other changes to its TI Resources. TI has not conducted any testing other than that specifically described in the published documentation for a particular TI Resource.

Designer is authorized to use, copy and modify any individual TI Resource only in connection with the development of applications that include the TI product(s) identified in such TI Resource. NO OTHER LICENSE, EXPRESS OR IMPLIED, BY ESTOPPEL OR OTHERWISE TO ANY OTHER TI INTELLECTUAL PROPERTY RIGHT, AND NO LICENSE TO ANY TECHNOLOGY OR INTELLECTUAL PROPERTY RIGHT OF TI OR ANY THIRD PARTY IS GRANTED HEREIN, including but not limited to any patent right, copyright, mask work right, or other intellectual property right relating to any combination, machine, or process in which TI products or services are used. Information regarding or referencing third-party products or services does not constitute a license to use such products or services, or a warranty or endorsement thereof. Use of TI Resources may require a license from a third party under the patents or other intellectual property of the third party, or a license from TI under the patents or other intellectual property of TI.

TI RESOURCES ARE PROVIDED "AS IS" AND WITH ALL FAULTS. TI DISCLAIMS ALL OTHER WARRANTIES OR REPRESENTATIONS, EXPRESS OR IMPLIED, REGARDING RESOURCES OR USE THEREOF, INCLUDING BUT NOT LIMITED TO ACCURACY OR COMPLETENESS, TITLE, ANY EPIDEMIC FAILURE WARRANTY AND ANY IMPLIED WARRANTIES OF MERCHANTABILITY, FITNESS FOR A PARTICULAR PURPOSE, AND NON-INFRINGEMENT OF ANY THIRD PARTY INTELLECTUAL PROPERTY RIGHTS. TI SHALL NOT BE LIABLE FOR AND SHALL NOT DEFEND OR INDEMNIFY DESIGNER AGAINST ANY CLAIM, INCLUDING BUT NOT LIMITED TO ANY INFRINGEMENT CLAIM THAT RELATES TO OR IS BASED ON ANY COMBINATION OF PRODUCTS EVEN IF DESCRIBED IN TI RESOURCES OR OTHERWISE. IN NO EVENT SHALL TI BE LIABLE FOR ANY ACTUAL, DIRECT, SPECIAL, COLLATERAL, INDIRECT, PUNITIVE, INCIDENTAL, CONSEQUENTIAL OR EXEMPLARY DAMAGES IN CONNECTION WITH OR ARISING OUT OF TI RESOURCES OR USE THEREOF, AND REGARDLESS OF WHETHER TI HAS BEEN ADVISED OF THE POSSIBILITY OF SUCH DAMAGES.

Unless TI has explicitly designated an individual product as meeting the requirements of a particular industry standard (e.g., ISO/TS 16949 and ISO 26262), TI is not responsible for any failure to meet such industry standard requirements.

Where TI specifically promotes products as facilitating functional safety or as compliant with industry functional safety standards, such products are intended to help enable customers to design and create their own applications that meet applicable functional safety standards and requirements. Using products in an application does not by itself establish any safety features in the application. Designers must ensure compliance with safety-related requirements and standards applicable to their applications. Designer may not use any TI products in life-critical medical equipment unless authorized officers of the parties have executed a special contract specifically governing such use. Life-critical medical equipment is medical equipment where failure of such equipment would cause serious bodily injury or death (e.g., life support, pacemakers, defibrillators, heart pumps, neurostimulators, and implantables). Such equipment includes, without limitation, all medical devices identified by the U.S. Food and Drug Administration as Class III devices and equivalent classifications outside the U.S.

TI may expressly designate certain products as completing a particular qualification (e.g., Q100, Military Grade, or Enhanced Product). Designers agree that it has the necessary expertise to select the product with the appropriate qualification designation for their applications and that proper product selection is at Designers' own risk. Designers are solely responsible for compliance with all legal and regulatory requirements in connection with such selection.

Designer will fully indemnify TI and its representatives against any damages, costs, losses, and/or liabilities arising out of Designer's non-compliance with the terms and provisions of this Notice.