

LMV831 Single / LMV832 Dual / LMV834 Quad 3.3-MHz Low-Power CMOS, EMI-Hardened Operational Amplifiers

1 Features

- Unless Otherwise Noted, Typical Values at $T_A = 25^\circ\text{C}$, $V^+ = 3.3\text{ V}$
- Supply Voltage 2.7 V to 5.5 V
- Supply Current (per Channel) 240 μA
- Input Offset Voltage 1-mV Maximum
- Input Bias Current 0.1 pA
- GBW 3.3 MHz
- EMIRR at 1.8 GHz 120 dB
- Input Noise Voltage at 1 kHz 12 $\text{nV}/\sqrt{\text{Hz}}$
- Slew Rate 2 $\text{V}/\mu\text{s}$
- Output Voltage Swing Rail-to-Rail
- Output Current Drive 30 mA
- Operating Ambient Temperature Range -40°C to 125°C

2 Applications

- Photodiode Preamps
- Piezoelectric Sensors
- Portable/Battery-Powered Electronic Equipment
- Filters and Buffers
- PDAs and Phone Accessories

3 Description

TI's LMV83x devices are CMOS input, low-power operation amplifier ICs, providing a low input bias current, a wide temperature range of -40°C to 125°C , and exceptional performance, making them robust general-purpose parts. Additionally, the LMV83x are EMI-hardened to minimize any interference, making them ideal for EMI-sensitive applications.

The unity gain stable LMV83x feature 3.3-MHz of bandwidth while consuming only 0.24 mA of current per channel. These parts also maintain stability for capacitive loads as large as 200 pF. The LMV83x provide superior performance and economy in terms of power and space usage.

This family of parts has a maximum input offset voltage of 1 mV, a rail-to-rail output stage and an input common-mode voltage range that includes ground. Over an operating range from 2.7 V to 5.5 V, the LMV83x provide a PSRR of 93 dB, and a CMRR of 91 dB. The LMV831 is offered in the space-saving 5-pin SC70 package, the LMV832 in the 8-pin VSSOP and the LMV834 is offered in the 14-pin TSSOP package.

Device Information⁽¹⁾

PART NUMBER	PACKAGE	BODY SIZE (NOM)
LMV831	SC70 (5)	1.25 mm x 2.00 mm
LMV832	VSSOP (8)	3.00 mm x 3.00 mm
LMV834	TSSOP (14)	4.40 mm x 5.00 mm

(1) For all available packages, see the orderable addendum at the end of the data sheet.

Typical Application

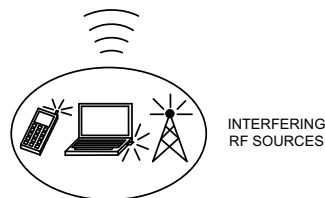
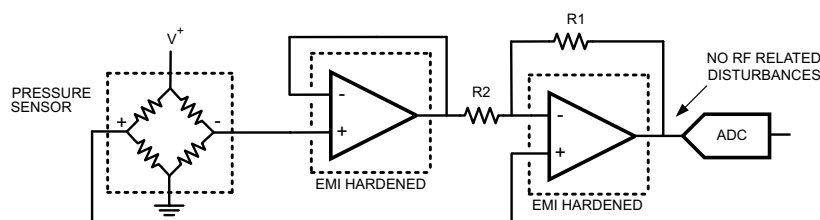

Table of Contents

1 Features	1	7.4 Device Functional Modes.....	20
2 Applications	1	8 Application and Implementation	22
3 Description	1	8.1 Application Information.....	22
4 Revision History	2	8.2 Typical Application	22
5 Pin Configuration and Functions	3	9 Power Supply Recommendations	24
6 Specifications	4	10 Layout	25
6.1 Absolute Maximum Ratings	4	10.1 Layout Guidelines	25
6.2 ESD Ratings.....	4	10.2 Layout Example	25
6.3 Recommended Operating Conditions.....	4	11 Device and Documentation Support	26
6.4 Thermal Information	4	11.1 Device Support	26
6.5 Electrical Characteristics, 3.3 V	5	11.2 Documentation Support	26
6.6 Electrical Characteristics, 5 V	7	11.3 Related Links	26
6.7 Typical Characteristics	10	11.4 Community Resources.....	26
7 Detailed Description	17	11.5 Trademarks	26
7.1 Overview	17	11.6 Electrostatic Discharge Caution.....	27
7.2 Functional Block Diagram	17	11.7 Glossary	27
7.3 Feature Description.....	17	12 Mechanical, Packaging, and Orderable Information	27

4 Revision History

NOTE: Page numbers for previous revisions may differ from page numbers in the current version.

Changes from Revision B (March 2013) to Revision C	Page
<ul style="list-style-type: none"> Added <i>ESD Ratings</i> table, <i>Feature Description</i> section, <i>Device Functional Modes</i>, <i>Application and Implementation</i> section, <i>Power Supply Recommendations</i> section, <i>Layout</i> section, <i>Device and Documentation Support</i> section, and <i>Mechanical, Packaging, and Orderable Information</i> section. 	1

Changes from Revision A (March 2013) to Revision B	Page
<ul style="list-style-type: none"> Changed layout of National Data Sheet to TI format 	23

5 Pin Configuration and Functions

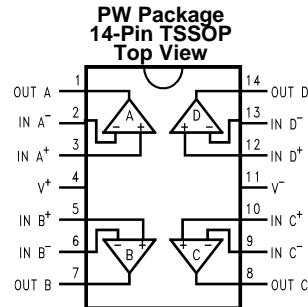
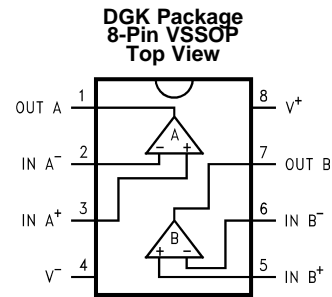
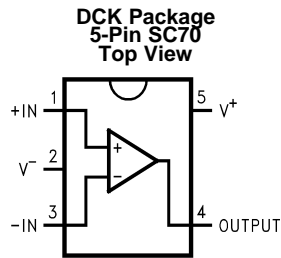

Pin Functions

NAME	PIN			TYPE	DESCRIPTION
	SC70	VSSOP	TSSOP		
IN+	1	—	—	I	Noninverting Input
IN-	3	—	—	I	Inverting Input
IN A+	—	3	3	I	Noninverting Input, Channel A
IN A-	—	2	2	I	Inverting Input, Channel A
IN B+	—	5	5	I	Noninverting Input, Channel B
IN B-	—	6	6	I	Inverting Input, Channel B
IN C+	—	—	10	I	Noninverting Input, Channel C
IN C-	—	—	9	I	Inverting Input, Channel C
IN D+	—	—	12	I	Noninverting Input, Channel D
IN D-	—	—	13	I	Inverting Input, Channel D
OUT A	—	1	1	O	Output, Channel A
OUT B	—	7	7	O	Output, Channel B
OUT C	—	—	8	O	Output, Channel C
OUT D	—	—	14	O	Output, Channel D
OUTPUT	4	—	—	O	Output
V+	5	8	4	P	Positive (highest) Power Supply
V-	2	4	11	P	Negative (lowest) Power Supply

6 Specifications

6.1 Absolute Maximum Ratings

 See ⁽¹⁾⁽²⁾

	MIN	MAX	UNIT
V _{IN} differential	±Supply Voltage		V
Supply voltage (V _S = V ⁺ – V ⁻)	6		V
Voltage at input/output pins	V ⁻ – 0.4	V ⁺ + 0.4	V
Junction temperature ⁽³⁾	150		°C
Soldering information Infrared or Convection (20 sec)	260		°C
Storage temperature, T _{stg}	-65	150	°C

- (1) Stresses beyond those listed under *Absolute Maximum Ratings* may cause permanent damage to the device. These are stress ratings only, which do not imply functional operation of the device at these or any other conditions beyond those indicated under *Recommended Operating Conditions*. Exposure to absolute-maximum-rated conditions for extended periods may affect device reliability.
- (2) If Military/Aerospace specified devices are required, please contact the Texas Instruments Sales Office/ Distributors for availability and specifications.
- (3) The maximum power dissipation is a function of T_{J(MAX)}, R_{θJA}, and T_A. The maximum allowable power dissipation at any ambient temperature is P_D = (T_{J(MAX)} – T_A) / R_{θJA}. All numbers apply for packages soldered directly onto a PCB.

6.2 ESD Ratings

		VALUE	UNIT
V _(ESD) Electrostatic discharge ⁽¹⁾	Human body model (HBM), per ANSI/ESDA/JEDEC JS-001	±2000	V
	Charged-device model (CDM), per JEDEC specification JESD22-C101	±1000	
	Machine Model (MM)	±200	

- (1) Human Body Model, applicable std. MIL-STD-883, Method 3015.7. Machine Model, applicable std. JESD22-A115-A (ESD MM std. of JEDEC) Field-Induced Charge-Device Model, applicable std. JESD22-C101-C (ESD FICDM std. of JEDEC).

6.3 Recommended Operating Conditions

	MIN	MAX	UNIT
Temperature range ⁽¹⁾	-40	125	°C
Supply voltage (V _S = V ⁺ – V ⁻)	2.7	5.5	V

- (1) The maximum power dissipation is a function of T_{J(MAX)}, θ_{JA}, and T_A. The maximum allowable power dissipation at any ambient temperature is P_D = (T_{J(MAX)} – T_A) / θ_{JA}. All numbers apply for packages soldered directly onto a PCB.

6.4 Thermal Information

THERMAL METRIC ⁽¹⁾		LMV831	LMV832	LMV834	UNIT
		DCK (SC70)	DGK (VSSOP)	PW (TSSOP)	
		5 PINS	8 PINS	14 PINS	
R _{θJA}	Junction-to-ambient thermal resistance ⁽²⁾	267.7	177.1	118.2	°C/W
R _{θJC(top)}	Junction-to-case (top) thermal resistance	96.6	67.1	44.4	°C/W
R _{θJB}	Junction-to-board thermal resistance	48.8	97.5	60.5	°C/W
ψ _{JT}	Junction-to-top characterization parameter	2.5	9.9	4.5	°C/W
ψ _{JB}	Junction-to-board characterization parameter	47.9	96.1	59.9	°C/W

- (1) For more information about traditional and new thermal metrics, see the *Semiconductor and IC Package Thermal Metrics* application report, [SPRA953](#).
- (2) The maximum power dissipation is a function of T_{J(MAX)}, R_{θJA}, and T_A. The maximum allowable power dissipation at any ambient temperature is P_D = (T_{J(MAX)} – T_A) / R_{θJA}. All numbers apply for packages soldered directly onto a PCB.

6.5 Electrical Characteristics, 3.3 V

Unless otherwise specified, all limits are specified for at $T_A = 25^\circ\text{C}$, $V^+ = 3.3\text{ V}$, $V^- = 0\text{ V}$, $V_{\text{CM}} = V^+/2$, and $R_L = 10\text{ k}\Omega$ to $V^+/2$.⁽¹⁾

PARAMETER		TEST CONDITIONS		MIN ⁽²⁾	TYP ⁽³⁾	MAX ⁽²⁾	UNIT
V_{OS}	Input offset voltage ⁽⁴⁾	$T_A = 25^\circ\text{C}$			± 0.25	± 1	mV
		$-40^\circ\text{C} \leq T_A \leq +125^\circ\text{C}$				± 1.23	
TCV_{OS}	Input offset voltage temperature drift ⁽⁴⁾⁽⁵⁾	LMV831, LMV832			± 0.5	± 1.5	$\mu\text{V}/^\circ\text{C}$
		LMV834			± 0.5	± 1.7	
I_{B}	Input bias current ⁽⁵⁾	$T_A = 25^\circ\text{C}$			0.1	10	μA
		$-40^\circ\text{C} \leq T_A \leq +125^\circ\text{C}$				500	
I_{OS}	Input offset current				1		μA
CMRR	Common-mode rejection ratio ⁽⁴⁾	$0.2\text{ V} \leq V_{\text{CM}} \leq V^+ - 1.2\text{ V}$	$T_A = 25^\circ\text{C}$	76	91		dB
			$-40^\circ\text{C} \leq T_A \leq +125^\circ\text{C}$	75			
PSRR	Power supply rejection ratio ⁽⁴⁾	$2.7\text{ V} \leq V^+ \leq 5.5\text{ V}$, $V_{\text{OUT}} = 1\text{ V}$	$T_A = 25^\circ\text{C}$	76	93		dB
			$-40^\circ\text{C} \leq T_A \leq +125^\circ\text{C}$	75			
EMIRR	EMI rejection ratio, IN+ and IN- ⁽⁶⁾	$V_{\text{RF_PEAK}} = 100\text{ mV}_\text{P}$ (-20 dB_P), $f = 400\text{ MHz}$			80		dB
		$V_{\text{RF_PEAK}} = 100\text{ mV}_\text{P}$ (-20 dB_P), $f = 900\text{ MHz}$			90		
		$V_{\text{RF_PEAK}} = 100\text{ mV}_\text{P}$ (-20 dB_P), $f = 1800\text{ MHz}$			110		
		$V_{\text{RF_PEAK}} = 100\text{ mV}_\text{P}$ (-20 dB_P), $f = 2400\text{ MHz}$			120		
CMVR	Input common-mode voltage range	$\text{CMRR} \geq 65\text{ dB}$		-0.1		2.1	V
A_{VOL}	Large signal voltage gain ⁽⁷⁾	$R_L = 2\text{ k}\Omega$, $V_{\text{OUT}} = 0.15\text{ V to } 1.65\text{ V}$, $V_{\text{OUT}} = 3.15\text{ V to } 1.65\text{ V}$	LMV831, LMV832	102	121		dB
			LMV831, LMV832, $-40^\circ\text{C} \leq T_A \leq +125^\circ\text{C}$	102			
			LMV834	102	121		
			LMV834 $-40^\circ\text{C} \leq T_A \leq +125^\circ\text{C}$	102			
		$R_L = 10\text{ k}\Omega$, $V_{\text{OUT}} = 0.1\text{ V to } 1.65\text{ V}$, $V_{\text{OUT}} = 3.2\text{ V to } 1.65\text{ V}$	LMV831, LMV832	104	126		
			LMV831, LMV832, $-40^\circ\text{C} \leq T_A \leq +125^\circ\text{C}$	104			
			LMV834	104	123		
			LMV834 $-40^\circ\text{C} \leq T_A \leq +125^\circ\text{C}$	103			

- (1) Electrical Table values apply only for factory testing conditions at the temperature indicated. Factory testing conditions result in very limited self-heating of the device such that $T_J = T_A$. No specification of parametric performance is indicated in the electrical tables under conditions of internal self-heating where $T_J > T_A$.
- (2) Limits are 100% production tested at 25°C . Limits over the operating temperature range are specified through correlations using statistical quality control (SQC) method.
- (3) Typical values represent the most likely parametric norm as determined at the time of characterization. Actual typical values may vary over time and will also depend on the application and configuration. The typical values are not tested and are not ensured on shipped production material.
- (4) The typical value is calculated by applying absolute value transform to the distribution, then taking the statistical average of the resulting distribution.
- (5) This parameter is specified by design and/or characterization and is not tested in production.
- (6) The EMI Rejection Ratio is defined as $\text{EMIRR} = 20\log (V_{\text{RF_PEAK}}/\Delta V_{\text{OS}})$.
- (7) The specified limits represent the lower of the measured values for each output range condition.

Electrical Characteristics, 3.3 V (continued)

Unless otherwise specified, all limits are specified for at $T_A = 25^\circ\text{C}$, $V^+ = 3.3\text{ V}$, $V^- = 0\text{ V}$, $V_{CM} = V^+/2$, and $R_L = 10\text{ k}\Omega$ to $V^+/2$.⁽¹⁾

PARAMETER		TEST CONDITIONS		MIN ⁽²⁾	TYP ⁽³⁾	MAX ⁽²⁾	UNIT
V_{OUT}	Output voltage swing high	$R_L = 2\text{ k}\Omega$ to $V^+/2$	LMV831, LMV832		29	36	mV from either rail
			LMV831, LMV832, $-40^\circ\text{C} \leq T_A \leq +125^\circ\text{C}$			43	
			LMV834		31	38	
		LMV834 $-40^\circ\text{C} \leq T_A \leq +125^\circ\text{C}$			44		
		$R_L = 10\text{ k}\Omega$ to $V^+/2$	LMV831, LMV832		6	8	
			LMV831, LMV832, $-40^\circ\text{C} \leq T_A \leq +125^\circ\text{C}$			9	
	LMV834			7	9		
	Output voltage swing low	$R = 2\text{ k}\Omega$ to $V^+/2$	$T_A = 25^\circ\text{C}$		25	34	
			$-40^\circ\text{C} \leq T_A \leq +125^\circ\text{C}$			43	
		$R_L = 10\text{ k}\Omega$ to $V^+/2$	$T_A = 25^\circ\text{C}$		5	8	
$-40^\circ\text{C} \leq T_A \leq +125^\circ\text{C}$					10		
I_{OUT}	Output short circuit current	Sourcing, $V_{OUT} = V_{CM}$, $V_{IN} = 100\text{ mV}$	LMV831, LMV832	27	28	mA	
			LMV831, LMV832, $-40^\circ\text{C} \leq T_A \leq +125^\circ\text{C}$	22			
			LMV834	24	28		
			LMV834 $-40^\circ\text{C} \leq T_A \leq +125^\circ\text{C}$	19			
		Sinking, $V_{OUT} = V_{CM}$, $V_{IN} = -100\text{ mV}$	$T_A = 25^\circ\text{C}$	27	32		
			$-40^\circ\text{C} \leq T_A \leq +125^\circ\text{C}$	21			
I_S	Supply current	LMV831		0.24	0.27	mA	
		LMV831, $-40^\circ\text{C} \leq T_A \leq +125^\circ\text{C}$			0.3		
		LMV832		0.46	0.51		
		LMV832, $-40^\circ\text{C} \leq T_A \leq +125^\circ\text{C}$			0.58		
		LMV834		0.9	1		
		LMV834, $-40^\circ\text{C} \leq T_A \leq +125^\circ\text{C}$			1.16		
SR	Slew rate ⁽⁸⁾	$A_V = +1$, $V_{OUT} = 1\text{ V}_{PP}$, 10% to 90%		2		V/ μs	
GBW	Gain bandwidth product			3.3		MHz	
Φ_m	Phase margin			65		deg	
e_n	Input referred voltage noise	$f = 1\text{ kHz}$		12		nV/ $\sqrt{\text{Hz}}$	
		$f = 10\text{ kHz}$		10			
i_n	Input referred current noise	$f = 1\text{ kHz}$		0.005		pA/ $\sqrt{\text{Hz}}$	
R_{OUT}	Closed-loop output impedance	$f = 2\text{ MHz}$		500		Ω	

(8) Number specified is the slower of positive and negative slew rates.

Electrical Characteristics, 3.3 V (continued)

Unless otherwise specified, all limits are specified for at $T_A = 25^\circ\text{C}$, $V^+ = 3.3\text{ V}$, $V^- = 0\text{ V}$, $V_{CM} = V^+/2$, and $R_L = 10\text{ k}\Omega$ to $V^+/2$.⁽¹⁾

PARAMETER		TEST CONDITIONS	MIN ⁽²⁾	TYP ⁽³⁾	MAX ⁽²⁾	UNIT
C_{IN}	Common-mode input capacitance			15		pF
	Differential-mode input capacitance			20		
THD+N	Total harmonic distortion + noise	$f = 1\text{ kHz}$, $A_V = 1$, $BW \geq 500\text{ kHz}$		0.02%		

6.6 Electrical Characteristics, 5 V

Unless otherwise specified, all limits are specified for at $T_A = 25^\circ\text{C}$, $V^+ = 5\text{ V}$, $V^- = 0\text{ V}$, $V_{CM} = V^+/2$, and $R_L = 10\text{ k}\Omega$ to $V^+/2$.⁽¹⁾

PARAMETER		TEST CONDITIONS	MIN ⁽²⁾	TYP ⁽³⁾	MAX ⁽²⁾	UNIT	
V_{OS}	Input offset voltage ⁽⁴⁾	$T_A = 25^\circ\text{C}$		± 0.25	± 1	mV	
		$-40^\circ\text{C} \leq T_A \leq +125^\circ\text{C}$			± 1.23		
TCV_{OS}	Input offset voltage temperature drift ⁽⁴⁾⁽⁵⁾	LMV831, LMV832		± 0.5	± 1.5	$\mu\text{V}/^\circ\text{C}$	
		LMV834		± 0.5	± 1.7		
I_B	Input bias current ⁽⁵⁾	$T_A = 25^\circ\text{C}$		0.1	10	pA	
		$-40^\circ\text{C} \leq T_A \leq +125^\circ\text{C}$			500		
I_{OS}	Input offset current			1		pA	
CMRR	Common-mode rejection ratio ⁽⁴⁾	$0\text{ V} \leq V_{CM} \leq V^+ - 1.2\text{ V}$	$T_A = 25^\circ\text{C}$	77	93	dB	
			$-40^\circ\text{C} \leq T_A \leq +125^\circ\text{C}$	77			
PSRR	Power supply rejection ratio ⁽⁴⁾	$2.7\text{ V} \leq V^+ \leq 5.5\text{ V}$, $V_{OUT} = 1\text{ V}$	$T_A = 25^\circ\text{C}$	76	93	dB	
			$-40^\circ\text{C} \leq T_A \leq +125^\circ\text{C}$	75			
EMIRR	EMI rejection ratio, IN+ and IN ⁻ ⁽⁶⁾	$V_{RF_PEAK} = 100\text{ mV}_P$ (-20 dB_P), $f = 400\text{ MHz}$		80		dB	
			$V_{RF_PEAK} = 100\text{ mV}_P$ (-20 dB_P), $f = 900\text{ MHz}$		90		
			$V_{RF_PEAK} = 100\text{ mV}_P$ (-20 dB_P), $f = 1800\text{ MHz}$		110		
			$V_{RF_PEAK} = 100\text{ mV}_P$ (-20 dB_P), $f = 2400\text{ MHz}$		120		
CMVR	Input common-mode voltage range	CMRR $\geq 65\text{ dB}$		-0.1	3.8	V	

- (1) Electrical Table values apply only for factory testing conditions at the temperature indicated. Factory testing conditions result in very limited self-heating of the device such that $T_J = T_A$. No specification of parametric performance is indicated in the electrical tables under conditions of internal self-heating where $T_J > T_A$.
- (2) Limits are 100% production tested at 25°C . Limits over the operating temperature range are specified through correlations using statistical quality control (SQC) method.
- (3) Typical values represent the most likely parametric norm as determined at the time of characterization. Actual typical values may vary over time and will also depend on the application and configuration. The typical values are not tested and are not ensured on shipped production material.
- (4) The typical value is calculated by applying absolute value transform to the distribution, then taking the statistical average of the resulting distribution.
- (5) This parameter is specified by design and/or characterization and is not tested in production.
- (6) The EMI Rejection Ratio is defined as $EMIRR = 20\log(V_{RF_PEAK}/\Delta V_{OS})$.

Electrical Characteristics, 5 V (continued)

 Unless otherwise specified, all limits are specified for at $T_A = 25^\circ\text{C}$, $V^+ = 5\text{ V}$, $V^- = 0\text{ V}$, $V_{\text{CM}} = V^+/2$, and $R_L = 10\text{ k}\Omega$ to $V^+/2$. ⁽¹⁾

PARAMETER		TEST CONDITIONS		MIN ⁽²⁾	TYP ⁽³⁾	MAX ⁽²⁾	UNIT
A _{VOL}	Large signal voltage gain ⁽⁷⁾	$R_L = 2\text{ k}\Omega$, $V_{\text{OUT}} = 0.15\text{ V to }2.5\text{ V}$, $V_{\text{OUT}} = 4.85\text{ V to }2.5\text{ V}$	LMV831, LMV832	107	127		dB
			LMV831, LMV832, $-40^\circ\text{C} \leq T_A \leq +125^\circ\text{C}$	106			
			LMV834	104	127		
			LMV834, $-40^\circ\text{C} \leq T_A \leq +125^\circ\text{C}$	104			
		$R_L = 10\text{ k}\Omega$, $V_{\text{OUT}} = 0.1\text{ V to }2.5\text{ V}$, $V_{\text{OUT}} = 4.9\text{ V to }2.5\text{ V}$	LMV831, LMV832	107	130		
			LMV831, LMV832, $-40^\circ\text{C} \leq T_A \leq +125^\circ\text{C}$	107			
			LMV834	105	127		
			LMV834, $-40^\circ\text{C} \leq T_A \leq +125^\circ\text{C}$	104			
V _{OUT}	Output voltage swing high	$R_L = 2\text{ k}\Omega$ to $V^+/2$	LMV831, LMV832		32	42	mV from either rail
			LMV831, LMV832, $-40^\circ\text{C} \leq T_A \leq +125^\circ\text{C}$			49	
			LMV834		35	45	
			LMV834, $-40^\circ\text{C} \leq T_A \leq +125^\circ\text{C}$			52	
		$R_L = 10\text{ k}\Omega$ to $V^+/2$	LMV831, LMV832		6	9	
			LMV831, LMV832, $-40^\circ\text{C} \leq T_A \leq +125^\circ\text{C}$			10	
			LMV834		7	10	
			LMV834, $-40^\circ\text{C} \leq T_A \leq +125^\circ\text{C}$			11	
	Output voltage swing low	$R_L = 2\text{ k}\Omega$ to $V^+/2$	$T_A = 25^\circ\text{C}$		27	43	
			$-40^\circ\text{C} \leq T_A \leq +125^\circ\text{C}$			52	
		$R_L = 10\text{ k}\Omega$ to $V^+/2$	$T_A = 25^\circ\text{C}$		6	10	
			$-40^\circ\text{C} \leq T_A \leq +125^\circ\text{C}$			12	
I _{OUT}	Output short circuit current	Sourcing $V_{\text{OUT}} = V_{\text{CM}}$ $V_{\text{IN}} = 100\text{ mV}$	LMV831, LMV832	59	66	mA	
			LMV831, LMV832, $-40^\circ\text{C} \leq T_A \leq +125^\circ\text{C}$	49			
			LMV834	57	63		
			LMV834, $-40^\circ\text{C} \leq T_A \leq +125^\circ\text{C}$	45			
		Sinking $V_{\text{OUT}} = V_{\text{CM}}$ $V_{\text{IN}} = -100\text{ mV}$	LMV831, LMV832	50	64		
			LMV831, LMV832, $-40^\circ\text{C} \leq T_A \leq +125^\circ\text{C}$	41			
			LMV834	53	63		
			LMV834, $-40^\circ\text{C} \leq T_A \leq +125^\circ\text{C}$	41			

(7) The specified limits represent the lower of the measured values for each output range condition.

Electrical Characteristics, 5 V (continued)

 Unless otherwise specified, all limits are specified for at $T_A = 25^\circ\text{C}$, $V^+ = 5\text{ V}$, $V^- = 0\text{ V}$, $V_{\text{CM}} = V^+/2$, and $R_L = 10\text{ k}\Omega$ to $V^+/2$. ⁽¹⁾

PARAMETER		TEST CONDITIONS	MIN ⁽²⁾	TYP ⁽³⁾	MAX ⁽²⁾	UNIT
I_S	Supply current	LMV831		0.25	0.27	mA
		LMV831, $-40^\circ\text{C} \leq T_A \leq +125^\circ\text{C}$			0.31	
		LMV832		0.47	0.52	
		LMV832, $-40^\circ\text{C} \leq T_A \leq +125^\circ\text{C}$			0.6	
		LMV834		0.92	1.02	
		LMV834, $-40^\circ\text{C} \leq T_A \leq +125^\circ\text{C}$			1.18	
SR	Slew rate ⁽⁸⁾	$A_V = +1$, $V_{\text{OUT}} = 2 V_{\text{PP}}$, 10% to 90%		2		V/ μs
GBW	Gain bandwidth product			3.3		MHz
Φ_m	Phase margin			65		deg
e_n	Input referred voltage noise	$f = 1\text{ kHz}$		12		nV/ $\sqrt{\text{Hz}}$
		$f = 10\text{ kHz}$		10		
i_n	Input referred current noise	$f = 1\text{ kHz}$		0.005		pA/ $\sqrt{\text{Hz}}$
R_{OUT}	Closed-loop output impedance	$f = 2\text{ MHz}$		500		Ω
C_{IN}	Common-mode input capacitance			14		pF
	Differential-mode input capacitance			20		
THD+N	Total harmonic distortion + noise	$f = 1\text{ kHz}$, $A_V = 1$, $\text{BW} \geq 500\text{ kHz}$		0.02%		

(8) Number specified is the slower of positive and negative slew rates.

6.7 Typical Characteristics

At $T_A = 25^\circ\text{C}$, $R_L = 10\text{ k}\Omega$, $V^+ = 3.3\text{ V}$, $V^- = 0\text{ V}$, Unless otherwise specified.

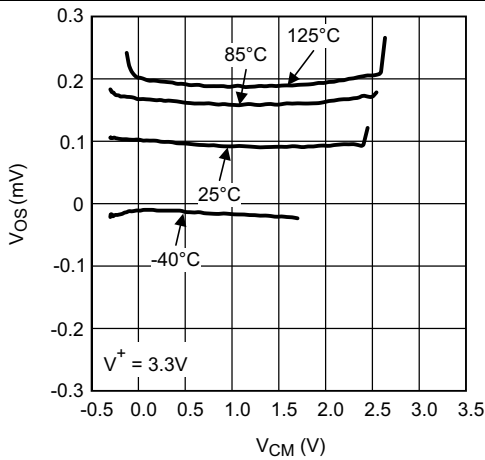

Figure 1. V_{OS} vs V_{CM} at $V^+ = 3.3\text{ V}$

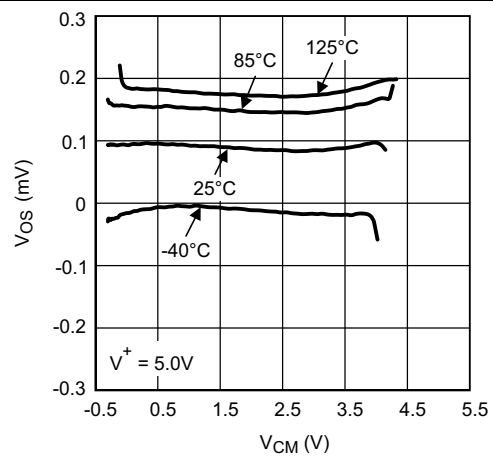

Figure 2. V_{OS} vs V_{CM} at $V^+ = 5\text{ V}$

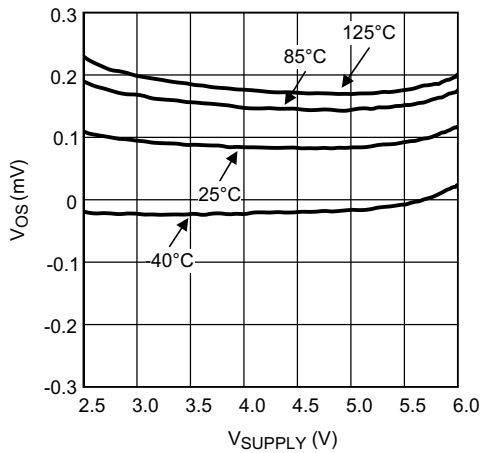

Figure 3. V_{OS} vs Supply Voltage

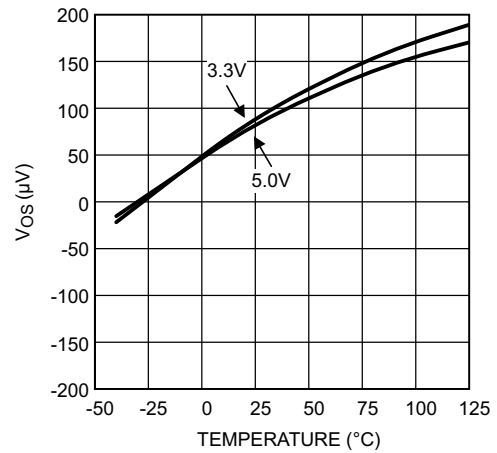

Figure 4. V_{OS} vs Temperature

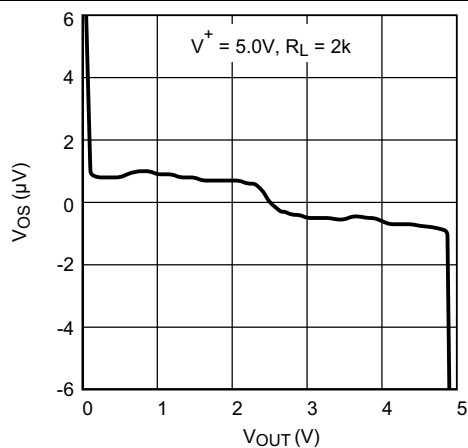

Figure 5. V_{OS} vs V_{OUT}

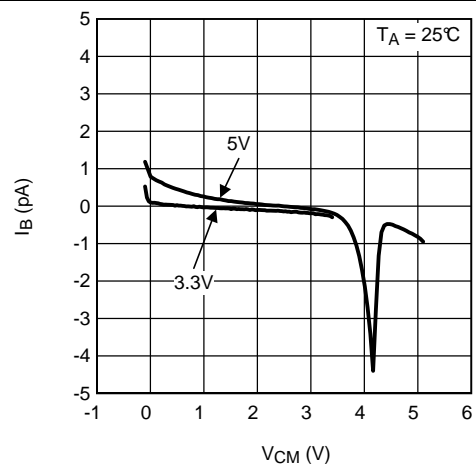

Figure 6. Input Bias Current vs V_{CM} at 25°C

Typical Characteristics (continued)

At $T_A = 25^\circ\text{C}$, $R_L = 10\text{ k}\Omega$, $V^+ = 3.3\text{ V}$, $V^- = 0\text{ V}$, Unless otherwise specified.

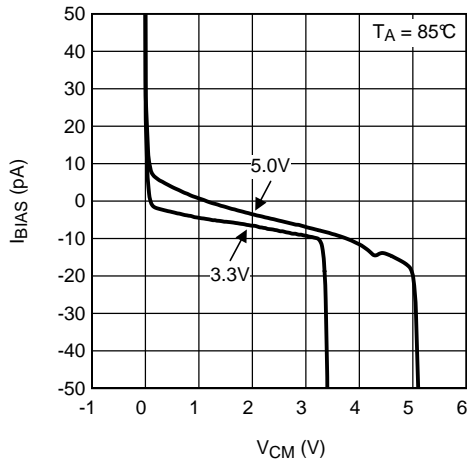

Figure 7. Input Bias Current vs V_{CM} at 85°C

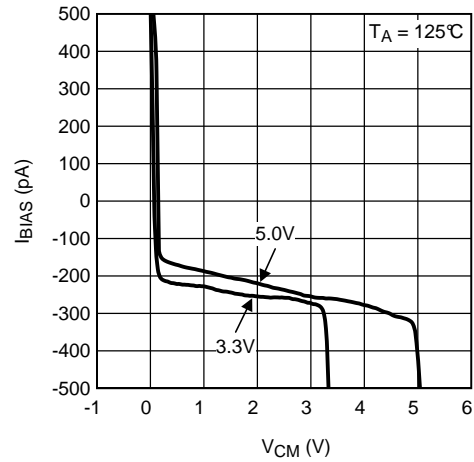

Figure 8. Input Bias Current vs V_{CM} at 125°C

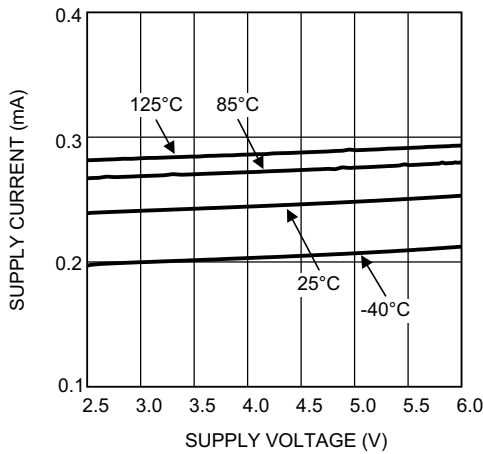

Figure 9. Supply Current vs Supply Voltage Single LMV831

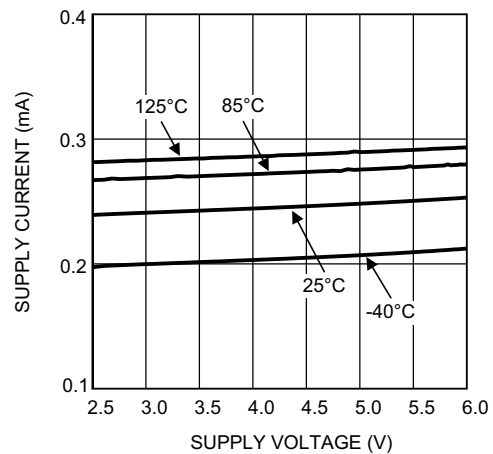

Figure 10. Supply Current vs Supply Voltage Dual LMV832

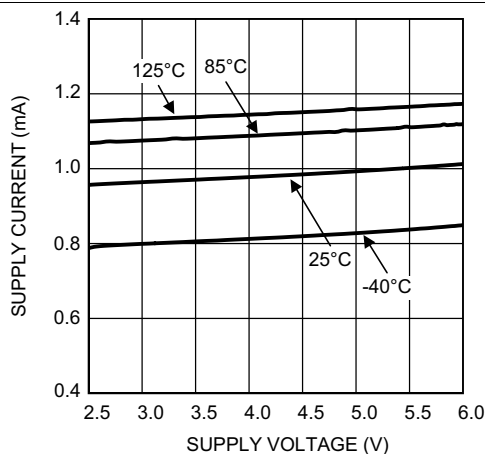

Figure 11. Supply Current vs Supply Voltage Quad LMV834

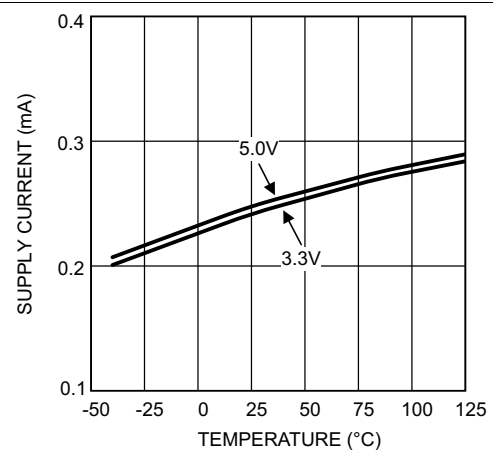
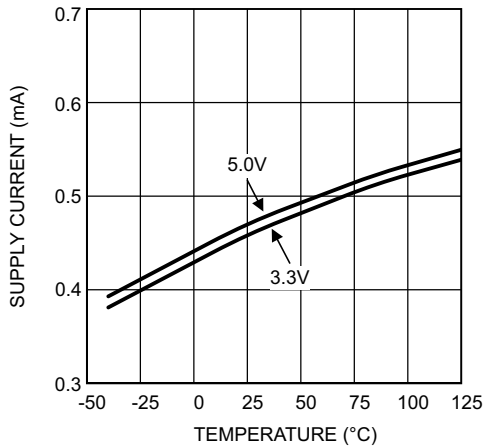
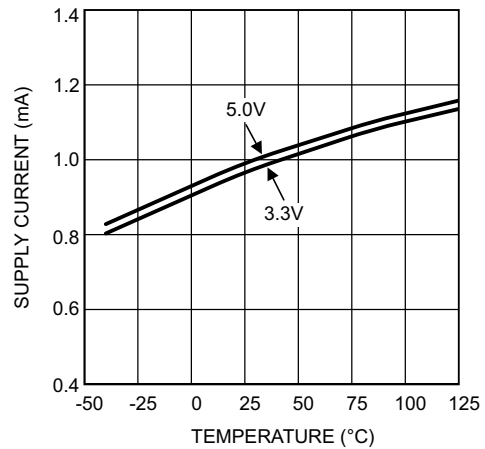
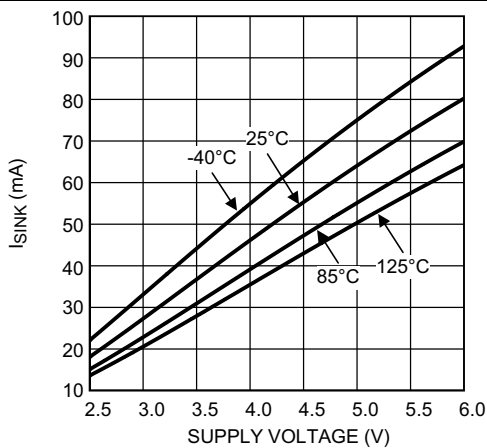
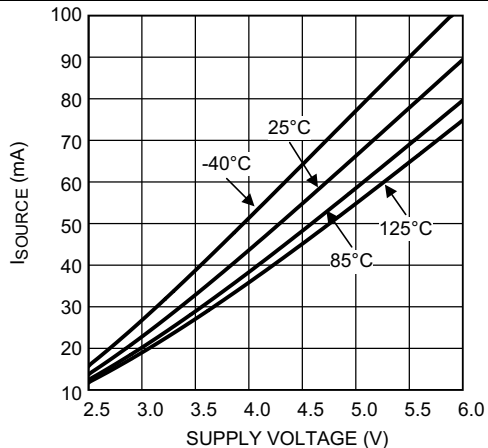
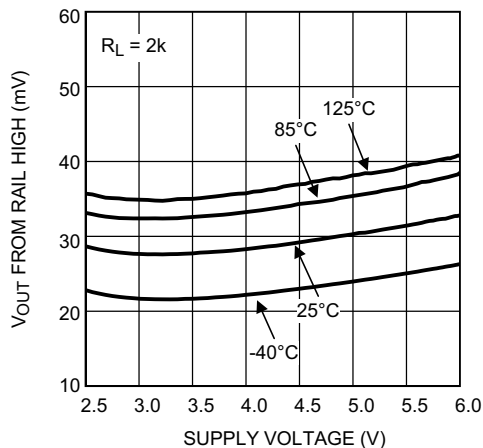
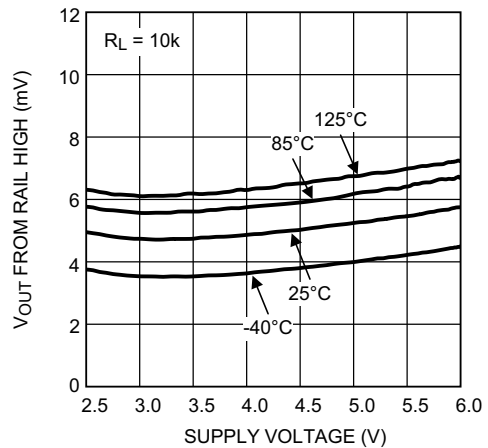

Figure 12. Supply Current vs Temperature Single LMV831

Typical Characteristics (continued)

 At $T_A = 25^\circ\text{C}$, $R_L = 10\text{ k}\Omega$, $V^+ = 3.3\text{ V}$, $V^- = 0\text{ V}$, Unless otherwise specified.

Figure 13. Supply Current vs Temperature Dual LMV832

Figure 14. Supply Current vs Temperature Quad LMV834

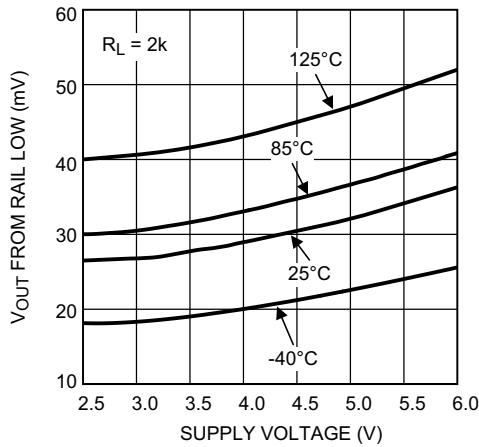
Figure 15. Sinking Current vs Supply Voltage

Figure 16. Sourcing Current vs Supply Voltage

 $R_L = 2\text{ k}\Omega$
Figure 17. Output Swing High vs Supply Voltage

 $R_L = 10\text{ k}\Omega$
Figure 18. Output Swing High vs Supply Voltage

Typical Characteristics (continued)

At $T_A = 25^\circ\text{C}$, $R_L = 10\text{ k}\Omega$, $V^+ = 3.3\text{ V}$, $V^- = 0\text{ V}$, Unless otherwise specified.



$R_L = 2\text{ k}\Omega$

Figure 19. Output Swing Low vs Supply Voltage

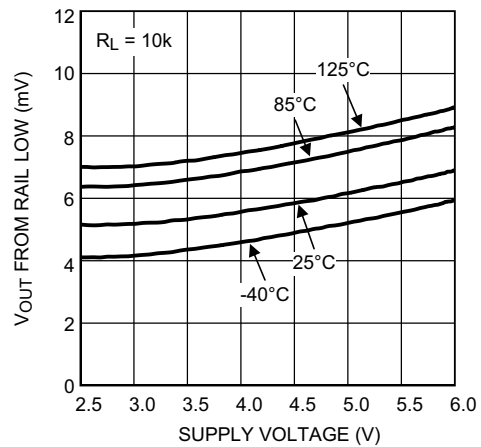

$R_L = 10\text{ k}\Omega$

Figure 20. Output Swing Low vs Supply Voltage

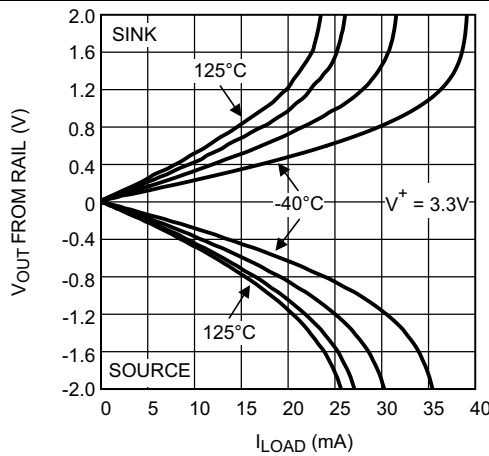

Figure 21. Output Voltage Swing vs Load Current at $V^+ = 3.3\text{ V}$

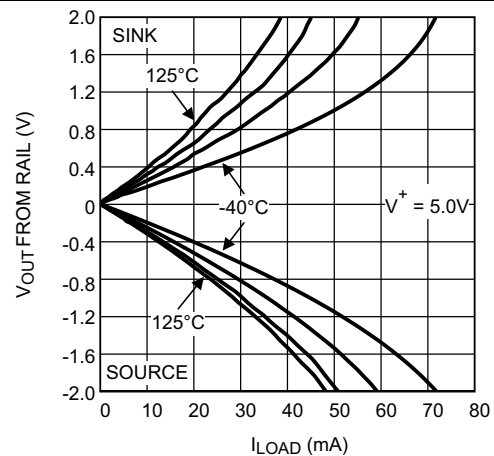

Figure 22. Output Voltage Swing vs Load Current at $V^+ = 5\text{ V}$

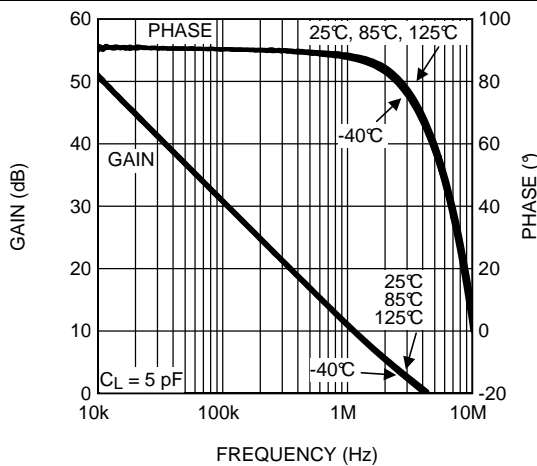

Figure 23. Open-Loop Frequency Response vs Temperature

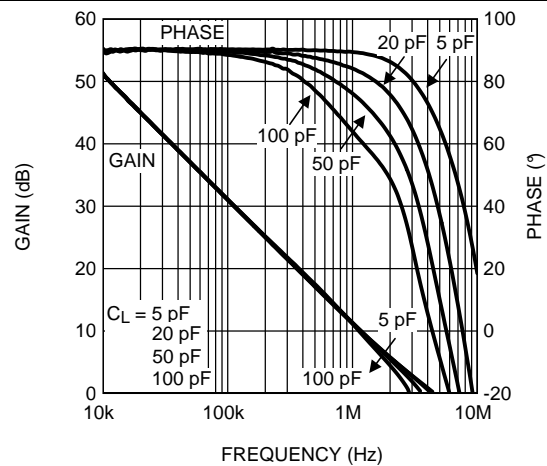

Figure 24. Open-Loop Frequency Response vs Load Conditions

Typical Characteristics (continued)

At $T_A = 25^\circ\text{C}$, $R_L = 10\text{ k}\Omega$, $V^+ = 3.3\text{ V}$, $V^- = 0\text{ V}$, Unless otherwise specified.

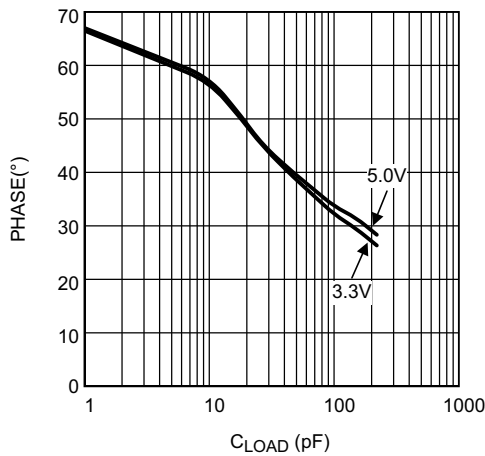

Figure 25. Phase Margin vs Capacitive Load

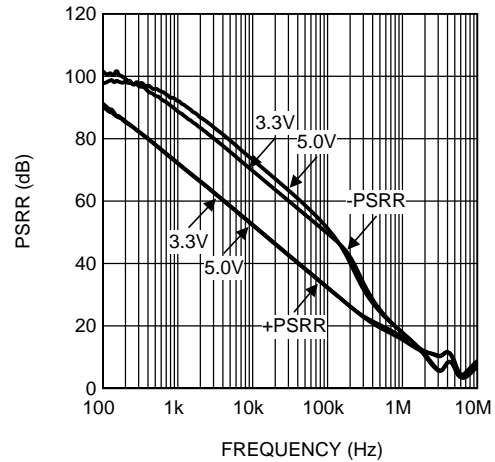

Figure 26. PSRR vs Frequency

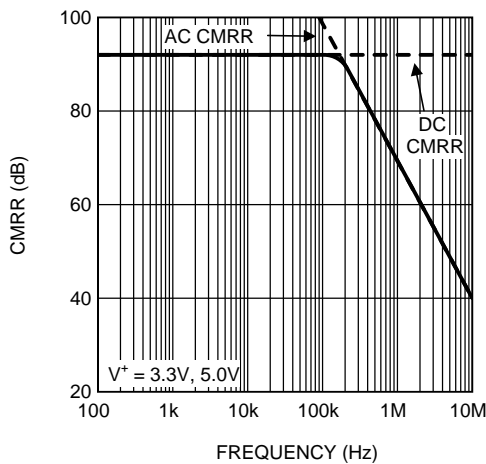

Figure 27. CMRR vs Frequency

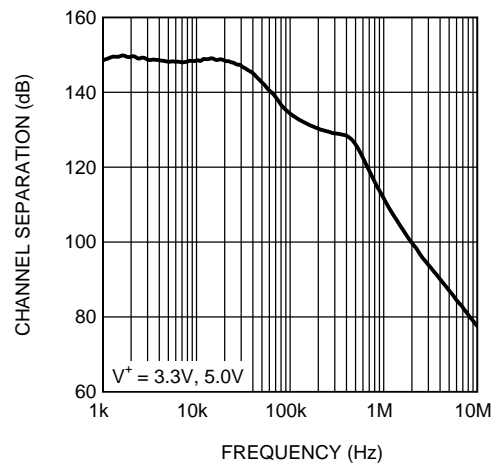

Figure 28. Channel Separation vs Frequency

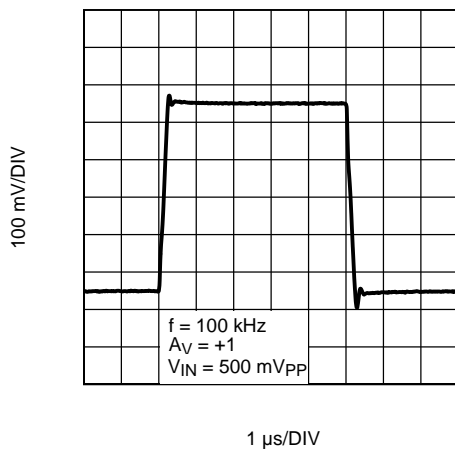

Figure 29. Large Signal Step Response With Gain = 1

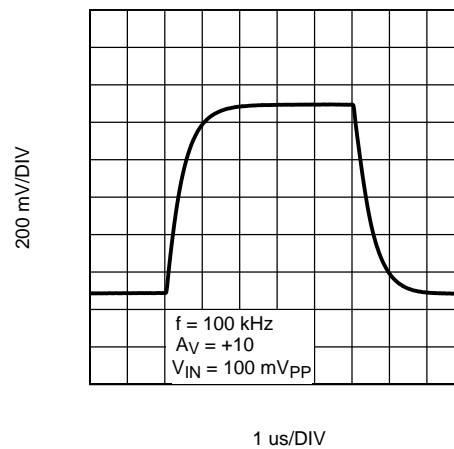

Figure 30. Large Signal Step Response With Gain = 10

Typical Characteristics (continued)

At $T_A = 25^\circ\text{C}$, $R_L = 10\text{ k}\Omega$, $V^+ = 3.3\text{ V}$, $V^- = 0\text{ V}$, Unless otherwise specified.

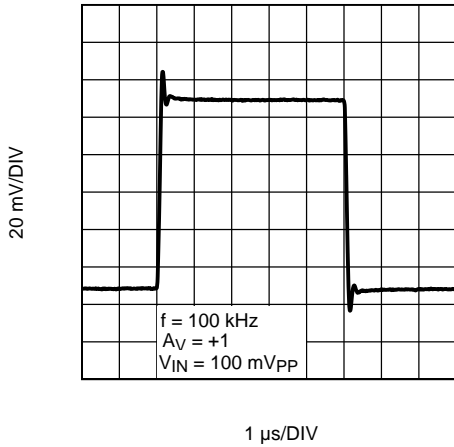

Figure 31. Small Signal Step Response With Gain = 1

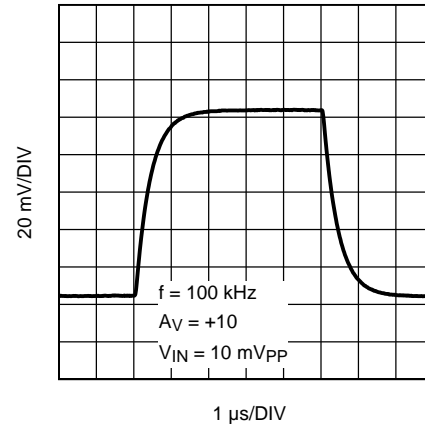

Figure 32. Small Signal Step Response With Gain = 10

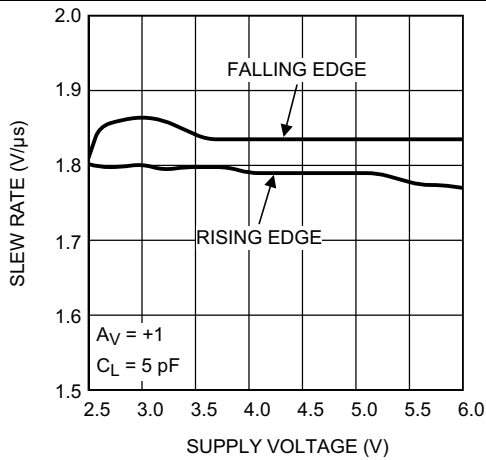

Figure 33. Slew Rate vs Supply Voltage

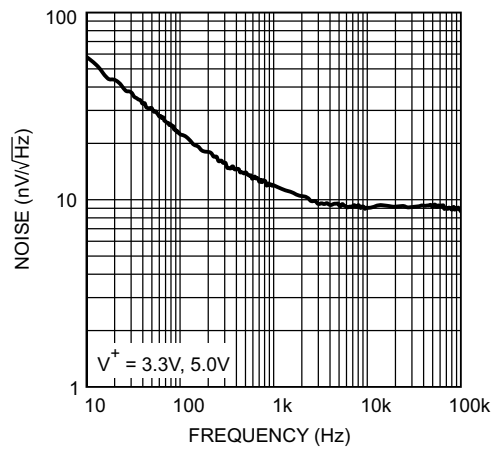

Figure 34. Input Voltage Noise vs Frequency

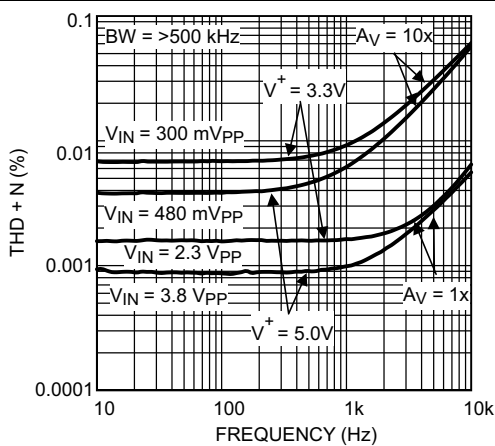

Figure 35. THD+N vs Frequency

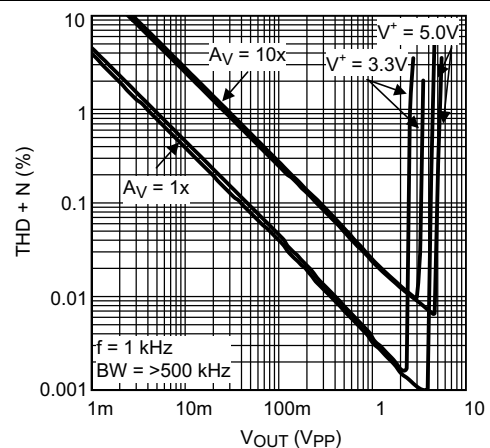

Figure 36. THD+N vs Amplitude

Typical Characteristics (continued)

At $T_A = 25^\circ\text{C}$, $R_L = 10\text{ k}\Omega$, $V^+ = 3.3\text{ V}$, $V^- = 0\text{ V}$, Unless otherwise specified.

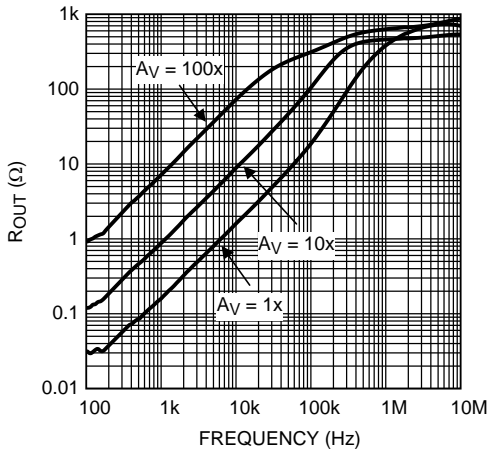

Figure 37. R_{OUT} vs Frequency

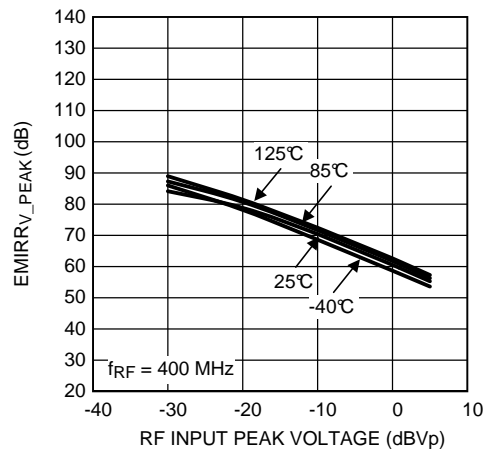

Figure 38. EMIRR IN+ vs Power at 400 MHz

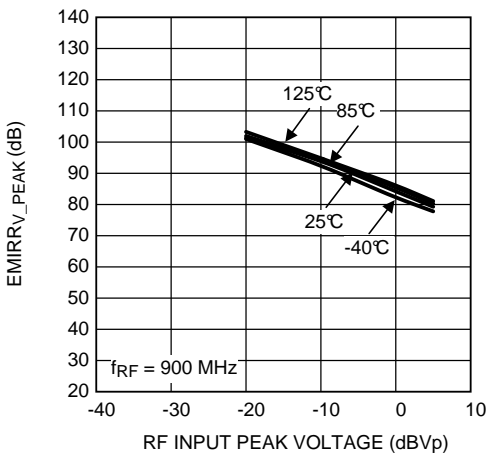

Figure 39. EMIRR IN+ vs Power at 900 MHz

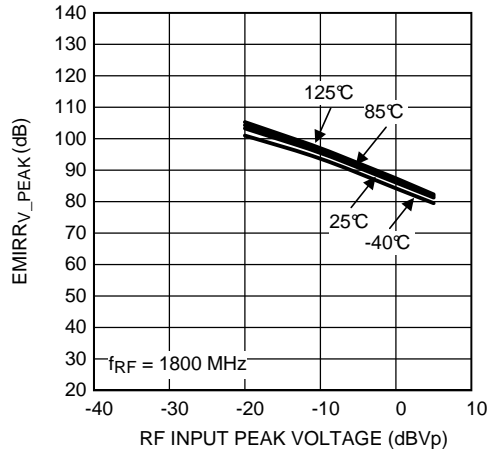

Figure 40. EMIRR IN+ vs Power at 1800 MHz

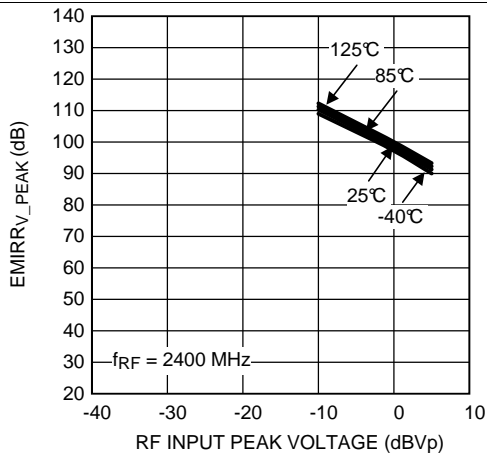

Figure 41. EMIRR IN+ vs Power at 2400 MHz

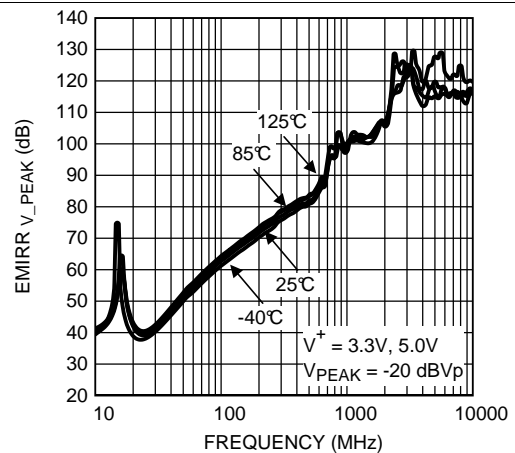

Figure 42. EMIRR IN+ vs Frequency

7 Detailed Description

7.1 Overview

The LMV831, LMV832, and LMV834 are operational amplifiers with excellent specifications, such as low offset, low noise and a rail-to-rail output. The EMI hardening makes the LMV831, LMV832 or LMV834 a must for almost all operational amplifier applications that are exposed to Radio Frequency (RF) signals such as the signals transmitted by mobile phones or wireless computer peripherals. The LMV831, LMV832, and LMV834 will effectively reduce disturbances caused by RF signals to a level that will be hardly noticeable. This again reduces the need for additional filtering and shielding. Using this EMI resistant series of operational amplifiers will thus reduce the number of components and space needed for applications that are affected by EMI, and will help applications, not yet identified as possible EMI sensitive, to be more robust for EMI.

7.2 Functional Block Diagram

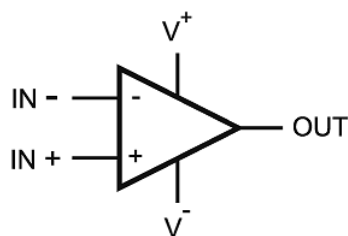

7.3 Feature Description

7.3.1 Input Characteristics

The input common-mode voltage range of the LMV831, LMV832, and LMV834 includes ground, and can even sense well below ground. The CMRR level does not degrade for input levels up to 1.2 V below the supply voltage. For a supply voltage of 5 V, the maximum voltage that should be applied to the input for best CMRR performance is thus 3.8 V.

When not configured as unity gain, this input limitation will usually not degrade the effective signal range. The output is rail-to-rail and therefore will introduce no limitations to the signal range.

The typical offset is only 0.25 mV, and the TCV_{OS} is 0.5 $\mu\text{V}/^\circ\text{C}$, specifications close to precision operational amplifiers.

7.3.2 EMIRR

With the increase of RF transmitting devices in the world, the electromagnetic interference (EMI) between those devices and other equipment becomes a bigger challenge. The LMV831, LMV832, and LMV834 are EMI-hardened operational amplifiers which are specifically designed to overcome electromagnetic interference. Along with EMI-hardened operational amplifiers, the EMIRR parameter is introduced to unambiguously specify the EMI performance of an operational amplifier. This section presents an overview of EMIRR. A detailed description on this specification for EMI-hardened operational amplifiers can be found in AN-1698 ([SNOA497](#)).

The dimensions of an operational amplifier IC are relatively small compared to the wavelength of the disturbing RF signals. As a result the operational amplifier itself will hardly receive any disturbances. The RF signals interfering with the operational amplifier are dominantly received by the PCB and wiring connected to the operational amplifier. As a result the RF signals on the pins of the operational amplifier can be represented by voltages and currents. This representation significantly simplifies the unambiguous measurement and specification of the EMI performance of an operational amplifier.

RF signals interfere with operational amplifiers through the non-linearity of the operational amplifier circuitry. This non-linearity results in the detection of the so called out-of-band signals. The obtained effect is that the amplitude modulation of the out-of-band signal is downconverted into the base band. This base band can easily overlap with the band of the operational amplifier circuit. As an example [Figure 43](#) depicts a typical output signal of a unity-gain connected operational amplifier in the presence of an interfering RF signal. Clearly the output voltage varies in the rhythm of the on-off keying of the RF carrier.

Feature Description (continued)

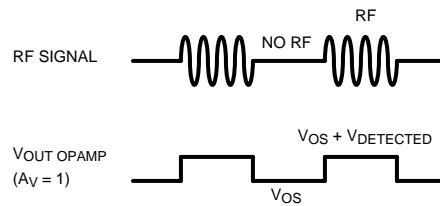

Figure 43. Offset Voltage Variation Due to an Interfering RF Signal

7.3.3 EMIRR Definition

To identify EMI-hardened operational amplifiers, a parameter is needed that quantitatively describes the EMI performance of operational amplifiers. A quantitative measure enables the comparison and the ranking of operational amplifiers on their EMI robustness. Therefore the EMI Rejection Ratio (EMIRR) is introduced. This parameter describes the resulting input-referred offset voltage shift of an operational amplifier as a result of an applied RF carrier (interference) with a certain frequency and level. The definition of EMIRR is given by [Equation 1](#):

$$\text{EMIRR}_{V_{\text{RF_PEAK}}} = 20 \log \left(\frac{V_{\text{RF_PEAK}}}{\Delta V_{\text{OS}}} \right)$$

In which

- $V_{\text{RF_PEAK}}$ is the amplitude of the applied un-modulated RF signal (V)
- ΔV_{OS} is the resulting input-referred offset voltage shift (V) (1)

The offset voltage depends quadratically on the applied RF level, and therefore, the RF level at which the EMIRR is determined should be specified. The standard level for the RF signal is 100 mV_p. AN-1698 ([SNOA497](#)) addresses the conversion of an EMIRR measured for an other signal level than 100 mV_p. The interpretation of the EMIRR parameter is straightforward. When two operational amplifiers have an EMIRR which differ by 20 dB, the resulting error signals when used in identical configurations, differ by 20 dB as well. So, the higher the EMIRR, the more robust the operational amplifier.

7.3.3.1 Coupling an RF Signal to the IN+ Pin

Each of the operational amplifier pins can be tested separately on EMIRR. In this section, the measurements on the IN+ pin (which, based on symmetry considerations, also apply to the IN– pin) are discussed. In AN-1698 ([SNOA497](#)) the other pins of the operational amplifier are treated as well. For testing the IN+ pin the operational amplifier is connected in the unity gain configuration. Applying the RF signal is straightforward as it can be connected directly to the IN+ pin. As a result the RF signal path has a minimum of components that might affect the RF signal level at the pin. The circuit diagram is shown in [Figure 44](#). The PCB trace from RF_{IN} to the IN+ pin should be a 50-Ω stripline in order to match the RF impedance of the cabling and the RF generator. On the PCB a 50-Ω termination is used. This 50-Ω resistor is also used to set the bias level of the IN+ pin to ground level. For determining the EMIRR, two measurements are needed: one is measuring the DC output level when the RF signal is off; and the other is measuring the DC output level when the RF signal is switched on. The difference of the two DC levels is the output voltage shift as a result of the RF signal. As the operational amplifier is in the unity-gain configuration, the input referred offset voltage shift corresponds one-to-one to the measured output voltage shift.

Feature Description (continued)

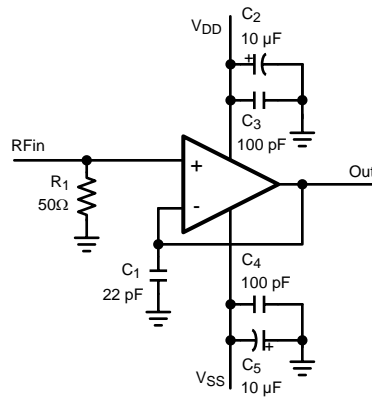

Figure 44. Circuit for Coupling the RF Signal to IN+

7.3.3.2 Cell Phone Call

The effect of electromagnetic interference is demonstrated in a set-up where a cell phone interferes with a pressure sensor application. The application is shown in [Figure 49](#).

This application needs two operational amplifiers and therefore a dual operational amplifier is used. The operational amplifier configured as a buffer and connected at the negative output of the pressure sensor prevents the loading of the bridge by resistor R2. The buffer also prevents the resistors of the sensor from affecting the gain of the following gain stage. The operational amplifiers are placed in a single-supply configuration.

The experiment is performed on two different dual operational amplifiers: a typical standard operational amplifier and the LMV832, EMI-hardened dual operational amplifier. A cell phone is placed on a fixed position a couple of centimeters from the operational amplifiers in the sensor circuit.

When the cell phone is called, the PCB and wiring connected to the operational amplifiers receive the RF signal. Subsequently, the operational amplifiers detect the RF voltages and currents that end up at their pins. The resulting effect on the output of the second operational amplifier is shown in [Figure 45](#).

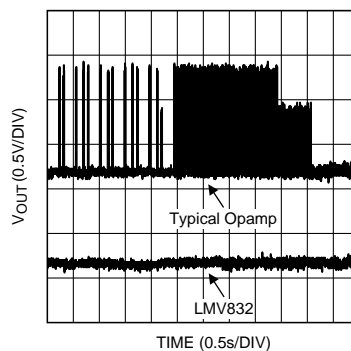

Figure 45. Comparing EMI Robustness

The difference between the two types of dual operational amplifiers is clearly visible. The typical standard dual operational amplifier has an output shift (disturbed signal) larger than 1 V as a result of the RF signal transmitted by the cell phone. The LMV832, EMI-hardened operational amplifier does not show any significant disturbances. This means that the RF signal will not disturb the signal entering the ADC when using the LMV832.

7.4 Device Functional Modes

7.4.1 Output Characteristics

As already mentioned the output is rail-to-rail. When loading the output with a 10-kΩ resistor the maximum swing of the output is typically 6 mV from the positive and negative rail.

The output of the LMV83x can drive currents up to 30 mA at 3.3 V and even up to 65 mA at 5 V.

The LMV83x can be connected as noninverting unity-gain amplifiers. This configuration is the most sensitive to capacitive loading. The combination of a capacitive load placed at the output of an amplifier along with the output impedance of the amplifier creates a phase lag, which reduces the phase margin of the amplifier. If the phase margin is significantly reduced, the response will be under damped which causes peaking in the transfer and, when there is too much peaking, the operational amplifier might start oscillating. The LMV83x can directly drive capacitive loads up to 200 pF without any stability issues. In order to drive heavier capacitive loads, an isolation resistor, R_{ISO} , should be used, as shown in Figure 46. By using this isolation resistor, the capacitive load is isolated from the output of the amplifier, and hence, the pole caused by C_L is no longer in the feedback loop. The larger the value of R_{ISO} , the more stable the amplifier will be. If the value of R_{ISO} is sufficiently large, the feedback loop will be stable, independent of the value of C_L . However, larger values of R_{ISO} result in reduced output swing and reduced output current drive.

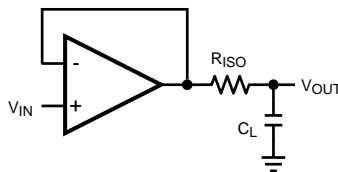

Figure 46. Isolating Capacitive Load

A resistor value of around 150 Ω would be sufficient. As an example some values are given in Table 1, for 5 V.

Table 1. Resistor Values

C_{LOAD}	R_{ISO}
300 pF	165 Ω
400 pF	175 Ω
500 pF	185 Ω

7.4.2 CMRR Measurement

The CMRR measurement results may need some clarification. This is because different set-ups are used to measure the AC CMRR and the DC CMRR.

The DC CMRR is derived from ΔV_{OS} versus ΔV_{CM} . This value is stated in the tables, and is tested during production testing. The AC CMRR is measured with the test circuit shown in Figure 47.

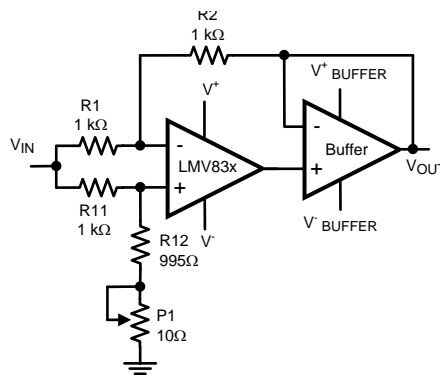

Figure 47. AC CMRR Measurement Set-Up

The configuration is largely the usually applied balanced configuration. With potentiometer P1, the balance can be tuned to compensate for the DC offset in the DUT. The main difference is the addition of the buffer. This buffer prevents the open-loop output impedance of the DUT from affecting the balance of the feedback network. Now the closed-loop output impedance of the buffer is a part of the balance. As the closed-loop output impedance is much lower, and by careful selection of the buffer also has a larger bandwidth, the total effect is that the CMRR of the DUT can be measured much more accurately. The differences are apparent in the larger measured bandwidth of the AC CMRR.

One artifact from this test circuit is that the low frequency CMRR results appear higher than expected. This is because in the AC CMRR test circuit the potentiometer is used to compensate for the DC mismatches. So, mainly AC mismatch is all that remains. Therefore, the obtained DC CMRR from this AC CMRR test circuit tends to be higher than the actual DC CMRR based on DC measurements.

The CMRR curve in [Figure 48](#) shows a combination of the AC CMRR and the DC CMRR.

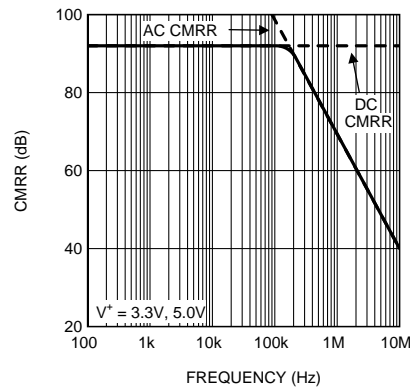

Figure 48. CMRR Curve

8 Application and Implementation

NOTE

Information in the following applications sections is not part of the TI component specification, and TI does not warrant its accuracy or completeness. TI's customers are responsible for determining suitability of components for their purposes. Customers should validate and test their design implementation to confirm system functionality.

8.1 Application Information

The LMV83x family of amplifiers is specified for operation from 2.7 V to 5.5 V (± 1.35 V to ± 2.25 V). Parameters that can exhibit significant variance with regard to operating voltage or temperature are presented in the [Typical Characteristics](#).

8.2 Typical Application

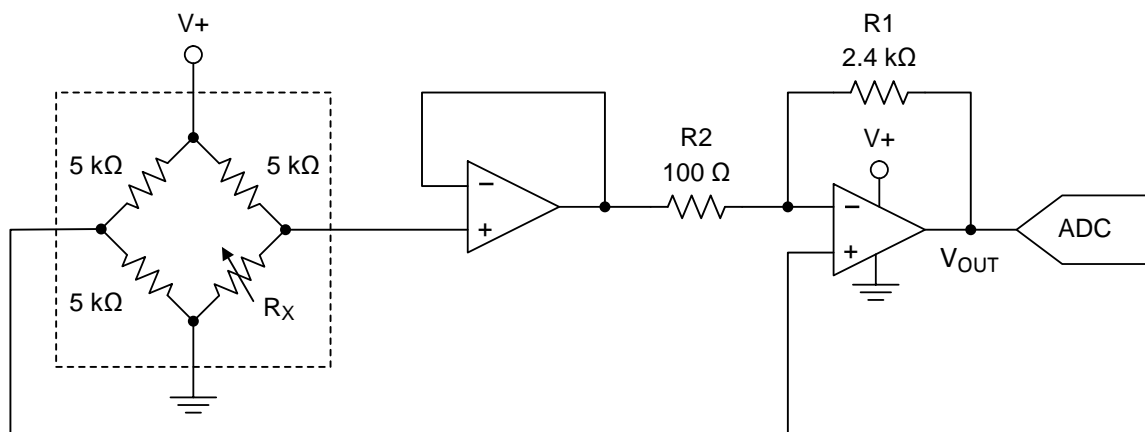

Figure 49. Pressure Sensor Application

8.2.1 Design Requirements

The LMV83x can be used for pressure sensor applications. Because of their low power the LMV83x are ideal for portable applications, such as blood pressure measurement devices, or portable barometers. This example describes a universal pressure sensor that can be used as a starting point for different types of sensors and applications.

The pressure sensor used in this example functions as a Wheatstone bridge. The value of the resistors in the bridge change when pressure is applied to the sensor. This change of the resistor values will result in a differential output voltage, depending on the sensitivity of the sensor and the applied pressure.

8.2.2 Detailed Design Procedure

The difference between the output at full-scale pressure and the output at zero pressure is defined as the span of the pressure sensor. A typical value for the span is 100 mV. A typical value for the resistors in the bridge is 5 kΩ. Loading of the resistor bridge could result in incorrect output voltages of the sensor. Therefore the selection of the circuit configuration, which connects to the sensor, should take into account a minimum loading of the sensor.

The configuration shown in [Figure 49](#) is simple, and is very useful for the read out of pressure sensors. With two operational amplifiers in this application, the dual LMV832 fits very well. The operational amplifier configured as a buffer and connected at the negative output of the pressure sensor prevents the loading of the bridge by resistor R2. The buffer also prevents the resistors of the sensor from affecting the gain of the following gain stage. Given the differential output voltage V_S of the pressure sensor, the output signal of this operational amplifier configuration, V_{OUT} , equals [Equation 2](#):

Typical Application (continued)

$$V_{OUT} = \frac{V_{DD}}{2} - \frac{V_S}{2} \left(1 + 2 \times \frac{R1}{R2} \right) \tag{2}$$

To align the pressure range with the full range of an ADC, the power supply voltage and the span of the pressure sensor are needed. For this example a power supply of 5 V is used and the span of the sensor is 100 mV. When a 100-Ω resistor is used for R2, and a 2.4-kΩ resistor is used for R1, the maximum voltage at the output is 4.95 V and the minimum voltage is 0.05 V. This signal is covering almost the full input range of the ADC. Further processing can take place in the microprocessor following the ADC.

8.2.3 Application Curve

Figure 50 shows the resulting output voltage as R_x is varied between 4.5 kΩ and 5.5 kΩ.

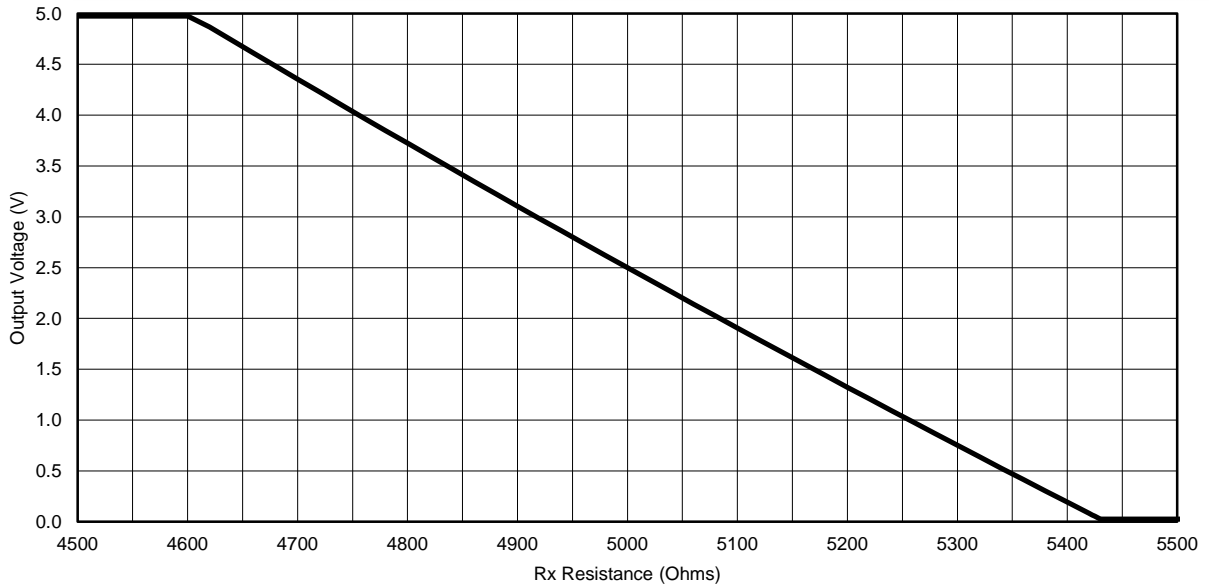

Figure 50. Output Voltage vs R_x

9 Power Supply Recommendations

For proper operation, the power supplies must be properly decoupled. For decoupling the supply lines, TI recommends that 10-nF capacitors be placed as close as possible to the operational amplifier power supply pins. For single-supply, place a capacitor between V+ and V– supply leads. For dual supplies, place one capacitor between V+ and ground, and one capacitor between V– and ground.

CAUTION

Supply voltages larger than 6 V can permanently damage the device.

The internal RFI filters shunt the received EMI energy to the supply pins. To maximize the effectiveness of the built-in EMI filters, the power supply pin bypassing should have a low impedance, low inductance path to RF ground.

The normally suggested 0.1- μ F and larger capacitors tend to be inductive over the effective frequency range of the EMI filters and are not effective at filtering high frequencies (> 50 MHz). Capacitors with high self-resonance frequencies near the GHz range should be placed at the supply pins. This can be accomplished with small (0805 or less) 10 pF to 100 pF SMT ceramic capacitors placed directly at the supply pins to a solid RF ground. These capacitors will provide a direct AC path for the high-frequency EMI to ground. These capacitors are in addition to, and not a replacement for, the recommended low-frequency supply bypassing capacitors.

10 Layout

10.1 Layout Guidelines

- Connect low-ESR, 0.1- μ F ceramic bypass capacitors between each supply pin and ground, placed as close to the device as possible. A single bypass capacitor from V^+ to ground is applicable for single-supply applications.
- For single-supply, place a capacitor between V^+ and V^- .
- For dual supplies, place one capacitor between V^+ and the board ground, and a second capacitor between ground and V^- .
- Noise can propagate into analog circuitry through the power pins of the circuit as a whole and operational amplifier itself. Bypass capacitors are used to reduce the coupled noise by providing low-impedance power sources local to the analog circuitry.
- Separate grounding for analog and digital portions of circuitry is one of the simplest and most-effective methods of noise suppression. One or more layers on multilayer PCBs are usually devoted to ground planes. A ground plane helps distribute heat and reduces EMI noise pick-up. Make sure to physically separate digital and analog grounds paying attention to the flow of the ground current. For more detailed information refer to *Circuit Board Layout Techniques*, [SLOA089](#).
- In order to reduce parasitic coupling, run the input traces as far away from the supply or output traces as possible. If it is not possible to keep them separate, it is much better to cross the sensitive trace perpendicular as opposed to in parallel with the noisy trace.
- Place the external components as close to the device as possible, keeping R_F and R_G close to the inverting input minimizes parasitic capacitance.
- Keep the length of input traces as short as possible. Always remember that the input traces are the most sensitive part of the circuit.

Even with the LMV83x inherent hardening against EMI, TI still recommends to keep the input traces short and as far as possible from RF sources. Then the RF signals entering the chip are as low as possible, and the remaining EMI can be, almost, completely eliminated in the chip by the EMI reducing features of the LMV83x.

10.2 Layout Example

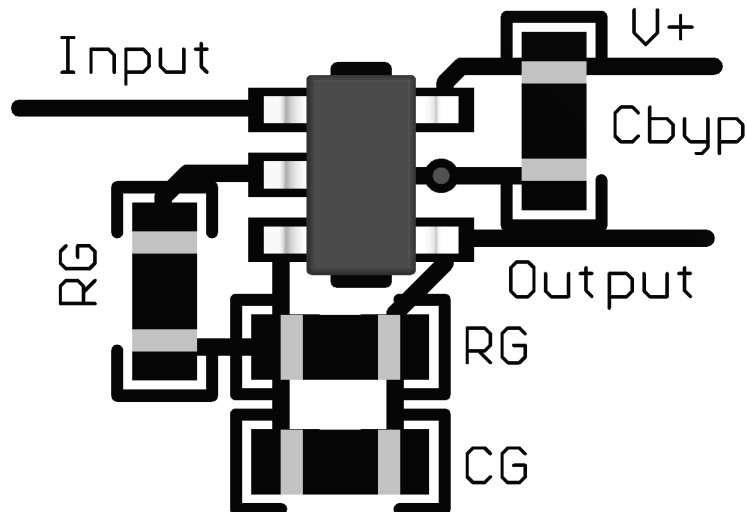

Figure 51. SOT-23 Noninverting Layout Example

11 Device and Documentation Support

11.1 Device Support

11.1.1 Development Support

LMV831 PSPICE Model, [SNOM049](#)

LMV832 PSPICE Model, [SNOM050](#)

LMV834 PSPICE Model, [SNOM038](#)

TINA-TI SPICE-Based Analog Simulation Program, <http://www.ti.com/tool/tina-ti>

TI Filterpro Software, <http://www.ti.com/tool/filterpro>

DIP Adapter Evaluation Module, <http://www.ti.com/tool/dip-adapter-evm>

TI Universal Operational Amplifier Evaluation Module, <http://www.ti.com/tool/opampevm>

11.2 Documentation Support

11.2.1 Related Documentation

For related documentation, see the following:

- *AN-028 Feedback Plots Define Op Amp AC Performance*, [SBOA015](#)
- *Circuit Board Layout Techniques*, [SLOA089](#)
- *Capacitive Load Drive Solution using an Isolation Resistor*, [TIPD128](#)
- *Handbook of Operational Amplifier Applications*, [SBOA092](#)
- *EMI-Hardened Operational Amplifiers for Robust Circuit Design*, [SNOA817](#)
- *AN-1698 A Specification for EMI Hardened Operational Amplifiers*, [SNOA497](#)
- *AN-1867 EMIRR Evaluation Boards for LMV831/LMV832/LMV834* (Boards are no longer available - for reference only), [SNOA530](#)

11.3 Related Links

The table below lists quick access links. Categories include technical documents, support and community resources, tools and software, and quick access to sample or buy.

Table 2. Related Links

PARTS	PRODUCT FOLDER	SAMPLE & BUY	TECHNICAL DOCUMENTS	TOOLS & SOFTWARE	SUPPORT & COMMUNITY
LMV831	Click here	Click here	Click here	Click here	Click here
LMV832	Click here	Click here	Click here	Click here	Click here
LMV834	Click here	Click here	Click here	Click here	Click here

11.4 Community Resources

The following links connect to TI community resources. Linked contents are provided "AS IS" by the respective contributors. They do not constitute TI specifications and do not necessarily reflect TI's views; see TI's [Terms of Use](#).

TI E2E™ Online Community *TI's Engineer-to-Engineer (E2E) Community*. Created to foster collaboration among engineers. At e2e.ti.com, you can ask questions, share knowledge, explore ideas and help solve problems with fellow engineers.

Design Support *TI's Design Support* Quickly find helpful E2E forums along with design support tools and contact information for technical support.

11.5 Trademarks

E2E is a trademark of Texas Instruments.

All other trademarks are the property of their respective owners.

11.6 Electrostatic Discharge Caution



These devices have limited built-in ESD protection. The leads should be shorted together or the device placed in conductive foam during storage or handling to prevent electrostatic damage to the MOS gates.

11.7 Glossary

[SLYZ022](#) — *TI Glossary*.

This glossary lists and explains terms, acronyms, and definitions.

12 Mechanical, Packaging, and Orderable Information

The following pages include mechanical, packaging, and orderable information. This information is the most current data available for the designated devices. This data is subject to change without notice and revision of this document. For browser-based versions of this data sheet, refer to the left-hand navigation.

PACKAGING INFORMATION

Orderable Device	Status (1)	Package Type	Package Drawing	Pins	Package Qty	Eco Plan (2)	Lead/Ball Finish (6)	MSL Peak Temp (3)	Op Temp (°C)	Device Marking (4/5)	Samples
LMV831MG/NOPB	ACTIVE	SC70	DCK	5	1000	Green (RoHS & no Sb/Br)	CU SN	Level-1-260C-UNLIM	-40 to 125	AFA	Samples
LMV831MGE/NOPB	ACTIVE	SC70	DCK	5	250	Green (RoHS & no Sb/Br)	CU SN	Level-1-260C-UNLIM	-40 to 125	AFA	Samples
LMV831MGX/NOPB	ACTIVE	SC70	DCK	5	3000	Green (RoHS & no Sb/Br)	CU SN	Level-1-260C-UNLIM	-40 to 125	AFA	Samples
LMV832MM/NOPB	ACTIVE	VSSOP	DGK	8	1000	Green (RoHS & no Sb/Br)	CU SN	Level-1-260C-UNLIM	-40 to 125	AU5A	Samples
LMV832MME/NOPB	ACTIVE	VSSOP	DGK	8	250	Green (RoHS & no Sb/Br)	CU SN	Level-1-260C-UNLIM	-40 to 125	AU5A	Samples
LMV832MMX/NOPB	ACTIVE	VSSOP	DGK	8	3500	Green (RoHS & no Sb/Br)	CU SN	Level-1-260C-UNLIM	-40 to 125	AU5A	Samples
LMV834MT/NOPB	ACTIVE	TSSOP	PW	14	94	Green (RoHS & no Sb/Br)	CU SN	Level-1-260C-UNLIM	-40 to 125	LMV834 MT	Samples
LMV834MTX/NOPB	ACTIVE	TSSOP	PW	14	2500	Green (RoHS & no Sb/Br)	CU SN	Level-1-260C-UNLIM	-40 to 125	LMV834 MT	Samples

(1) The marketing status values are defined as follows:

ACTIVE: Product device recommended for new designs.

LIFEBUY: TI has announced that the device will be discontinued, and a lifetime-buy period is in effect.

NRND: Not recommended for new designs. Device is in production to support existing customers, but TI does not recommend using this part in a new design.

PREVIEW: Device has been announced but is not in production. Samples may or may not be available.

OBSELETE: TI has discontinued the production of the device.

(2) Eco Plan - The planned eco-friendly classification: Pb-Free (RoHS), Pb-Free (RoHS Exempt), or Green (RoHS & no Sb/Br) - please check <http://www.ti.com/productcontent> for the latest availability information and additional product content details.

TBD: The Pb-Free/Green conversion plan has not been defined.

Pb-Free (RoHS): TI's terms "Lead-Free" or "Pb-Free" mean semiconductor products that are compatible with the current RoHS requirements for all 6 substances, including the requirement that lead not exceed 0.1% by weight in homogeneous materials. Where designed to be soldered at high temperatures, TI Pb-Free products are suitable for use in specified lead-free processes.

Pb-Free (RoHS Exempt): This component has a RoHS exemption for either 1) lead-based flip-chip solder bumps used between the die and package, or 2) lead-based die adhesive used between the die and leadframe. The component is otherwise considered Pb-Free (RoHS compatible) as defined above.

Green (RoHS & no Sb/Br): TI defines "Green" to mean Pb-Free (RoHS compatible), and free of Bromine (Br) and Antimony (Sb) based flame retardants (Br or Sb do not exceed 0.1% by weight in homogeneous material)

(3) MSL, Peak Temp. - The Moisture Sensitivity Level rating according to the JEDEC industry standard classifications, and peak solder temperature.

(4) There may be additional marking, which relates to the logo, the lot trace code information, or the environmental category on the device.

(5) Multiple Device Markings will be inside parentheses. Only one Device Marking contained in parentheses and separated by a "~" will appear on a device. If a line is indented then it is a continuation of the previous line and the two combined represent the entire Device Marking for that device.

(6) Lead/Ball Finish - Orderable Devices may have multiple material finish options. Finish options are separated by a vertical ruled line. Lead/Ball Finish values may wrap to two lines if the finish value exceeds the maximum column width.

Important Information and Disclaimer:The information provided on this page represents TI's knowledge and belief as of the date that it is provided. TI bases its knowledge and belief on information provided by third parties, and makes no representation or warranty as to the accuracy of such information. Efforts are underway to better integrate information from third parties. TI has taken and continues to take reasonable steps to provide representative and accurate information but may not have conducted destructive testing or chemical analysis on incoming materials and chemicals. TI and TI suppliers consider certain information to be proprietary, and thus CAS numbers and other limited information may not be available for release.

In no event shall TI's liability arising out of such information exceed the total purchase price of the TI part(s) at issue in this document sold by TI to Customer on an annual basis.

TAPE AND REEL INFORMATION

QUADRANT ASSIGNMENTS FOR PIN 1 ORIENTATION IN TAPE

*All dimensions are nominal

Device	Package Type	Package Drawing	Pins	SPQ	Reel Diameter (mm)	Reel Width W1 (mm)	A0 (mm)	B0 (mm)	K0 (mm)	P1 (mm)	W (mm)	Pin1 Quadrant
LMV831MG/NOPB	SC70	DCK	5	1000	178.0	8.4	2.25	2.45	1.2	4.0	8.0	Q3
LMV831MGE/NOPB	SC70	DCK	5	250	178.0	8.4	2.25	2.45	1.2	4.0	8.0	Q3
LMV831MGX/NOPB	SC70	DCK	5	3000	178.0	8.4	2.25	2.45	1.2	4.0	8.0	Q3
LMV832MM/NOPB	VSSOP	DGK	8	1000	178.0	12.4	5.3	3.4	1.4	8.0	12.0	Q1
LMV832MME/NOPB	VSSOP	DGK	8	250	178.0	12.4	5.3	3.4	1.4	8.0	12.0	Q1
LMV832MMX/NOPB	VSSOP	DGK	8	3500	330.0	12.4	5.3	3.4	1.4	8.0	12.0	Q1
LMV834MTX/NOPB	TSSOP	PW	14	2500	330.0	12.4	6.95	5.6	1.6	8.0	12.0	Q1

TAPE AND REEL BOX DIMENSIONS

*All dimensions are nominal

Device	Package Type	Package Drawing	Pins	SPQ	Length (mm)	Width (mm)	Height (mm)
LMV831MG/NOPB	SC70	DCK	5	1000	210.0	185.0	35.0
LMV831MGE/NOPB	SC70	DCK	5	250	210.0	185.0	35.0
LMV831MGX/NOPB	SC70	DCK	5	3000	210.0	185.0	35.0
LMV832MM/NOPB	VSSOP	DGK	8	1000	210.0	185.0	35.0
LMV832MME/NOPB	VSSOP	DGK	8	250	210.0	185.0	35.0
LMV832MMX/NOPB	VSSOP	DGK	8	3500	367.0	367.0	35.0
LMV834MTX/NOPB	TSSOP	PW	14	2500	367.0	367.0	35.0

DCK (R-PDSO-G5)

PLASTIC SMALL-OUTLINE PACKAGE

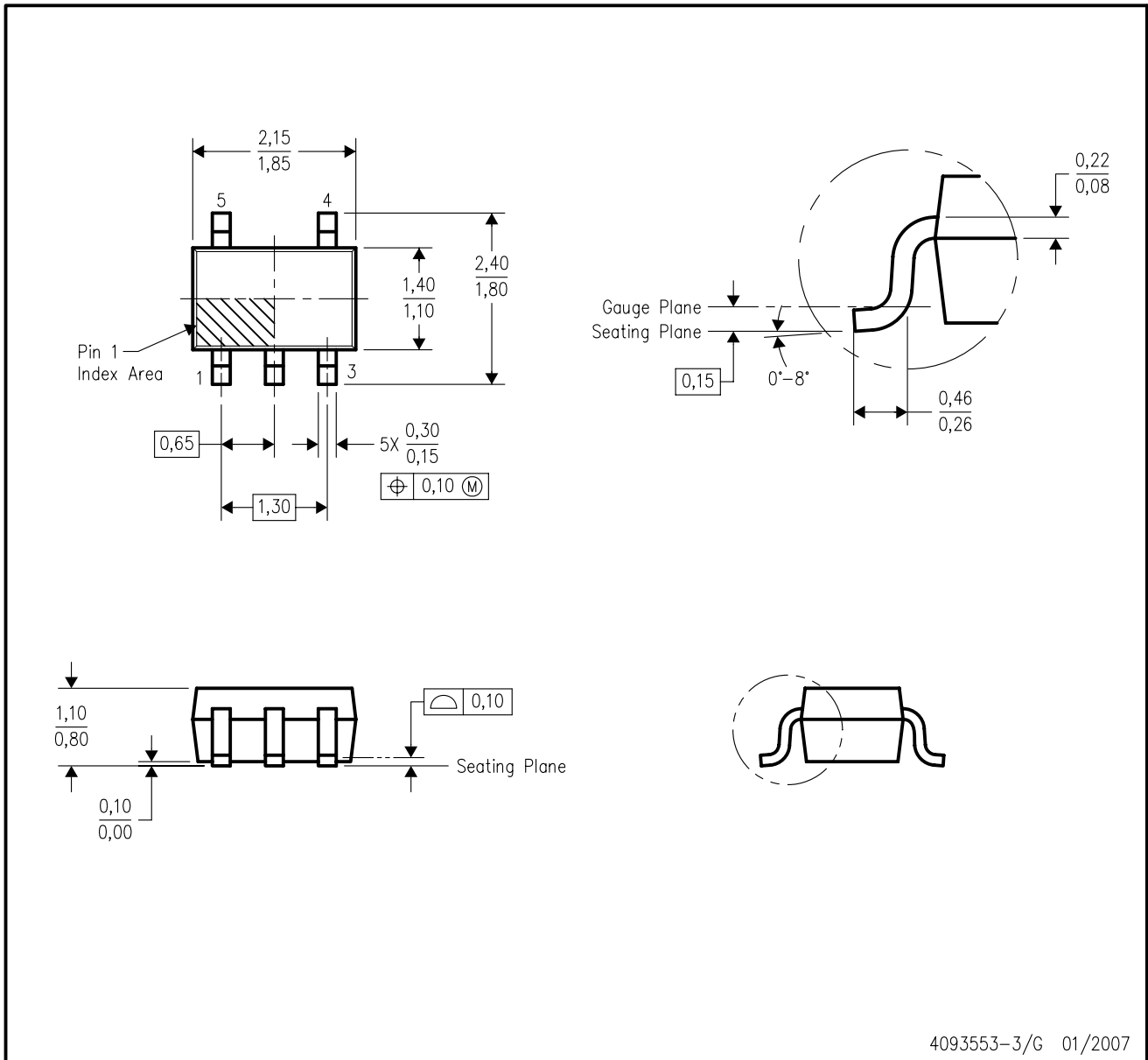

- NOTES:
- All linear dimensions are in millimeters.
 - This drawing is subject to change without notice.
 - Body dimensions do not include mold flash or protrusion. Mold flash and protrusion shall not exceed 0.15 per side.
 - Falls within JEDEC MO-203 variation AA.

DCK (R-PDSO-G5)

PLASTIC SMALL OUTLINE



- NOTES:
- A. All linear dimensions are in millimeters.
 - B. This drawing is subject to change without notice.
 - C. Customers should place a note on the circuit board fabrication drawing not to alter the center solder mask defined pad.
 - D. Publication IPC-7351 is recommended for alternate designs.
 - E. Laser cutting apertures with trapezoidal walls and also rounding corners will offer better paste release. Customers should contact their board assembly site for stencil design recommendations. Example stencil design based on a 50% volumetric metal load solder paste. Refer to IPC-7525 for other stencil recommendations.

DGK (S-PDSO-G8)

PLASTIC SMALL-OUTLINE PACKAGE

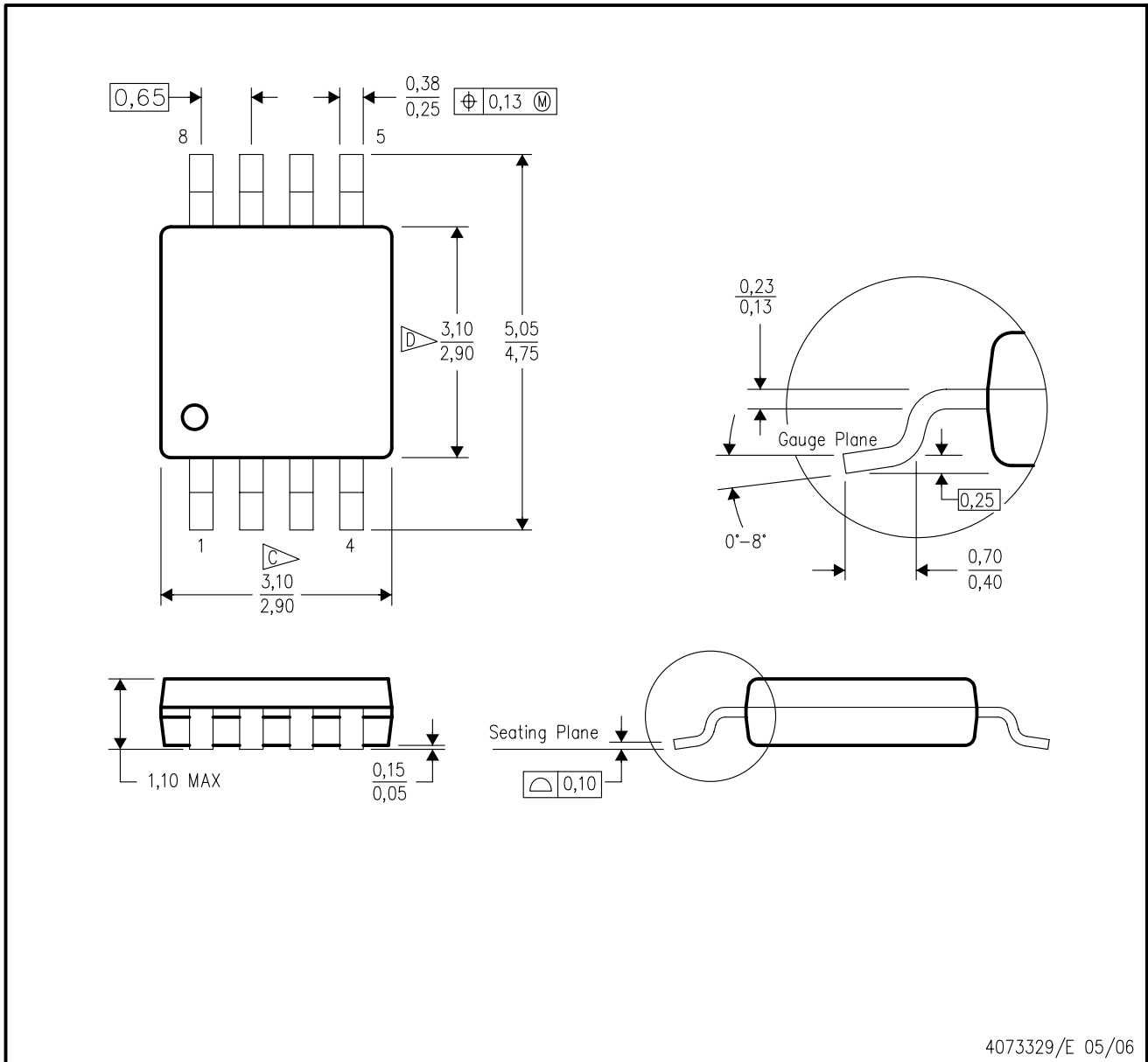

- NOTES:
- A. All linear dimensions are in millimeters.
 - B. This drawing is subject to change without notice.
 - C. Body length does not include mold flash, protrusions, or gate burrs. Mold flash, protrusions, or gate burrs shall not exceed 0.15 per end.
 - D. Body width does not include interlead flash. Interlead flash shall not exceed 0.50 per side.
 - E. Falls within JEDEC MO-187 variation AA, except interlead flash.

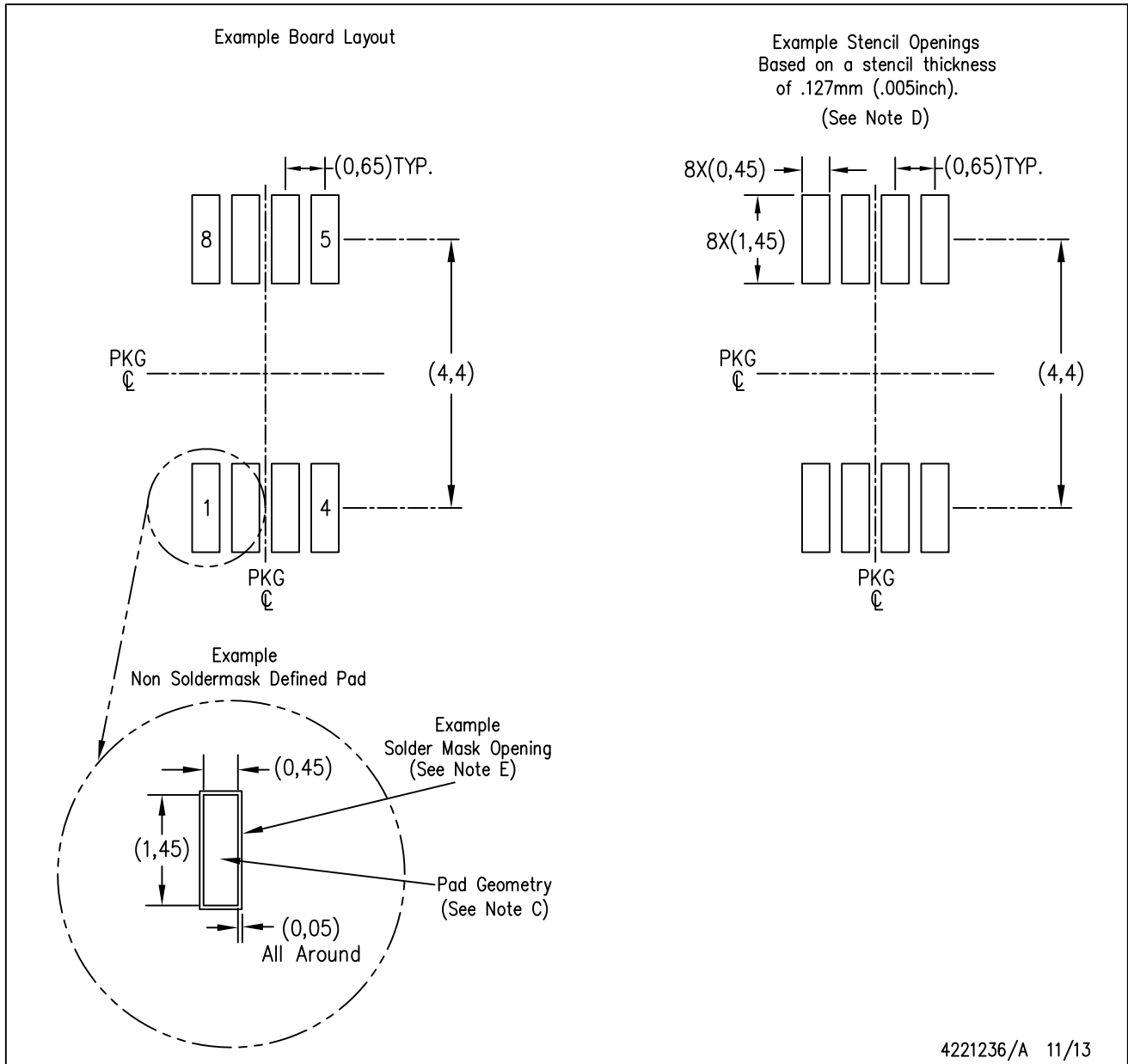

- NOTES:
- A. All linear dimensions are in millimeters.
 - B. This drawing is subject to change without notice.
 - C. Publication IPC-7351 is recommended for alternate designs.
 - D. Laser cutting apertures with trapezoidal walls and also rounding corners will offer better paste release. Customers should contact their board assembly site for stencil design recommendations. Refer to IPC-7525 for other stencil recommendations.
 - E. Customers should contact their board fabrication site for solder mask tolerances between and around signal pads.

IMPORTANT NOTICE

Texas Instruments Incorporated and its subsidiaries (TI) reserve the right to make corrections, enhancements, improvements and other changes to its semiconductor products and services per JESD46, latest issue, and to discontinue any product or service per JESD48, latest issue. Buyers should obtain the latest relevant information before placing orders and should verify that such information is current and complete. All semiconductor products (also referred to herein as "components") are sold subject to TI's terms and conditions of sale supplied at the time of order acknowledgment.

TI warrants performance of its components to the specifications applicable at the time of sale, in accordance with the warranty in TI's terms and conditions of sale of semiconductor products. Testing and other quality control techniques are used to the extent TI deems necessary to support this warranty. Except where mandated by applicable law, testing of all parameters of each component is not necessarily performed.

TI assumes no liability for applications assistance or the design of Buyers' products. Buyers are responsible for their products and applications using TI components. To minimize the risks associated with Buyers' products and applications, Buyers should provide adequate design and operating safeguards.

TI does not warrant or represent that any license, either express or implied, is granted under any patent right, copyright, mask work right, or other intellectual property right relating to any combination, machine, or process in which TI components or services are used. Information published by TI regarding third-party products or services does not constitute a license to use such products or services or a warranty or endorsement thereof. Use of such information may require a license from a third party under the patents or other intellectual property of the third party, or a license from TI under the patents or other intellectual property of TI.

Reproduction of significant portions of TI information in TI data books or data sheets is permissible only if reproduction is without alteration and is accompanied by all associated warranties, conditions, limitations, and notices. TI is not responsible or liable for such altered documentation. Information of third parties may be subject to additional restrictions.

Resale of TI components or services with statements different from or beyond the parameters stated by TI for that component or service voids all express and any implied warranties for the associated TI component or service and is an unfair and deceptive business practice. TI is not responsible or liable for any such statements.

Buyer acknowledges and agrees that it is solely responsible for compliance with all legal, regulatory and safety-related requirements concerning its products, and any use of TI components in its applications, notwithstanding any applications-related information or support that may be provided by TI. Buyer represents and agrees that it has all the necessary expertise to create and implement safeguards which anticipate dangerous consequences of failures, monitor failures and their consequences, lessen the likelihood of failures that might cause harm and take appropriate remedial actions. Buyer will fully indemnify TI and its representatives against any damages arising out of the use of any TI components in safety-critical applications.

In some cases, TI components may be promoted specifically to facilitate safety-related applications. With such components, TI's goal is to help enable customers to design and create their own end-product solutions that meet applicable functional safety standards and requirements. Nonetheless, such components are subject to these terms.

No TI components are authorized for use in FDA Class III (or similar life-critical medical equipment) unless authorized officers of the parties have executed a special agreement specifically governing such use.

Only those TI components which TI has specifically designated as military grade or "enhanced plastic" are designed and intended for use in military/aerospace applications or environments. Buyer acknowledges and agrees that any military or aerospace use of TI components which have **not** been so designated is solely at the Buyer's risk, and that Buyer is solely responsible for compliance with all legal and regulatory requirements in connection with such use.

TI has specifically designated certain components as meeting ISO/TS16949 requirements, mainly for automotive use. In any case of use of non-designated products, TI will not be responsible for any failure to meet ISO/TS16949.

Products

Audio	www.ti.com/audio
Amplifiers	amplifier.ti.com
Data Converters	dataconverter.ti.com
DLP® Products	www.dlp.com
DSP	dsp.ti.com
Clocks and Timers	www.ti.com/clocks
Interface	interface.ti.com
Logic	logic.ti.com
Power Mgmt	power.ti.com
Microcontrollers	microcontroller.ti.com
RFID	www.ti-rfid.com
OMAP Applications Processors	www.ti.com/omap
Wireless Connectivity	www.ti.com/wirelessconnectivity

Applications

Automotive and Transportation	www.ti.com/automotive
Communications and Telecom	www.ti.com/communications
Computers and Peripherals	www.ti.com/computers
Consumer Electronics	www.ti.com/consumer-apps
Energy and Lighting	www.ti.com/energy
Industrial	www.ti.com/industrial
Medical	www.ti.com/medical
Security	www.ti.com/security
Space, Avionics and Defense	www.ti.com/space-avionics-defense
Video and Imaging	www.ti.com/video

TI E2E Community

e2e.ti.com