

# IRF8714PbF

HEXFET® Power MOSFET

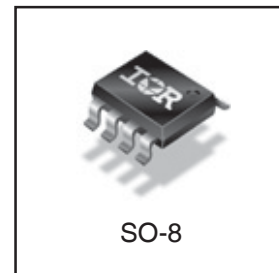
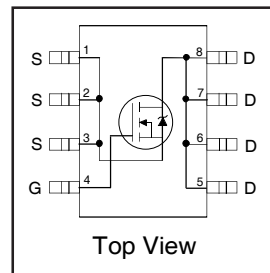
## Applications

- Control MOSFET of Sync-Buck Converters used for Notebook Processor Power
- Control MOSFET for Isolated DC-DC Converters in Networking Systems

<b>V<sub>DSS</sub></b>	<b>R<sub>DS(on)</sub> max</b>	<b>Q<sub>g</sub></b>
<b>30V</b>	<b>8.7mΩ @ V<sub>GS</sub> = 10V</b>	<b>8.1nC</b>

## Benefits

- Very Low Gate Charge
- Very Low R<sub>DS(on)</sub> at 4.5V V<sub>GS</sub>
- Ultra-Low Gate Impedance
- Fully Characterized Avalanche Voltage and Current
- 20V V<sub>GS</sub> Max. Gate Rating
- 100% tested for R<sub>g</sub>
- Lead-Free



## Description

The IRF8714PbF incorporates the latest HEXFET Power MOSFET Silicon Technology into the industry standard SO-8 package. The IRF8714PbF has been optimized for parameters that are critical in synchronous buck operation including R<sub>ds(on)</sub> and gate charge to reduce both conduction and switching losses. The reduced total losses make this product ideal for high efficiency DC-DC converters that power the latest generation of processors for Notebook and Netcom applications.

## Absolute Maximum Ratings

	Parameter	Max.	Units
V <sub>DS</sub>	Drain-to-Source Voltage	30	V
V <sub>GS</sub>	Gate-to-Source Voltage	± 20	
I <sub>D</sub> @ T <sub>A</sub> = 25°C	Continuous Drain Current, V <sub>GS</sub> @ 10V	14	A
I <sub>D</sub> @ T <sub>A</sub> = 70°C	Continuous Drain Current, V <sub>GS</sub> @ 10V	11	
I <sub>DM</sub>	Pulsed Drain Current ①	110	
P <sub>D</sub> @ T <sub>A</sub> = 25°C	Power Dissipation	2.5	W
P <sub>D</sub> @ T <sub>A</sub> = 70°C	Power Dissipation	1.6	
	Linear Derating Factor	0.02	W/°C
T <sub>J</sub>	Operating Junction and	-55 to + 150	°C
T <sub>STG</sub>	Storage Temperature Range		

## Thermal Resistance

	Parameter	Typ.	Max.	Units
R <sub>θJL</sub>	Junction-to-Drain Lead ⑤	—	20	°C/W
R <sub>θJA</sub>	Junction-to-Ambient ④⑤	—	50	

Notes ① through ⑤ are on page 9

## Static @ T<sub>J</sub> = 25°C (unless otherwise specified)

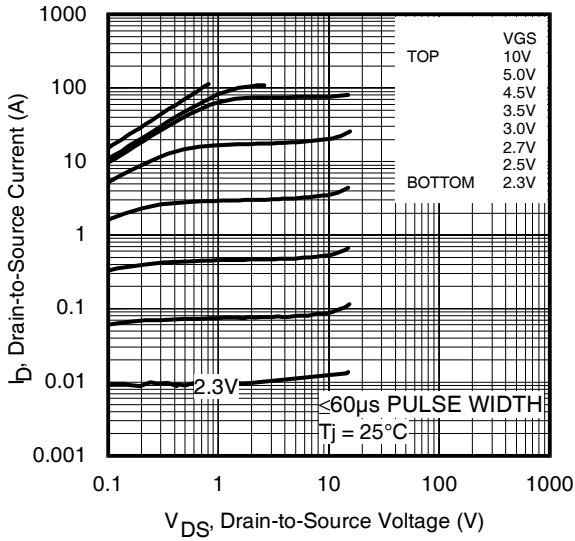
	Parameter	Min.	Typ.	Max.	Units	Conditions
BV <sub>DSS</sub>	Drain-to-Source Breakdown Voltage	30	—	—	V	V <sub>GS</sub> = 0V, I <sub>D</sub> = 250μA
ΔBV <sub>DSS</sub> /ΔT <sub>J</sub>	Breakdown Voltage Temp. Coefficient	—	0.021	—	V/°C	Reference to 25°C, I <sub>D</sub> = 1mA
R <sub>DS(on)</sub>	Static Drain-to-Source On-Resistance	—	7.1	8.7	mΩ	V <sub>GS</sub> = 10V, I <sub>D</sub> = 14A ③
		—	10.9	13		V <sub>GS</sub> = 4.5V, I <sub>D</sub> = 11A ③
V <sub>GS(th)</sub>	Gate Threshold Voltage	1.35	1.80	2.35	V	V <sub>DS</sub> = V <sub>GS</sub> , I <sub>D</sub> = 25μA
ΔV <sub>GS(th)</sub>	Gate Threshold Voltage Coefficient	—	-6.0	—	mV/°C	V <sub>DS</sub> = V <sub>GS</sub> , I <sub>D</sub> = 25μA
I <sub>DSS</sub>	Drain-to-Source Leakage Current	—	—	1.0	μA	V <sub>DS</sub> = 24V, V <sub>GS</sub> = 0V
		—	—	150		V <sub>DS</sub> = 24V, V <sub>GS</sub> = 0V, T <sub>J</sub> = 125°C
I <sub>GSS</sub>	Gate-to-Source Forward Leakage	—	—	100	nA	V <sub>GS</sub> = 20V
	Gate-to-Source Reverse Leakage	—	—	-100		V <sub>GS</sub> = -20V
g <sub>fs</sub>	Forward Transconductance	71	—	—	S	V <sub>DS</sub> = 15V, I <sub>D</sub> = 11A
Q <sub>g</sub>	Total Gate Charge	—	8.1	12	nC	V <sub>DS</sub> = 15V V <sub>GS</sub> = 4.5V I <sub>D</sub> = 11A See Figs. 15 & 16
Q <sub>gs1</sub>	Pre-V <sub>th</sub> Gate-to-Source Charge	—	1.9	—		
Q <sub>gs2</sub>	Post-V <sub>th</sub> Gate-to-Source Charge	—	1.0	—		
Q <sub>gd</sub>	Gate-to-Drain Charge	—	3.0	—		
Q <sub>godr</sub>	Gate Charge Overdrive	—	2.2	—		
Q <sub>sw</sub>	Switch Charge (Q <sub>gs2</sub> + Q <sub>gd</sub> )	—	4.0	—		
Q <sub>oss</sub>	Output Charge	—	4.8	—	nC	V <sub>DS</sub> = 16V, V <sub>GS</sub> = 0V
R <sub>g</sub>	Gate Resistance	—	1.6	2.6	Ω	
t <sub>d(on)</sub>	Turn-On Delay Time	—	10	—	ns	V <sub>DD</sub> = 15V, V <sub>GS</sub> = 4.5V I <sub>D</sub> = 11A R <sub>G</sub> = 1.8Ω See Fig. 18
t <sub>r</sub>	Rise Time	—	9.9	—		
t <sub>d(off)</sub>	Turn-Off Delay Time	—	11	—		
t <sub>f</sub>	Fall Time	—	5.0	—		
C <sub>iss</sub>	Input Capacitance	—	1020	—	pF	V <sub>GS</sub> = 0V V <sub>DS</sub> = 15V f = 1.0MHz
C <sub>oss</sub>	Output Capacitance	—	220	—		
C <sub>rss</sub>	Reverse Transfer Capacitance	—	110	—		

## Avalanche Characteristics

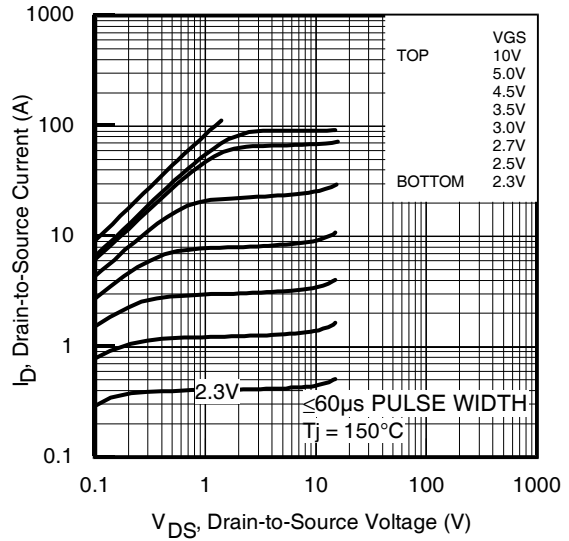
	Parameter	Typ.	Max.	Units
E <sub>AS</sub>	Single Pulse Avalanche Energy ②	—	65	mJ
I <sub>AR</sub>	Avalanche Current ①	—	11	A

## Diode Characteristics

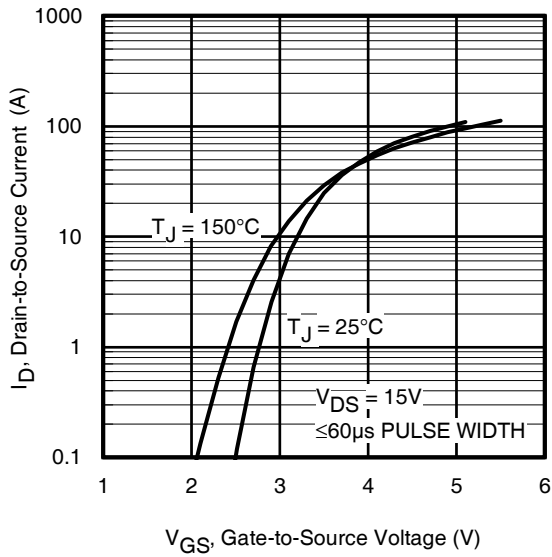
	Parameter	Min.	Typ.	Max.	Units	Conditions
I <sub>S</sub>	Continuous Source Current (Body Diode)	—	—	3.1	A	MOSFET symbol showing the integral reverse p-n junction diode.
I <sub>SM</sub>	Pulsed Source Current (Body Diode) ①	—	—	110		
V <sub>SD</sub>	Diode Forward Voltage	—	—	1.0	V	T <sub>J</sub> = 25°C, I <sub>S</sub> = 11A, V <sub>GS</sub> = 0V ③
t <sub>rr</sub>	Reverse Recovery Time	—	14	21	ns	T <sub>J</sub> = 25°C, I <sub>F</sub> = 11A, V <sub>DD</sub> = 15V
Q <sub>rr</sub>	Reverse Recovery Charge	—	15	23	nC	di/dt = 300A/μs ③
t <sub>on</sub>	Forward Turn-On Time	Intrinsic turn-on time is negligible (turn-on is dominated by LS+LD)				



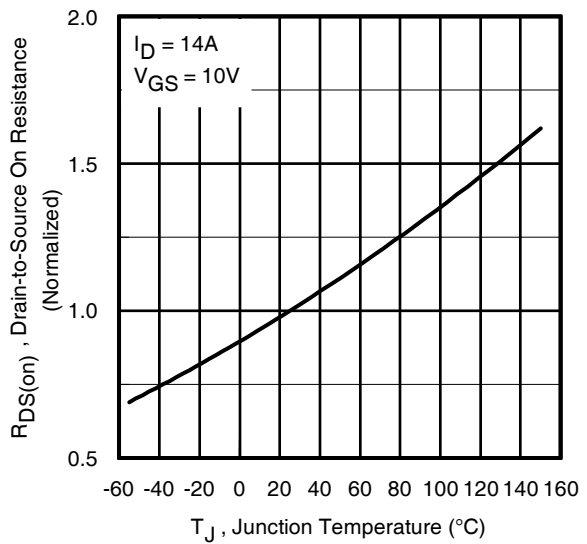
**Fig 1.** Typical Output Characteristics



**Fig 2.** Typical Output Characteristics



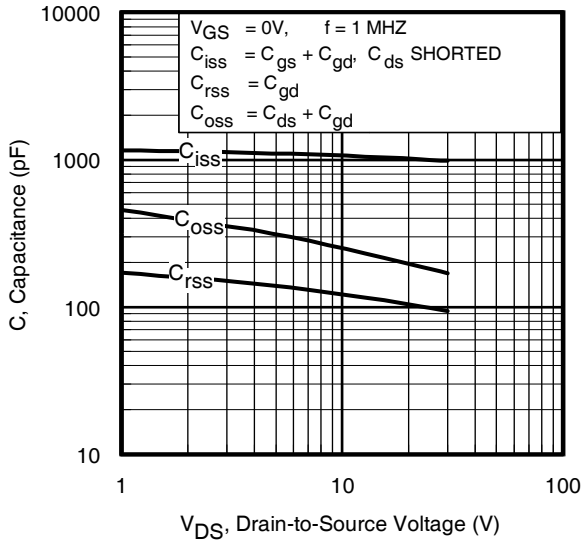
**Fig 3.** Typical Transfer Characteristics



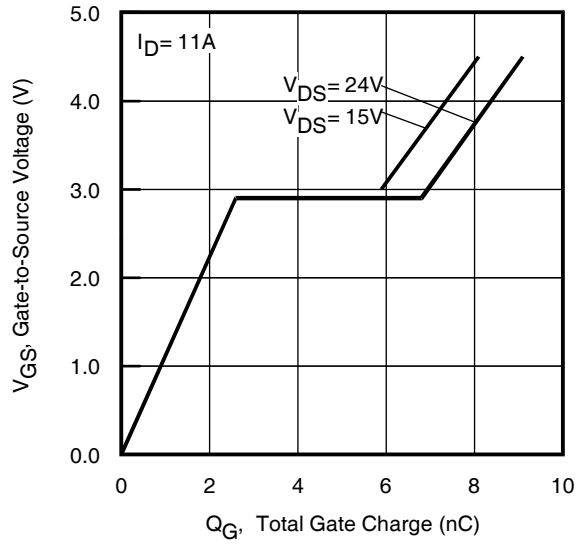
**Fig 4.** Normalized On-Resistance vs. Temperature

# IRF8714PbF

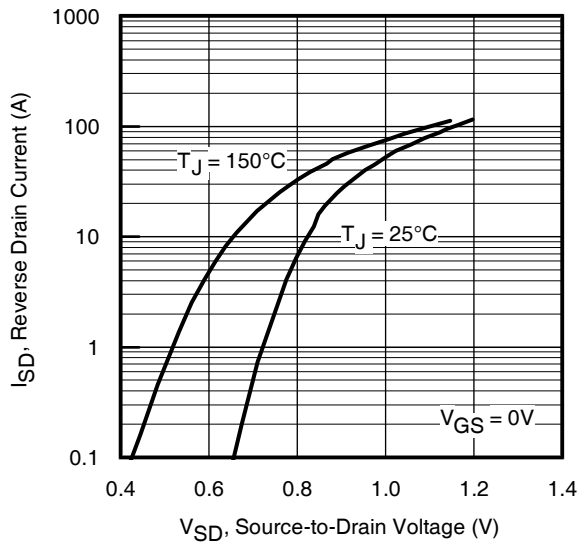
International  
**IR** Rectifier



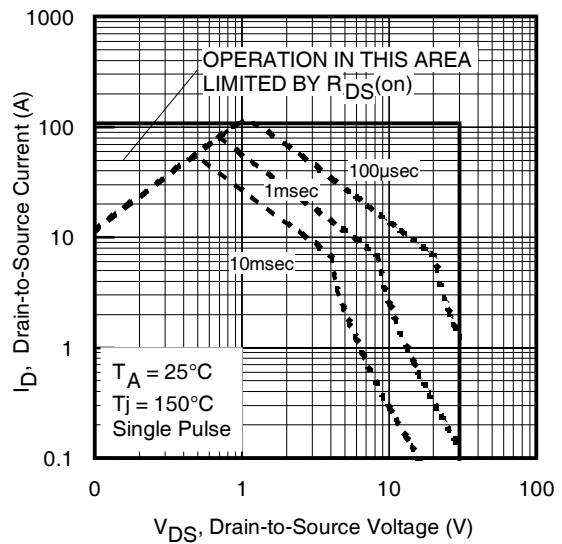
**Fig 5.** Typical Capacitance vs. Drain-to-Source Voltage



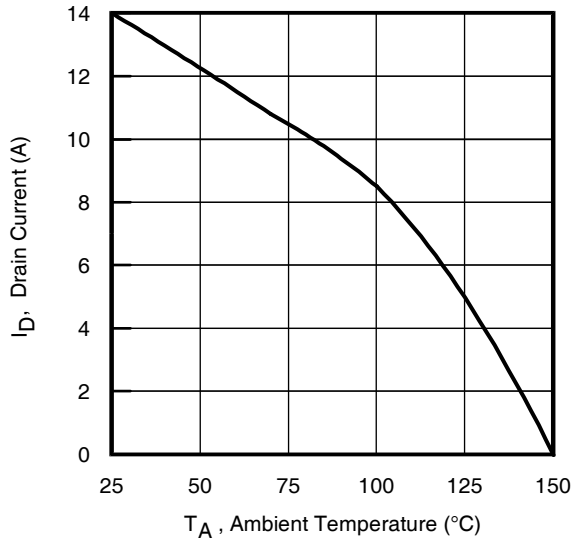
**Fig 6.** Typical Gate Charge Vs. Gate-to-Source Voltage



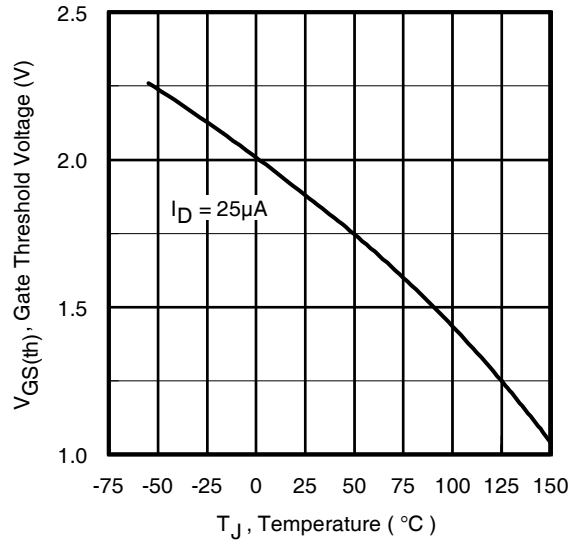
**Fig 7.** Typical Source-Drain Diode Forward Voltage



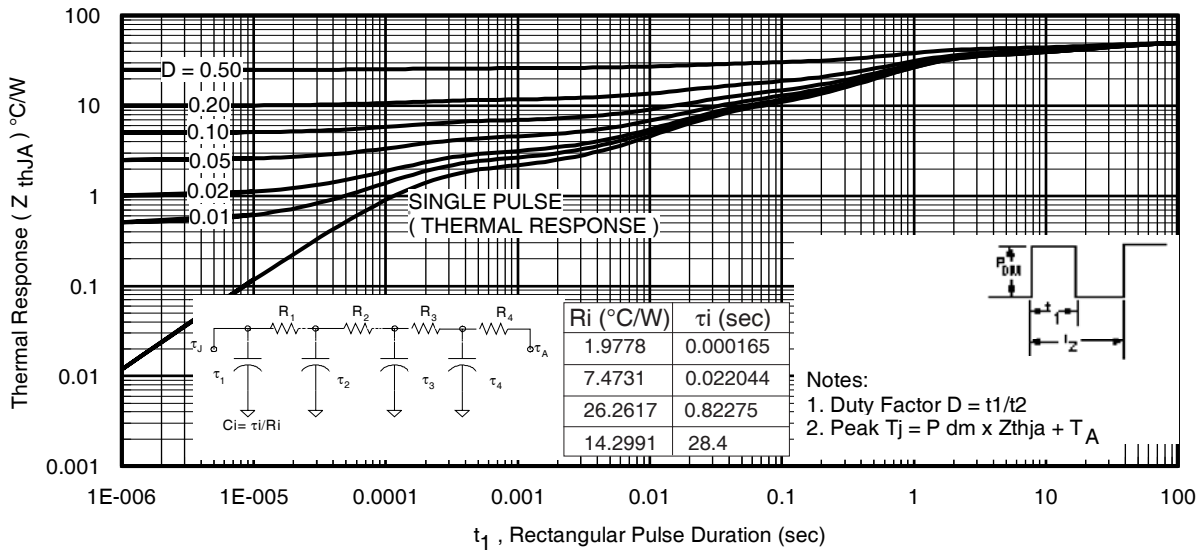
**Fig 8.** Maximum Safe Operating Area



**Fig 9.** Maximum Drain Current vs. Ambient Temperature



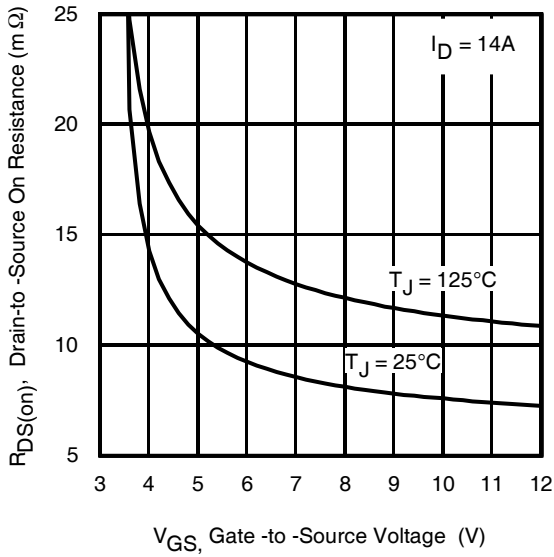
**Fig 10.** Threshold Voltage vs. Temperature



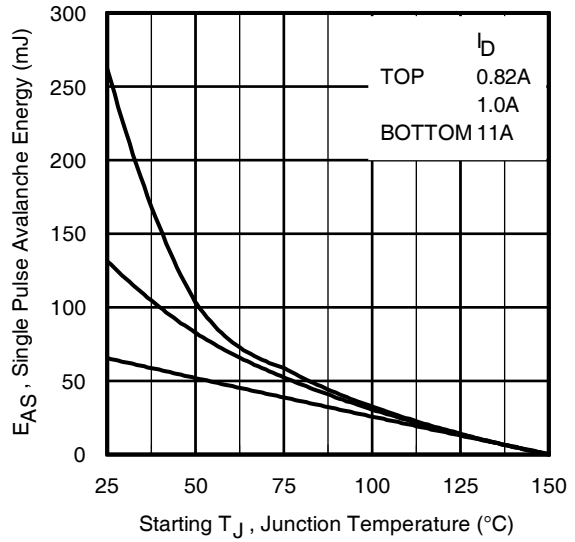
**Fig 11.** Maximum Effective Transient Thermal Impedance, Junction-to-Ambient

# IRF8714PbF

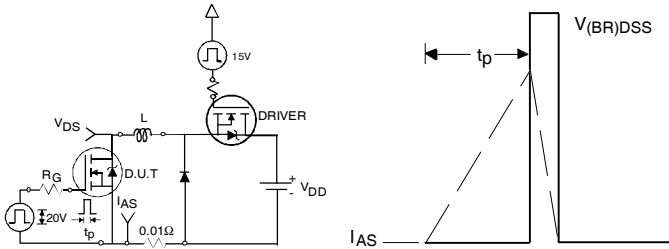
International  
**IR** Rectifier



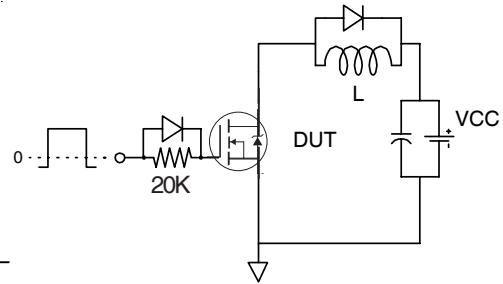
**Fig 12.** On-Resistance vs. Gate Voltage



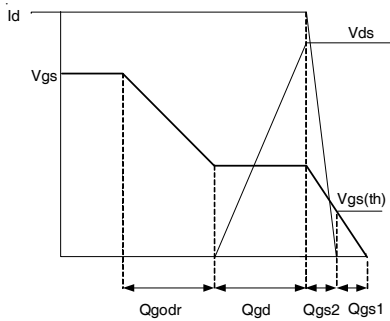
**Fig 13.** Maximum Avalanche Energy vs. Drain Current



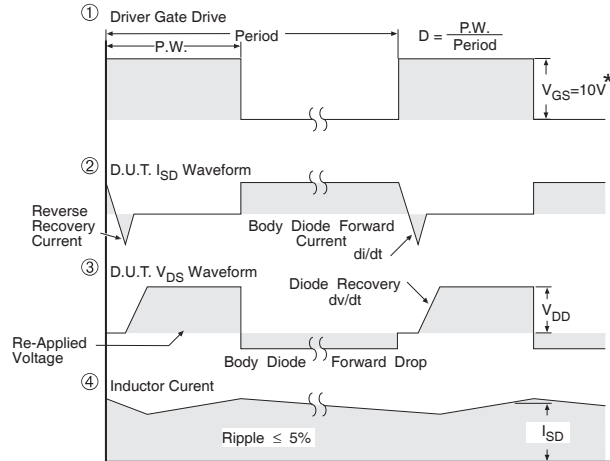
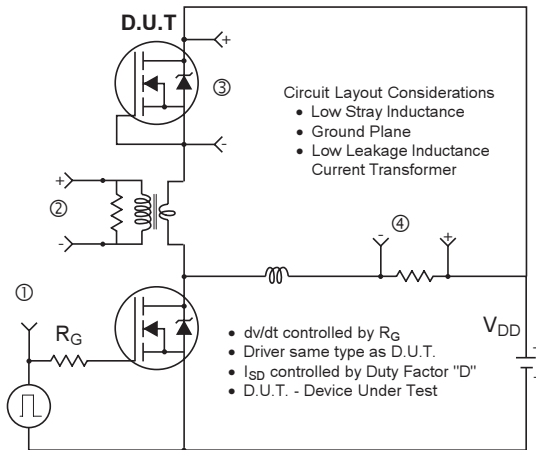
**Fig 14.** Unclamped Inductive Test Circuit and Waveform



**Fig 15.** Gate Charge Test Circuit

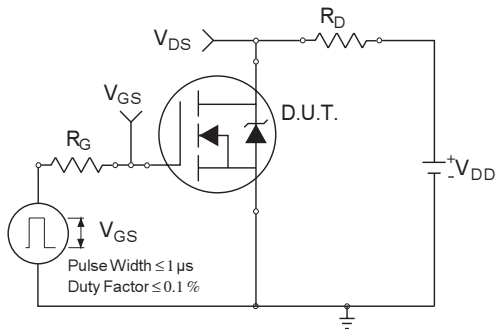


**Fig 16.** Gate Charge Waveform

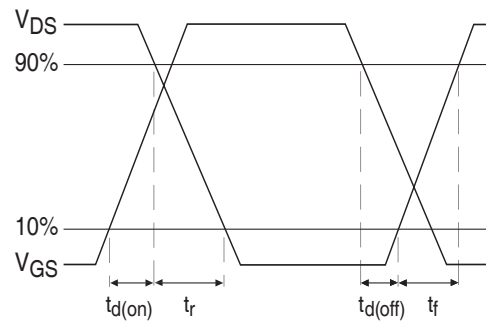


\*  $V_{GS} = 5V$  for Logic Level Devices

**Fig 17. Peak Diode Recovery  $dv/dt$  Test Circuit for N-Channel HEXFET® Power MOSFETS**



**Fig 18a. Switching Time Test Circuit**



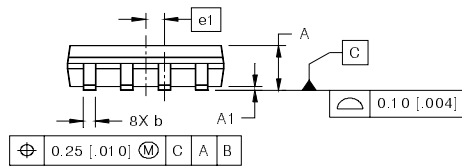
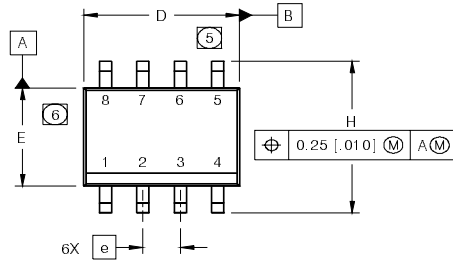
**Fig 18b. Switching Time Waveforms**

# IRF8714PbF

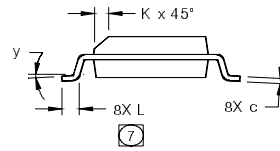
## SO-8 Package Outline

International  
**IR** Rectifier

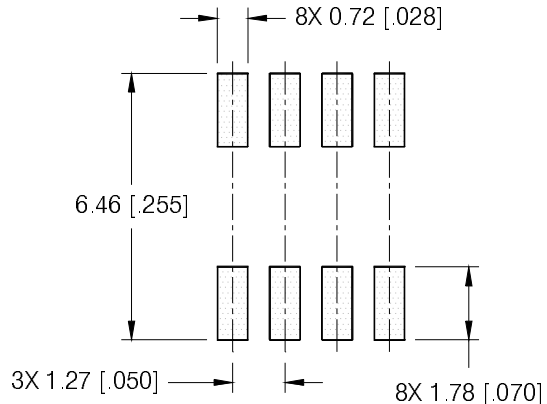
Dimensions are shown in millimeters (inches)



DIM	INCHES		MILLIMETERS	
	MIN	MAX	MIN	MAX
A	.0532	.0688	1.35	1.75
A1	.0040	.0098	0.10	0.25
b	.013	.020	0.33	0.51
c	.0075	.0098	0.19	0.25
D	.189	.1968	4.80	5.00
E	.1497	.1574	3.80	4.00
e	.050 BASIC		1.27 BASIC	
e 1	.025 BASIC		0.635 BASIC	
H	.2284	.2440	5.80	6.20
K	.0099	.0196	0.25	0.50
L	.016	.050	0.40	1.27
y	0°	8°	0°	8°



### FOOTPRINT

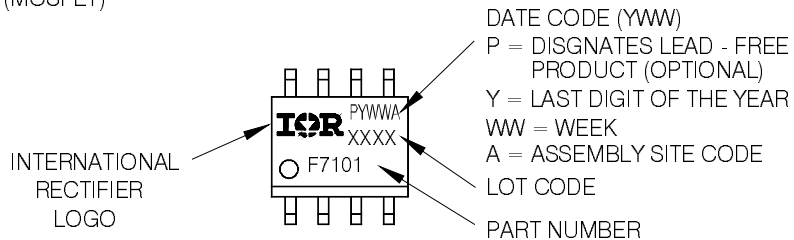


#### NOTES:

1. DIMENSIONING & TOLERANCING PER ASME Y14.5M-1994.
2. CONTROLLING DIMENSION: MILLIMETER
3. DIMENSIONS ARE SHOWN IN MILLIMETERS [INCHES].
4. OUTLINE CONFORMS TO JEDEC OUTLINE MS-012AA.
- ⑤ DIMENSION DOES NOT INCLUDE MOLD PROTRUSIONS. MOLD PROTRUSIONS NOT TO EXCEED 0.15 [0.006].
- ⑥ DIMENSION DOES NOT INCLUDE MOLD PROTRUSIONS. MOLD PROTRUSIONS NOT TO EXCEED 0.25 [0.010].
- ⑦ DIMENSION IS THE LENGTH OF LEAD FOR SOLDERING TO A SUBSTRATE.

## SO-8 Part Marking Information

EXAMPLE: THIS IS AN IRF7101 (MOSFET)

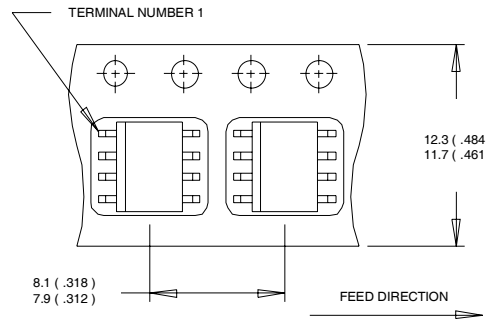


Note: For the most current drawing please refer to IR website at <http://www.irf.com/package>

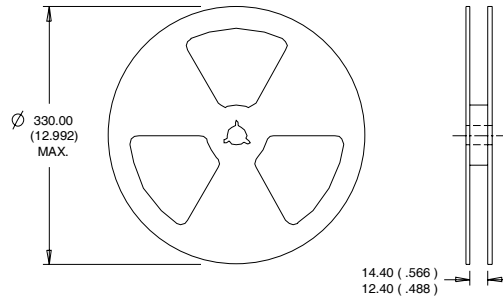


## SO-8 Tape and Reel

Dimensions are shown in millimeters (inches)



- NOTES:
1. CONTROLLING DIMENSION : MILLIMETER.
  2. ALL DIMENSIONS ARE SHOWN IN MILLIMETERS(INCHES).
  3. OUTLINE CONFORMS TO EIA-481 & EIA-541.



- NOTES:
1. CONTROLLING DIMENSION : MILLIMETER.
  2. OUTLINE CONFORMS TO EIA-481 & EIA-541.

**Notes:**

- ① Repetitive rating; pulse width limited by max. junction temperature.
- ② Starting  $T_J = 25^\circ\text{C}$ ,  $L = 1.1\text{mH}$ ,  $R_G = 25\Omega$ ,  $I_{AS} = 11\text{A}$ .
- ③ Pulse width  $\leq 400\mu\text{s}$ ; duty cycle  $\leq 2\%$ .
- ④ When mounted on 1 inch square copper board.
- ⑤  $R_\theta$  is measured at  $T_J$  of approximately  $90^\circ\text{C}$ .

**Note:** For the most current drawing please refer to IR website at <http://www.irf.com/package>

Data and specifications subject to change without notice.  
 This product has been designed and qualified for the Consumer market.  
 Qualification Standards can be found on IR's Web site.