

**Serial LED Driver with Filtered PWM and 32-Step S<sup>2</sup>C Dimming Control**

**General Description**

The AAT1402 is a step-up single channel LED driver with an input voltage range of 2.7V to 5.5V. The wide input voltage, small solution size, advanced dimming features and high efficiency are suitable for LED backlight solutions for single cell Li-ion based equipment. A precision high voltage current sink maintains the maximum LED current set by an external resistor from 10 to 31mA to drive 8 series connected LEDs. The high switching frequency supports ultra-small, low-cost filtering components.

Two dimming controls are available: 32 dimming steps using S<sup>2</sup>Cwire and filtered PWM control. The frequency range of the PWM dimming extends up to 100kHz, eliminating audible noise and making the AAT1402 suitable for CABC (Content Adaptive Brightness Control) applications.

The AAT1402 includes over-temperature protection and programmable over-voltage protection. The device is available in a 10-pin wafer-level chip scale package (WLCSP) and is rated over the -40°C to +85°C temperature range.

**Features**

- Input Voltage Range: 2.7 to 5.5V
- Drives up to 37V with 8 Series LEDs at 31mA
- 1MHz Switching Frequency Allows Small External Components
- Up to 83% Efficiency with 10µH Inductor
- Dimming Control Options:
  - 32 Steps - S<sup>2</sup>Cwire Single Wire Interface
  - Filtered PWM
- Low Operating Current at 2.3mA
- Shutdown Current < 1µA
- Over-Voltage Protection for Open-LED Faults
- Over-Temperature Protection
- Ultra Small, Low Profile, 10-pin 1.55 x 1.15mm WLCSP Package

**Applications**

- Digital Still Cameras (DSCs)
- Mobile Handsets
- Netbooks and Notebooks
- Portable Media Players
- White LED Drivers

**Typical Application Circuit**

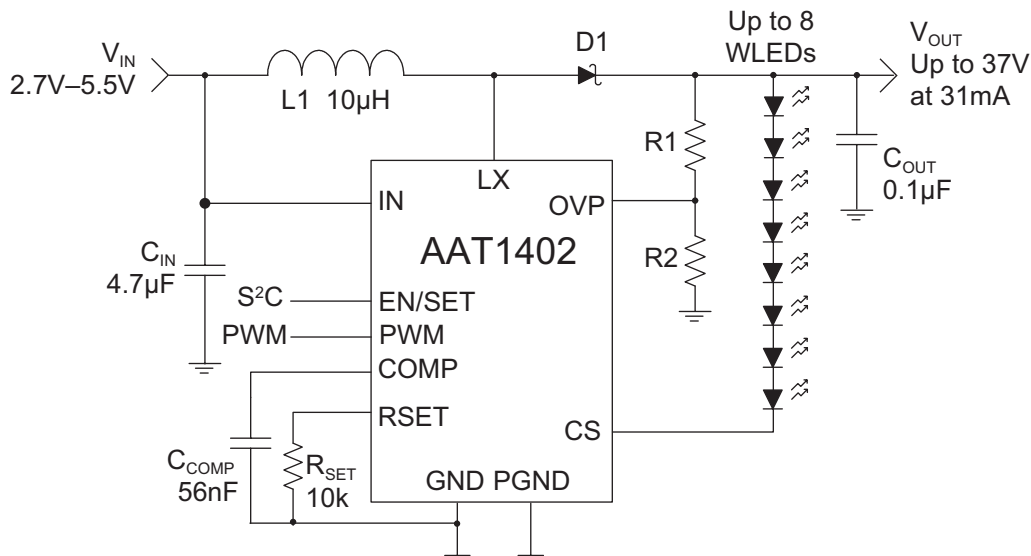

**Serial LED Driver with Filtered PWM and 32-Step S2C Dimming Control****Pin Descriptions**

Pin #	Symbol	Function
A1	LX	Switching node of boost converter. Connect an inductor between LX and input supply (VIN); Schottky rectifier anode is connected between LX pin while cathode is connected to output capacitor.
A2	IN	Supply input for the IC. Connect a 4.7 $\mu$ F, 6.3V/10V ceramic capacitor from this pin to GND.
A3	EN/SET	Enable on/off control and S <sup>2</sup> Cwire interface input.
B1	PGND	Power ground pin.
B3	PWM	Input PWM pin. Pull high to disable the PWM dimming feature.
C1	GND	Ground pin.
C3	COMP	Compensation pin. Connect a capacitor from this pin to GND. Compensation components vary with L and C values used. See table in applications section.
D1	CS	Connect to the cathode of the last diode of the LEDs string.
D2	RSET	Connect a resistor to GND to set maximum LED current. Drive this input with a resistor connected to an analog voltage to dim the LED.
D3	OVP	Feedback pin for over-voltage protection.

**Pin Configuration**

**WLCSP-10**  
**(1.1 x 1.5mm)**  
**(Top View)**

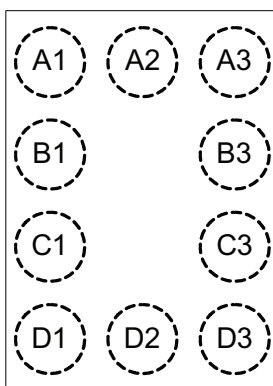

**Serial LED Driver with Filtered PWM and 32-Step S2C Dimming Control****Absolute Maximum Ratings<sup>1</sup>**

Symbol	Description	Value	Units
$V_{IN}$	IN to GND, PGND	-0.3 to 6.0	V
$V_{LX}$	LX to GND, PGND	-0.3 to 44	V
$V_{CS}$	SINK to GND, PGND	-0.3 to 35	V
$V_{EN/SET}, V_{PWM}, V_{RSET}, V_{COMP}, V_{OVP}$	EN/SET, PWM, RSET, COMP, OVP to GND/PGND	-0.3 to IN +0.3	V

**Thermal Information<sup>2</sup>**

Symbol	Description	Value	Units
$\Theta_{JA}$	Thermal Resistance	122	°C/W
$P_D$	Maximum Power Dissipation	820	mW
$T_J$	Maximum Junction Operating Temperature	-40 to +155	°C
$T_{LEAD}$	Maximum Soldering Temperature (at leads, 10 sec)	300	

**Recommended Operating Conditions**

Symbol	Description	Min	Typ	Max	Units
$V_{IN}$	Input Supply Voltage	2.7		5.5	V
$V_{OUT}$	Boosted Output Voltage	$V_{IN} + 3V$		$V_{OUT}^3$	V
L1	Inductor Value	4.7	10	22	μH
$F_{PWM-F}$	Input Filtered PWM Frequency	100		100,000	Hz
$T_{AMB}$	Ambient Temperature Range	- 40		85	°C

1. Stresses above those listed in Absolute Maximum Ratings may cause permanent damage to the device. Functional operation at conditions other than the operating conditions specified is not implied. Only one Absolute Maximum Rating should be applied at any one time.

2. Mounted on an FR4 board.

3. Check Electrical Characteristics.

# DATA SHEET

# AAT1402

## Serial LED Driver with Filtered PWM and 32-Step S2C Dimming Control

### Electrical Characteristics<sup>1</sup>

$V_{IN} = 3.6V$ ,  $C_{IN} = 4.7\mu F$ ,  $C_{OUT} = 0.1\mu F$ ,  $L = 10\mu H$ ,  $R_{SET} = 10K\Omega$ ,  $T_A = -40^\circ C$  to  $85^\circ C$  unless otherwise noted. Typical values are at  $T_A = 25^\circ C$ .

Symbol	Description	Conditions	Min	Typ	Max	Units
$V_{IN}$	Input Voltage Range		2.7		5.5	V
$V_{OUT}$	Maximum Output Voltage				37	V
$I_Q$	Quiescent Supply Current	$V_{ENSET} = V_{IN}$		430	700	$\mu A$
$I_{SHDN}$	Input Shutdown Current	$V_{ENSET} = 0V$			1	$\mu A$
$I_{QSW}$	Input Switching Current	$V_{ENSET} = V_{IN}$		2.3		mA
$R_{DS(ON)}$	NMOS On-Resistance	$T_A = 25^\circ C$		650		m $\Omega$
$\eta$	Maximum Efficiency	$I_{OUT} = 31mA$		83		%
$F_{osc}$	Switching Frequency	$T_A = 25^\circ C$		1		MHz
$T_{SS}$	Soft-Start Time	$V_{ENSET} = V_{IN}$ to 95% of output regulation, $C_{COMP} = 56nF$		5		ms
$D_{MAX}$	Maximum Duty Cycle		94.0			%
$V_{OVP-T}$	OUT Over-Voltage Protection Threshold	$V_{OVP}$ rising	1.1	1.2	1.3	V
$V_{OVPH}$	Over-Voltage Protection Hysteresis			75		mV
$T_{SD}$	Over-Temperature Shutdown Threshold			155		$^\circ C$
$T_{HYS}$	Over-Temperature Shutdown Hysteresis			15		$^\circ C$
$V_{CS}$	Current Sink Voltage	$I_{OUT} = 31mA$		500		mV
$I_{CS(ACC)}$	Current Sink Accuracy	$R_{SET} = 10K\Omega$	27.9	31.0	34.1	mA
$V_{RSET}$	RSET Voltage	$R_{SET} = 10K\Omega$		1.206		V
<b>EN/SET</b>						
$V_{EN/SET(L)}$	EN/SET	$V_{IN} = 2.7V$ to $5.5V$			0.4	V
$V_{EN/SET(H)}$	EN/SET	$V_{IN} = 2.7V$ to $5.5V$	1.4			V
$t_{EN/SET(LOW)}$	EN/SET Input Low Time		0.3		75	$\mu s$
$t_{EN/SET(HI\_MIN)}$	EN/SET Minimum High Time		100			ns
$t_{EN/SET(HIMAX)}$	EN/SET Maximum High Time				75	$\mu s$
$t_{EN/SET(OFF)}$	EN/SET Input Off Timeout				500	$\mu s$
$t_{EN/SET(LAT)}$	EN/SET Latch Timeout				500	$\mu s$
$I_{EN/SET(LK)}$	EN Input Leakage	$V_{ENSET} = 5V$ , $V_{IN} = 5V$	-1		1	$\mu A$
<b>PWM</b>						
$V_{PWM(L)}$	Logic Threshold Low				0.4	V
$V_{PWM(H)}$	Logic Threshold High		1.4			V
$I_{PWM(LK)}$	PWM Input Leakage	$V_{PWM} = 5V$ , $V_{IN} = 5V$	-1		1	$\mu A$

## Serial LED Driver with Filtered PWM and 32-Step S<sup>2</sup>C Dimming Control

### Typical Characteristics

**Quiescent Current vs. Input Voltage**

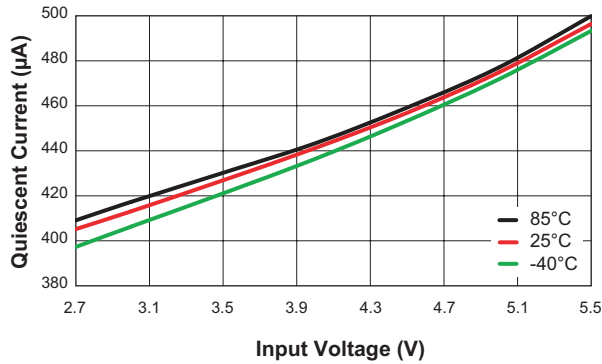

**Shutdown Current vs. Input Voltage**

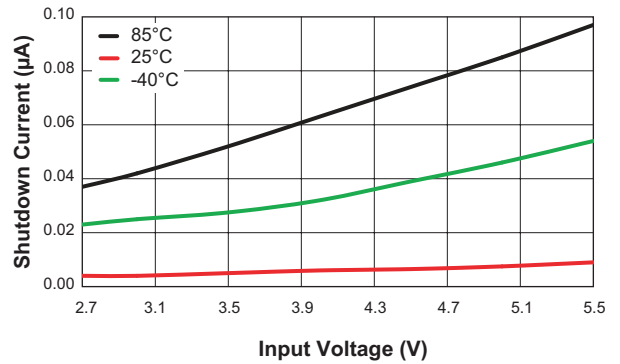

**Efficiency vs. Output Current**  
(R<sub>SET</sub> = 10KΩ, L = 10µH, 8 LEDs)

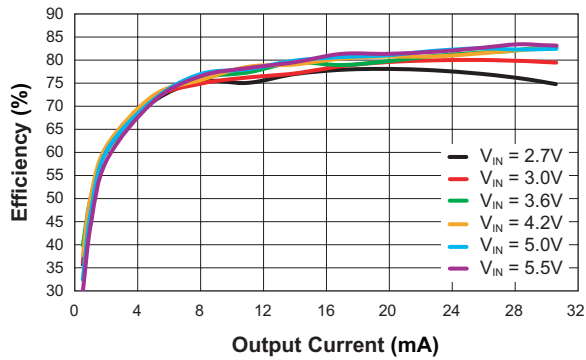

**LED Current Accuracy vs. S<sup>2</sup>C**  
(V<sub>IN</sub> = 3.6V, L = 10µH)

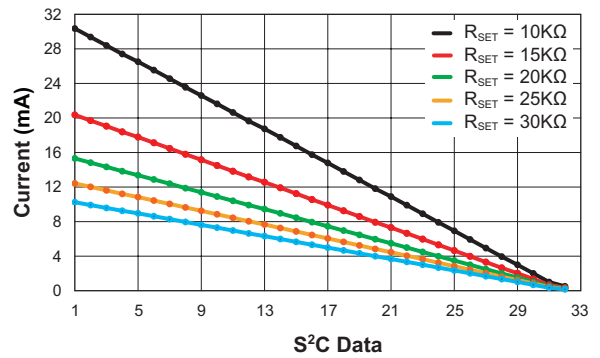

**LED Current Accuracy vs. Input Voltage**  
(V<sub>IN</sub> = 3.6V, R<sub>SET</sub> = 15KΩ)

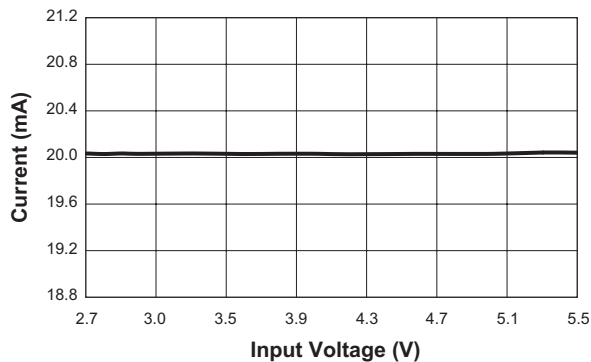

**Startup Time vs. C<sub>COMP</sub>**  
(V<sub>IN</sub> = 3.6V; I<sub>LED</sub> = 31mA; 8 LEDs)

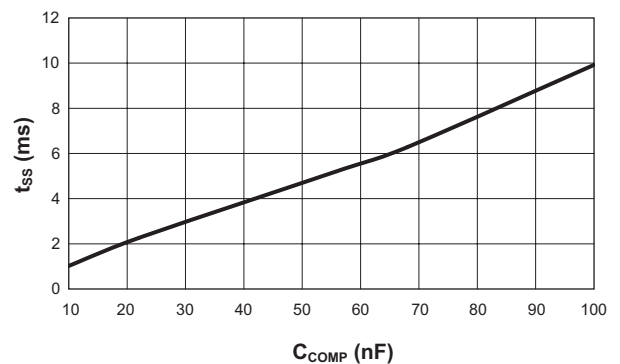

## Serial LED Driver with Filtered PWM and 32-Step S2C Dimming Control

### Typical Characteristics

**LED Current Accuracy vs. Temperature**  
( $V_{IN} = 3.6V$ ,  $R_{SET} = 10k\Omega$ )

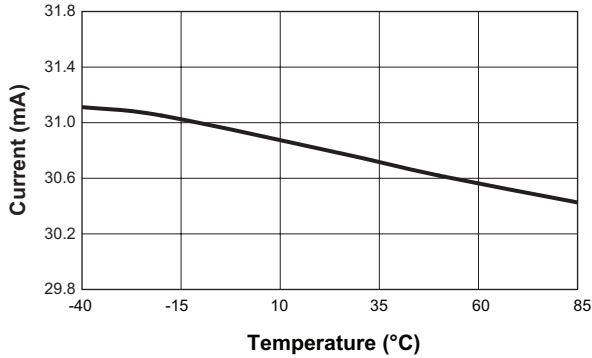

**LED Current Accuracy vs. Temperature**  
( $V_{IN} = 3.6V$ ,  $R_{SET} = 15k\Omega$ )

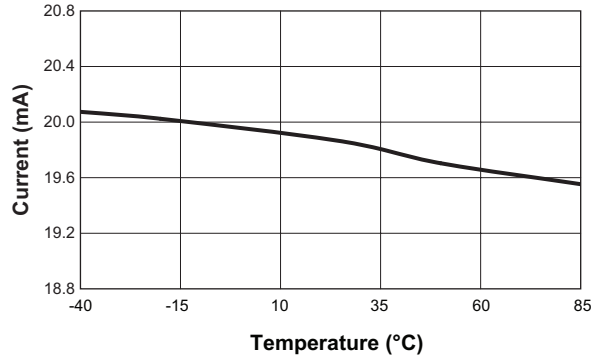

**EN Input High Threshold Voltage vs. Input Voltage**

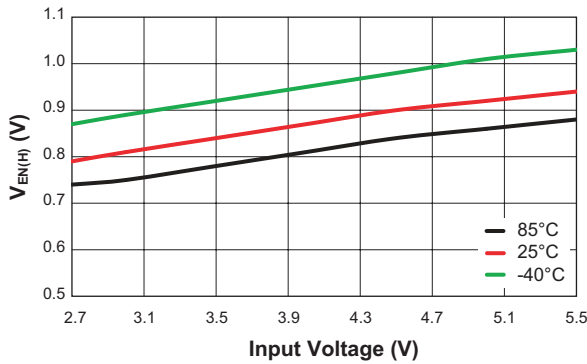

**EN Input Low Threshold Voltage vs. Input Voltage**

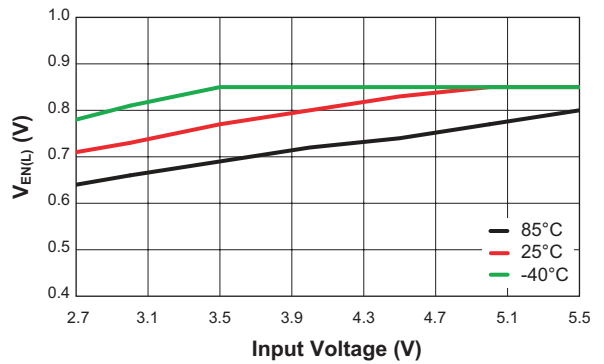

**PWM Input High Threshold Voltage vs. Input Voltage**

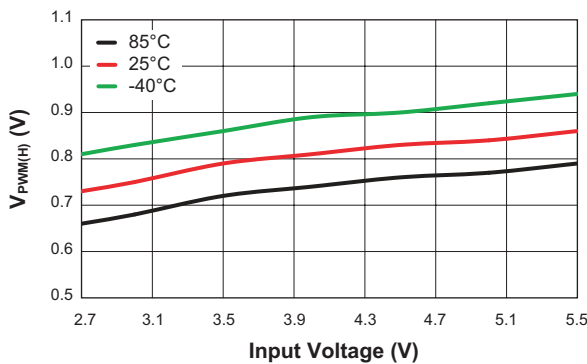

**PWM Input Low Threshold Voltage vs. Input Voltage**

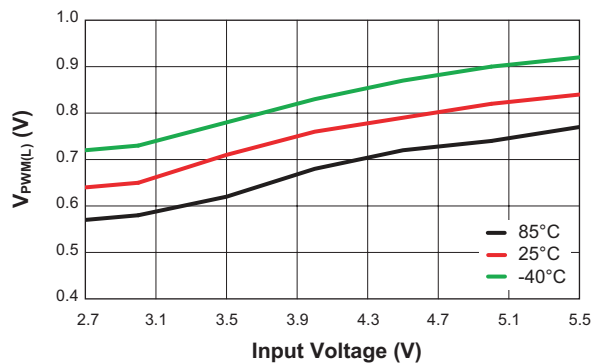

## Serial LED Driver with Filtered PWM and 32-Step S2C Dimming Control

### Typical Characteristics

**OVP High Threshold Voltage vs. Input Voltage**

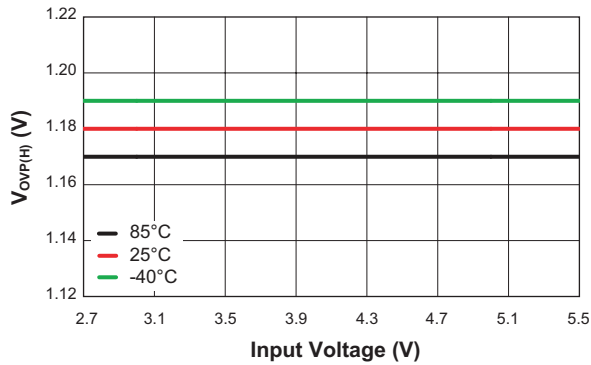

**OVP Low Threshold Voltage vs. Input Voltage**

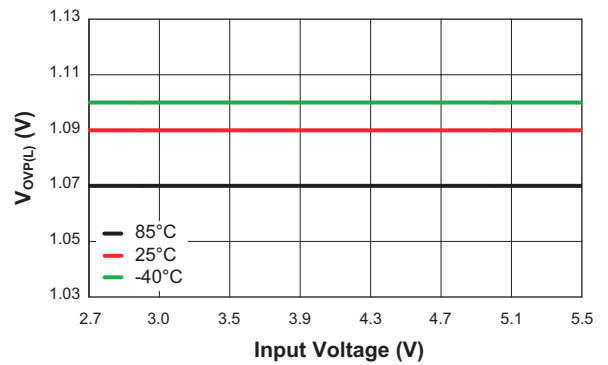

**NMOS  $R_{DS(ON)}$  vs. Input Voltage**

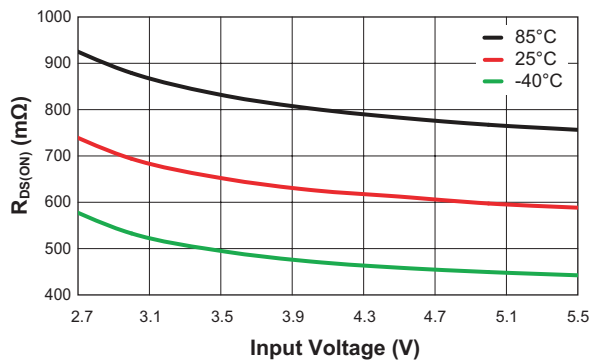

**Startup Waveform**

$(V_{IN} = 3.6V; C_{IN} = 4.7\mu F, C_{OUT} = 0.1\mu F, C_{COMP} = 56nF, R_{SET} = 10K\Omega, 8 \text{ WLEDs})$

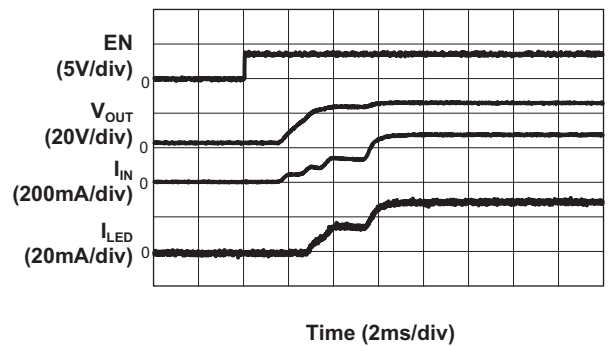

**Turn Off**

$(V_{IN} = 3.6V; C_{IN} = 4.7\mu F, C_{OUT} = 0.1\mu F, C_{COMP} = 56nF, R_{SET} = 10K\Omega, 8 \text{ WLEDs})$

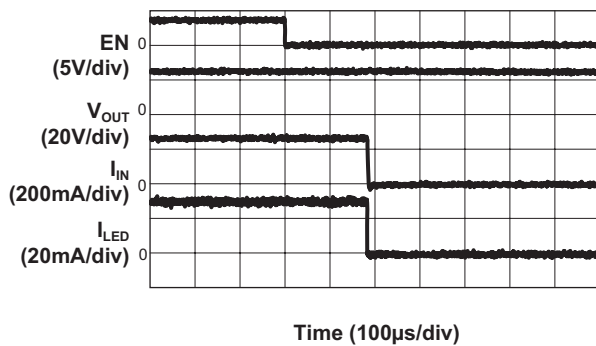

## Serial LED Driver with Filtered PWM and 32-Step S<sup>2</sup>C Dimming Control

### Typical Characteristics

**Operation Waveform**

( $V_{IN} = 3.6V$ ;  $C_{IN} = 4.7\mu F$ ,  $C_{OUT} = 0.1\mu F$ ,  
 $C_{COMP} = 56nF$ ,  $R_{SET} = 15K\Omega$ , 8 WLEDs)

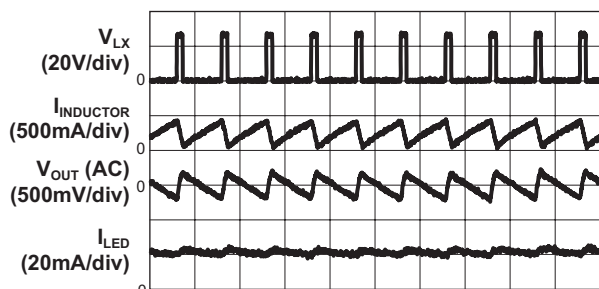

Time (1 $\mu s$ /div)

**Operation Waveform with 50kHz PWM Control**

( $V_{IN} = 3.6V$ ;  $C_{IN} = 4.7\mu F$ ,  $C_{OUT} = 0.1\mu F$ ,  $C_{COMP} = 56nF$ ,  
 $R_{SET} = 10K\Omega$ , PWM = 50kHz, 50% Duty Cycle, 8 WLEDs)

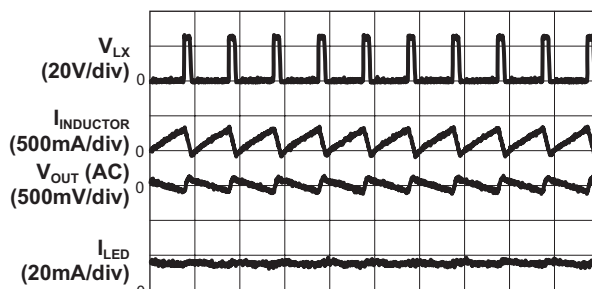

Time (1 $\mu s$ /div)

**LED Current Transition by PWM**

( $V_{IN} = 3.6V$ ;  $C_{IN} = 4.7\mu F$ ,  $C_{OUT} = 0.1\mu F$ ,  $C_{COMP} = 56nF$ ,  
 $R_{SET} = 10K\Omega$ , PWM = 10KHz, 31mA to 15mA, 8 LEDs)

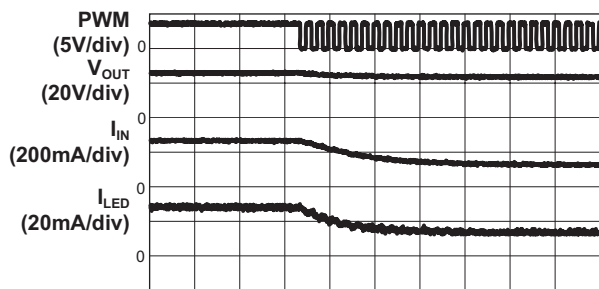

Time (400 $\mu s$ /div)

**LED Current Transition by PWM**

( $V_{IN} = 3.6V$ ;  $C_{IN} = 4.7\mu F$ ,  $C_{OUT} = 0.1\mu F$ ,  $C_{COMP} = 56nF$ ,  
 $R_{SET} = 10k\Omega$ , PWM = 10KHz, 15mA to 31mA, 8 LEDs)

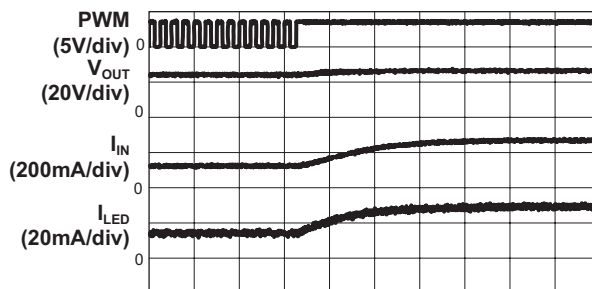

Time (400 $\mu s$ /div)

**LED Current Transient by S<sup>2</sup>Cwire**

( $V_{IN} = 3.6V$ ;  $C_{IN} = 4.7\mu F$ ,  $C_{OUT} = 0.1\mu F$ ,  $C_{COMP} = 56nF$ ,  
 $R_{SET} = 10K\Omega$ , S<sup>2</sup>Cwire Data 1 to 16, 8 LEDs)

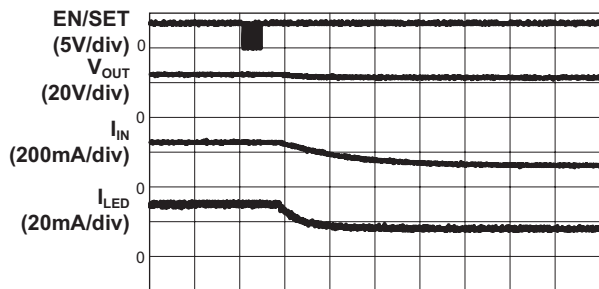

Time (400 $\mu s$ /div)

**LED Current Transient by S<sup>2</sup>Cwire**

( $V_{IN} = 3.6V$ ;  $C_{IN} = 4.7\mu F$ ,  $C_{OUT} = 0.1\mu F$ ,  $C_{COMP} = 56nF$ ,  
 $R_{SET} = 10K\Omega$ , S<sup>2</sup>Cwire Data 16 to 1, 8 LEDs)

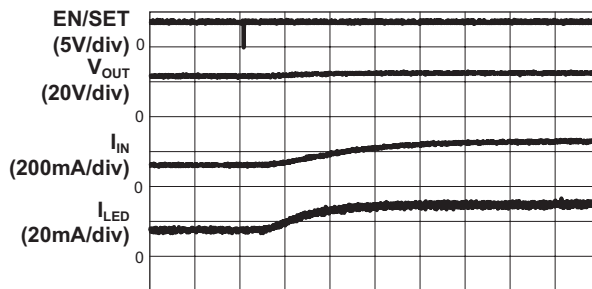

Time (400 $\mu s$ /div)



**Serial LED Driver with Filtered PWM and 32-Step S2C Dimming Control**

**Functional Block Diagram**

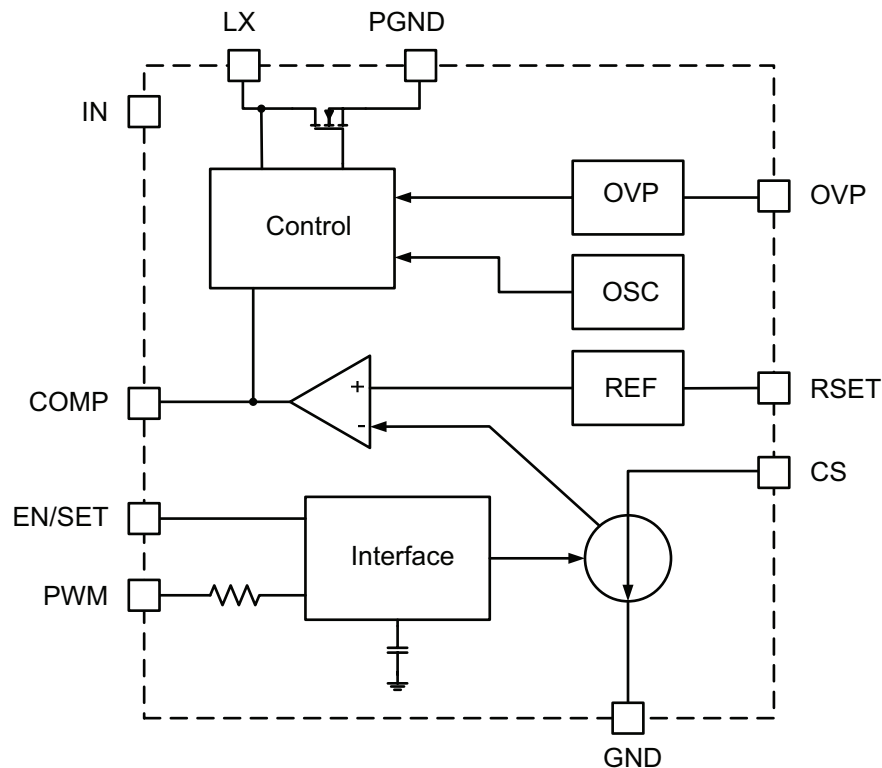

**Functional Description**

The AAT1402 is a high frequency current mode controlled step-up (boost) converter LED driver. The device utilizes a single current sink to regulate the LED current by controlling the output voltage. The wide voltage range is suitable for single cell Li-ion / Li-polymer battery applications. The internal current sink is programmed by an external resistor to a current from 10mA to 31mA. The minimum output voltage must be greater than the input voltage. The AAT1402 is capable of driving up to 8 series connected LEDs with currents up to 31mA.

The over-voltage protection function protects the boost converter from open circuit LED string faults. The over-temperature function protects the converter if an over-temperature fault occurs. The AAT1402 will recover to normal operation automatically when the OVP or OTP fault is removed.

**Soft Start / Enable**

The AAT1402 is enabled by EN/SET pulled to high after power on with a certain delay time. Soft start limits the current surge seen at the input and eliminates output voltage overshoot. When ENSET is pulled low the AAT1402 enters a low-power, non-switching state. The total input current during shutdown is less than 1µA. The external Schottky diode makes  $V_{OUT}$  equal to the level of  $V_{IN}$  during shutdown. The diode consumes a small amount of additional input current depending on the OVP resistor divider value.

**Over-Temperature Protection**

Thermal protection disables the AAT1402 when internal dissipation becomes excessive. Thermal protection disables the power MOSFET. The junction over-temperature threshold is 155°C with 15°C of temperature hysteresis. The output voltage automatically recovers when the over-temperature fault condition is removed.

## Serial LED Driver with Filtered PWM and 32-Step S2C Dimming Control

### Over-Voltage Protection

Over-voltage protection prevents damage to the AAT1402 LX pin during open-circuit or high output voltage conditions. An over-voltage event is defined as a condition where the voltage on the OVP pin exceeds the over-voltage protection threshold ( $V_{OVP-T}$ ). When  $V_{OVP}$  has reached the threshold limit, the converter stop switching and the output voltage decays. Switching resumes when the lower hysteresis limit of  $V_{OVP}$  is reached, thereby maintaining an average output voltage between the upper and lower OVP thresholds.

### LED Current Setting

The maximum LED current is determined by the  $R_{SET}$  resistor value. With a fixed 1.2V voltage on  $R_{SET}$ , the LED maximum current is a linear ratio to the current flowing through  $R_{SET}$ .

$$I_{LED} = \frac{V_{SET}}{R_{SET}} \cdot 258$$

The LED dimming is controlled via one of two options, either using the 32-step S<sup>2</sup>Cwire single-wire interface via the EN/SET pin or PWM control with varied duty cycle up to 100kHz frequency. 32 S<sup>2</sup>Cwire rising-edge steps set the LED current from 100% to 2% percentage of the maximum LED current value when PWM control is disabled by pulling the PWM pin high. S<sup>2</sup>Cwire can also be used to set maximum LED current along with a PWM signal to dim the LED lighting from 100% to 1% of duty cycle.

### S<sup>2</sup>Cwire™ Serial Interface

The LED current magnitude can be controlled by the EN/SET pin using the S<sup>2</sup>Cwire interface. The interface records rising edges of the EN/SET pin and decodes them into 32 individual current level settings. Code 1 is full scale (maximum LED current), and Code 32 is 2% of the full scale. The modulo 32 interface wraps states back to state 1 after the 32nd clock. The counter can be clocked at speeds up to 1MHz, so intermediate states are not visible. The first rising edge of EN/SET enables the IC and initially sets the output LED current to full scale after  $500\mu s$   $t_{LAT}$ . Once the final clock cycle is input for the desired brightness level, the EN/SET pin should be held high to maintain the device output current at the programmed level. The device is disabled  $500\mu s$  after the EN/SET pin enters a logic low state. The EN/SET timing is designed to accommodate a wide range of data rates from 20kHz to 1MHz.

After the first rising edge of EN/SET, the boost converter is enabled and reaches full capacity after the soft-start time. Exact counts of clock pulses for the desired current level should be entered on the EN/SET pin with a single burst of clocks. The counter refreshes each time a new clock input to the EN/SET pin is detected. A constant current is maintained as long as EN/SET remains in a logic high state. To save power, the boost converter is switched off after EN/SET has remained in the low state for at least the  $t_{OFF}$  timeout period as shown in Figure 1.

### S<sup>2</sup>Cwire Serial Interface Timing

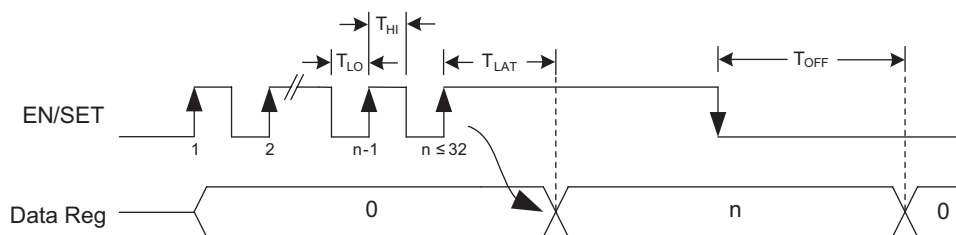

Figure 1: S<sup>2</sup>Cwire Timing Diagram.

## Serial LED Driver with Filtered PWM and 32-Step S<sup>2</sup>C Dimming Control

### Application Information

#### LED Current Setting

The maximum LED current is determined by value of the external resistor  $R_{SET}$  from 10mA to 31mA. The value of  $R_{SET}$  is determined by the voltage of  $R_{SET}$  and the LED current, and can be calculated by:

$$R_{SET} = \frac{V_{SET} \cdot 258}{I_{LED}}$$

Where  $V_{SET} = 1.2V$ . Table 1 lists examples of standard 1% metal film  $R_{SET}$  values for different maximum LED current requirements.

Maximum LED Current (mA)	$R_{SET}$ (k $\Omega$ )
31	10
20	15
15	20
12	25
10	30

**Table 1: Examples of Standard 1%  $R_{SET}$  Values for Setting Maximum LED Current Levels.**

LED current dimming is controlled either via the S<sup>2</sup>Cwire single-wire interface through the EN/SET pin in 32 steps or via PWM control with varied duty cycle up to 100kHz frequency. The S<sup>2</sup>Cwire interface programs the LED current from the maximum LED current set by  $R_{SET}$  to 2% of the maximum LED current as shown in Table 2.

S <sup>2</sup> Cwire Data	LED Current (% $I_{MAX}$ )	S <sup>2</sup> Cwire Data	LED Current (% $I_{MAX}$ )
1	100	17	48
2	97	18	45
3	94	19	42
4	90	20	39
5	87	21	35
6	84	22	32
7	81	23	29
8	77	24	26
9	74	25	23
10	71	26	19
11	68	27	16
12	65	28	13
13	61	29	10
14	58	30	6
15	55	31	3
16	52	32	2

**Table 2: S<sup>2</sup>Cwire Dimming Control Current Settings.**

Figure 2 illustrates the LED current value at different S<sup>2</sup>Cwire code settings when  $R_{SET}$  is 15k $\Omega$  with a maximum LED current of 20mA.

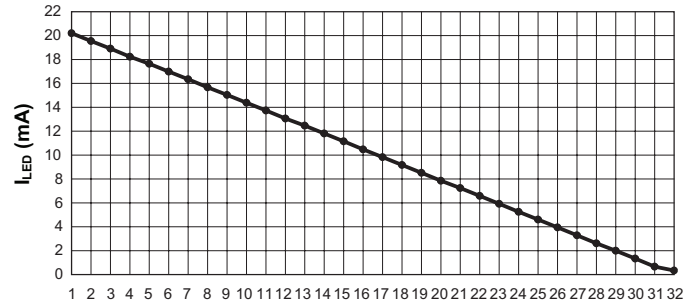
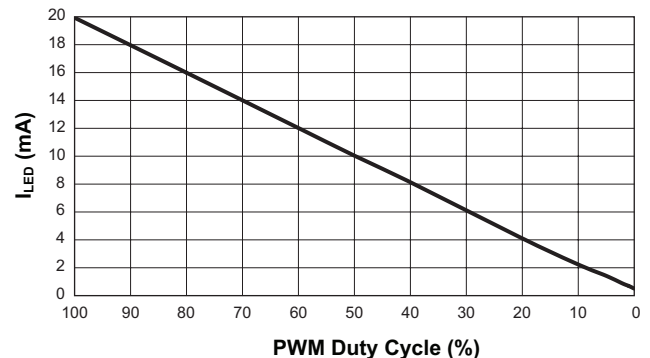

**Figure 2: S<sup>2</sup>Cwire Dimming Control at Maximum LED Current (20mA max).**

#### Filtered PWM Dimming

The AAT1402 provides a PWM input as an additional means of providing dimming control for CABC applications. The LED current reduces percentage linearly as the duty cycle decreasing. Frequencies of up to 100kHz can be applied. To avoid output flicker and noise, the input control PWM frequency is filtered by the low pass filter composed of the error amplifier and the external compensation capacitor.

Figure 3 shows the LED current dimming controlled by varying the PWM duty cycle at  $R_{SET} = 15k\Omega$ .



**Figure 3: Filtered PWM Dimming Duty Cycle vs. Maximum LED Current (20mA max).**

## Serial LED Driver with Filtered PWM and 32-Step S2C Dimming Control

### Capacitor Selection

A compensation capacitor  $C_{COM}$  is used for step-up converter loop compensation, soft startup time control, and PWM digital signal filtering. Loop compensation requires matching values for  $C_{COM}$ ,  $C_{OUT}$ ,  $I_{LED}$ , and  $V_{OUT}$ :

$$\frac{C_{OUT}}{C_{COM}} < \frac{I_{LED}}{30 \cdot 10^{-6} \cdot V_{OUT}}$$

The AAT1402 can drive up to 8 white LEDs with forward voltages up to 4V each. In a worst case with  $V_F$  of 4V, a  $C_{OUT}$  value of 0.1 $\mu$ F, and LED maximum current of 20mA, the value of  $C_{COM}$  should be higher than 4.8nF.

$$C_{COM} > \frac{C_{OUT} \cdot 30 \cdot V_{OUT}}{I_{LED}} \text{ (nF)} = \frac{0.1 \cdot 30 \cdot 32}{20} \text{ (nF)} = 4.8\text{nF}$$

A higher value for  $C_{COM}$  lengthens the soft startup time. The relationship between  $C_{COM}$  and startup time is almost linear, with startup time  $\times 10^5$  magnification of  $C_{COM}$ ; thus 56nF  $C_{COM}$  leads to a soft startup time of 5.6ms. Table 3 gives several examples of minimum  $C_{COM}$  values at different  $C_{OUT}$  and  $I_{LED}$  and the step-up converter's operation stable. Values of 56nF for  $C_{COM}$  and 0.1 $\mu$ F for  $C_{OUT}$  are suitable in most cases.

$I_{LED}$ (mA)	$C_{OUT}$ ( $\mu$ F)	$V_{OUT}$ (V)	$C_{COM\_MIN}$ (nF)
31	0.1	32	3.2
31	1	32	32
20	0.1	32	4.8
20	1	32	48
10	0.1	32	9.6
10	1	32	96

**Table 3: Minimum  $C_{COM}$  Values vs.  $I_{LED}$  and  $C_{OUT}$  (Step-Up Converter Operation Stable).**

Multi-layer ceramic (MLC) capacitors provide small size and adequate capacitance, low parasitic equivalent series resistance (ESR) and equivalent series inductance (ESL), and are well suited for use as input, output and compensation capacitors in the AAT1402 step-up converter LED driver application. MLC capacitors of type X7R or X5R are recommended to ensure good capacitance stability over the full operating temperature range. A 4.7 $\mu$ F/6.3V input capacitor is recommended and a 0.1 $\mu$ F/50V output capacitor is suitable as noted above. Table 4 lists some recommended capacitors for use with the AAT1402.

### Inductor Selection

Inductor value, saturation current and DCR is most important parameter in selecting an inductor for AAT1402.

The suitable inductance range for the AAT1402 is 4.7 $\mu$ H to 22 $\mu$ H. Higher inductance lowers the step-up converter's RMS current value. Together with lower DCR value of the inductor, it makes the total inductor power loss become much lower. Considering inductor size and cost, 10 $\mu$ H inductance is most suitable. Figure 4 illustrates AAT1402 efficiency at different inductance with similar DCR value.

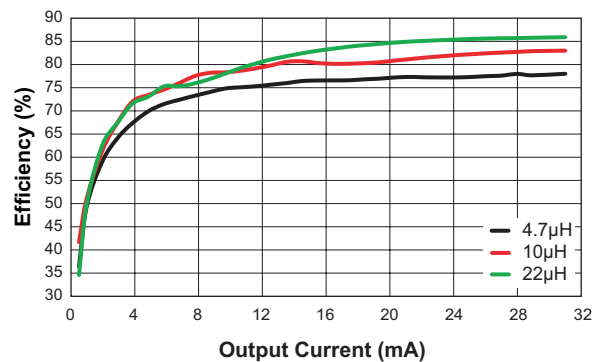

**Figure 4: AAT1402 Efficiency at Different Inductance with Similar DCR ( $V_{IN} = 3.6V$ ).**

Manufacturer	Part Number	Value ( $\mu$ F)	Voltage (V)	Temperature Range	Case Size
Murata	GRM188R60J475K	4.7	6.3	X5R	0603
	GRM188R71H104KA93	0.1	50	X7R	0603

**Table 4: Examples of AAT1402 Input and Output Capacitor Selection.**

## Serial LED Driver with Filtered PWM and 32-Step S2C Dimming Control

Considering the inductor copper loss, the inductor DCR value together with the RMS current value flowing through the inductor leads to inductor conduction loss and also affects total efficiency. Larger DCR leads to larger conduction loss and decreases total efficiency. The inductor conduction loss can be estimated as shown in the equation:

$$P_{L\_LOSS} = I_{L\_RMS}^2 \cdot DCR$$

$$= \frac{1}{3} \cdot (I_{L\_MAX}^2 + I_{L\_MIN}^2 + I_{L\_MAX} \cdot I_{L\_MIN}) \cdot DCR$$

$I_{L\_MAX}$  and  $I_{L\_MIN}$  are the inductor peak current and minimum current. Figure 5 shows DCR effects on efficiency with a 10μH inductor.

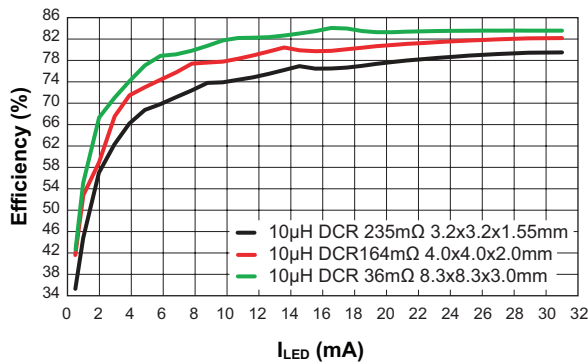

**Figure 5: Inductor DCR Effects on Total Efficiency with 10μH at 3.6V  $V_{IN}$ .**

Inductor saturation current is also a key parameter in selecting an inductor. For the step-up converter, the peak inductor current is the DC input current plus half the inductor peak-to-peak current ripple.

DC input current:

$$I_{IN} = \frac{V_{OUT} \cdot I_{LED}}{V_{IN} \cdot \eta}$$

Inductor peak-to-peak current ripple:

$$I_{L\_PP} = \frac{V_{IN} \cdot (V_{OUT} - V_{IN})}{V_{OUT} \cdot L \cdot f}$$

Inductor peak current:

$$I_{L\_PEAK} = I_{IN} + \frac{I_{L\_PP}}{2} = \frac{V_{OUT} \cdot I_{LED}}{V_{IN} \cdot \eta} + \frac{V_{IN} \cdot (V_{OUT} - V_{IN})}{2 \cdot V_{OUT} \cdot L \cdot f}$$

For example, for a white LED with 3.2V  $V_F$  and 20mA current at 81% efficiency with  $V_{IN}$  less than 3.6V, the inductor peak current is

$$I_{L\_PEAK} = \frac{3.2 \cdot 8 \cdot 0.02}{3.6 \cdot 0.81} + \frac{3.6 \cdot (3.2 \cdot 8 - 3.6)}{2 \cdot 3.2 \cdot 8 \cdot 10\mu \cdot 1M} = 330mA$$

Table 5 gives some examples of recommended inductors for use with the AAT1402.

### OVP Setting

Over-voltage protection is designed to protect the step-up converter from a LED string open fault. The OVP threshold is 1.2V. For 8 white LEDs with  $V_F$  up to 4V, the resistor divider values for R1 and R2 can be calculated by:

$$R_1 = \left( \frac{V_{OUT}}{V_{OVP\_TH}} - 1 \right) \cdot R_2$$

Higher resistor divider values decrease the power loss on the resistors. The total resistor value for 32V  $V_{OUT}$  should be less than 3.2MΩ for better noise immunity. Values of 1.2MΩ for resistor R1 and 47kΩ for resistor R2 are recommended.

Manufacturer	Part Number	Inductance (μH)	Maximum DC $I_{SAT}$ Current (mA)	DCR (mΩ, typ)	Size (mm) LxWxH	Type
Sumida	CDRH3D18-100	10	900	164	4.0x4.0x2.0	Shielded
	CDRH3D23-220	22	550	219	3.9x3.9x2.5	Shielded
Murata	LQH44PN100MP0L	10	1150	160	4.0x4.0x1.65	Non-shielded
	LQH44PN220MP0L	22	800	370	4.0x4.0x1.65	Non-shielded
Coilcraft	EPL2014-103MLC	10	600	440	2.1x2.2x1.0	Shielded
	LPS4012-223MLC	22	790	600	4.1x4.1x1.2	Shielded
Coiltronics	SD18-100-R	10	982	158	5.8x5.8x1.8	Shielded

**Table 5: Example of AAT1402 Inductor Selection.**

**Serial LED Driver with Filtered PWM and 32-Step S2C Dimming Control****Rectifier Diode Selection**

An external rectifier diode is required for the non-synchronous step-up converter. A low  $V_F$  Schottky diode is recommended. The diode voltage rating should be higher than the OVP voltage. For an AAT1402 driving 8 white LEDs with up to 4V forward voltage, the diode voltage rating should be higher than 32V. Select a diode with DC rated current equal to the input current to allow an adequate margin for safe use.

**Printed Circuit Board Layout Recommendations**

For best performance of the AAT1402, the following guidelines should be followed when designing the PCB layout:

1. Make the power trace as short and wide as possible, including the input/output power lines and switching node, etc.
2. Make sure the ground bump connected to the printed circuit board with large copper area for better thermal dissipation.
3. Put the input and output capacitor close to the IC as close as possible to get the best filter result.

Manufacturer	Part Number	Maximum DC Blocking Voltage $V_R$ (V)	Maximum DC Forward Current $I_F$ (mA)	Non-repetitive Peak Forward Surge Current $I_{FSM}$ (A)	Forward Voltage $V_F$ (V)	Case	Size WxLxH (mm)
Diodes	SDM20U40	40	250	1.0	0.37@20mA	SOD523	0.9x1.7x0.65
	DFLS160	60	1000	5.0	0.5@1A	PowerDI 123	1.93x3.0x1.0
TSC	SS15L	50	1100	30	0.51@0.5A	Sub SMA	1.9x3.8x1.43
	SS14L	40	1100	30	0.51@0.5A	Sub SMA	1.9x3.8x1.43

**Table 5: Example of Typical Rectifier Diodes.**

# AAT1402

## Serial LED Driver with Filtered PWM and 32-Step S2C Dimming Control

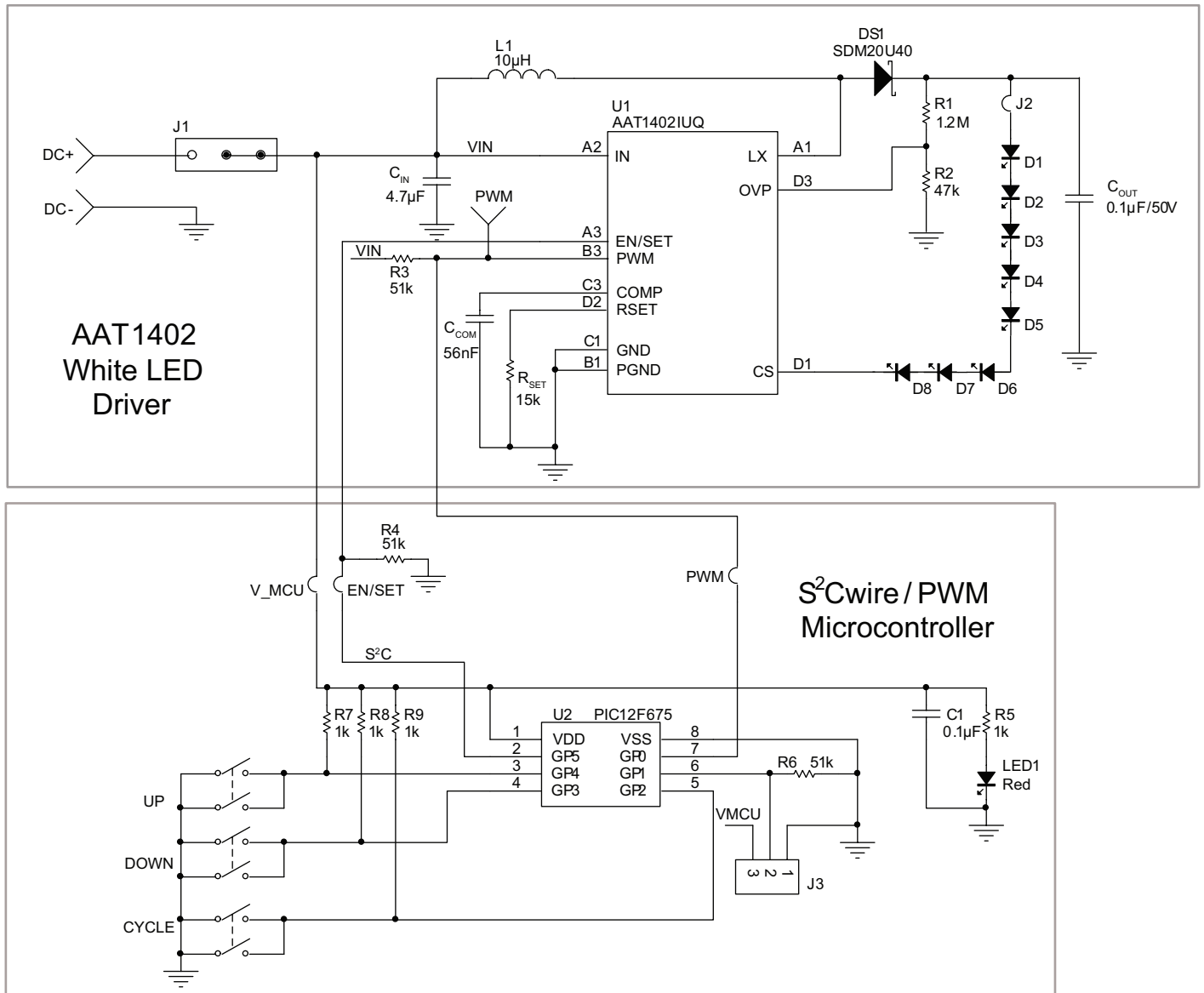
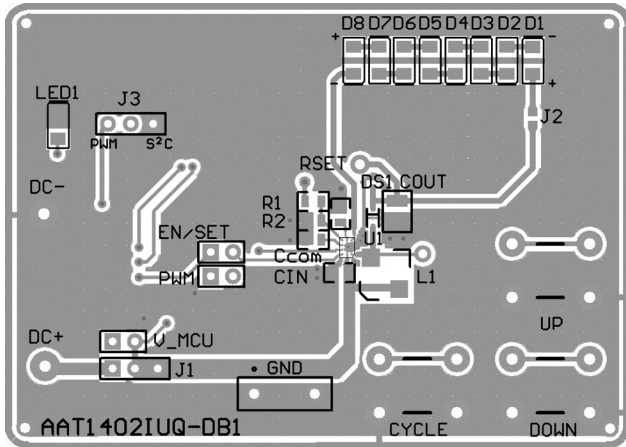

Figure 6: AAT1402 Evaluation Board Schematic.

# AAT1402

## Serial LED Driver with Filtered PWM and 32-Step S2C Dimming Control



**Figure 7: AAT1402 Evaluation Board Layout Top Layer.**

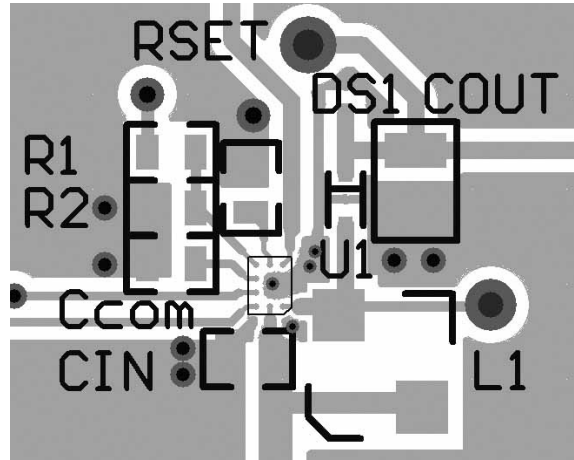

**Figure 8: AAT1402 Evaluation Board Layout Top Layer (detail).**

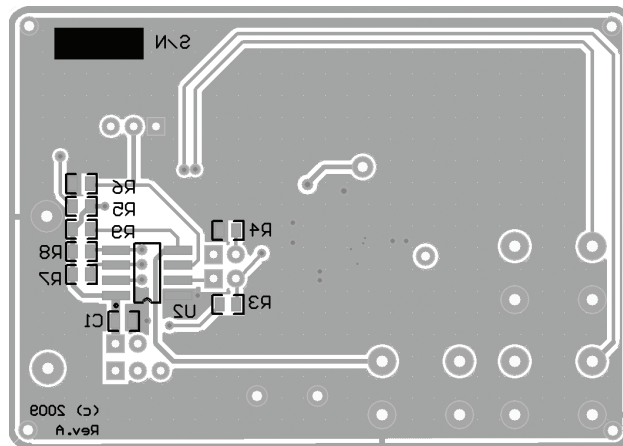

**Figure 9: AAT1402 Evaluation Board Layout Bottom Layer.**



**AAT1402****Serial LED Driver with Filtered PWM and 32-Step S2C Dimming Control**

Component	Part Number	Description	Manufacturer
U1	AAT1402IUQ	High Efficiency Serial LED Driver for 8 White LEDs	Skyworks
U2	PIC12F675	8-Pin Flash-Based 8-Bit CMOS Microcontrollers	Microchip
R1	RC0603FR-071M2L	Res 1.2M $\Omega$ 1/10W 1% 0603 SMD	Yageo
R2	RC0603FR-0747KL	Res 47k $\Omega$ 1/10W 1% 0603 SMD	
RSET	RC0603FR-0715KL	Res 15k $\Omega$ 1/10W 1% 0603 SMD	
R3, R4, R6	RC0603FR-0751KL	Res 51k $\Omega$ 1/10W 1% 0603 SMD	
R5, R7, R8, R9	RC0603FR-071KL	Res 1k $\Omega$ 1/10W 1% 0603 SMD	
CIN	GRM188R60J475K	Cap Ceramic 4.7 $\mu$ F 0603 X5R 6.3V 10%	Murata
COUT	GRM188R71H104K	Cap Ceramic 0.1 $\mu$ F 0603 X7R 50V 10%	
C1	GRM188R71C104K	Cap Ceramic 0.1 $\mu$ F 0603 X7R 16V 10%	
CCOM	GRM188R71C563K	Cap Ceramic 0.05 $\mu$ F 0603 X7R 16V 10%	
D1, D2, D3, D4, D5, D6, D7, D8	RS-0805UW	20mA White LED 0805	Realstar
DS1	SDM20U40	Surface Mount Schottky Barrier Diode	Diodes
L1	CDRH3D18-100NC	Power Inductor 10 $\mu$ H 0.9A SMD	Sumida
LED1	0805KRCT	Red LED 0805	HB
CYCLE, UP, DOWN	6*6*5	12V 50mA Pushbutton	E-LT

**Table 6: AAT1402 Evaluation Board Bill of Materials (BOM).**

## Serial LED Driver with Filtered PWM and 32-Step S2C Dimming Control

### Ordering Information

Package	Maximum # of LEDs	Interface	Marking	Part Number (Tape and Reel)
WLCSP-10	8	S <sup>2</sup> Cwire, Filtered PWM	H4YY	<b>AAT1402IUQ-T1</b>

 Skyworks Green™ products are compliant with all applicable legislation and are halogen-free. For additional information, refer to *Skyworks Definition of Green™*, document number SQ04-0074.

### Package Information

#### WLCSP-10

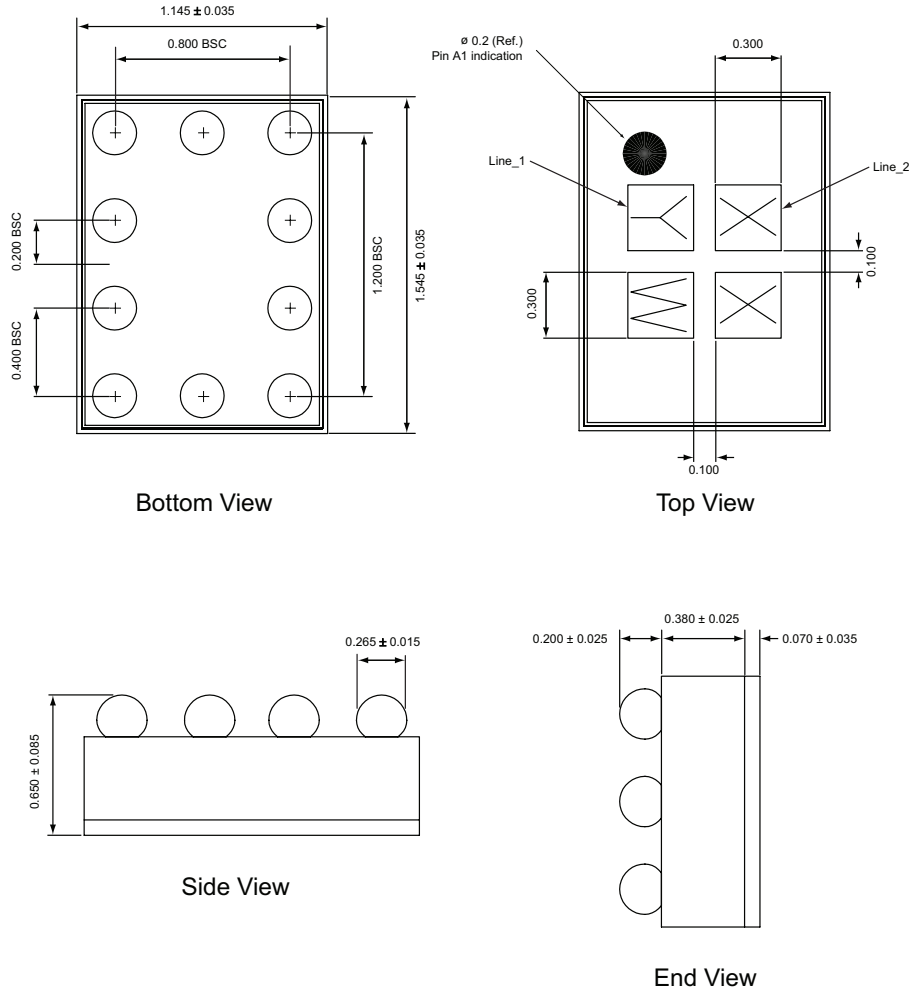

All dimensions in millimeters.

- YY = date code.
- Sample stock is generally held on part numbers listed in **BOLD**.

---

**Serial LED Driver with Filtered PWM and 32-Step S2C Dimming Control**

Copyright © 2012 Skyworks Solutions, Inc. All Rights Reserved.

Information in this document is provided in connection with Skyworks Solutions, Inc. ("Skyworks") products or services. These materials, including the information contained herein, are provided by Skyworks as a service to its customers and may be used for informational purposes only by the customer. Skyworks assumes no responsibility for errors or omissions in these materials or the information contained herein. Skyworks may change its documentation, products, services, specifications or product descriptions at any time, without notice. Skyworks makes no commitment to update the materials or information and shall have no responsibility whatsoever for conflicts, incompatibilities, or other difficulties arising from any future changes.

No license, whether express, implied, by estoppel or otherwise, is granted to any intellectual property rights by this document. Skyworks assumes no liability for any materials, products or information provided hereunder, including the sale, distribution, reproduction or use of Skyworks products, information or materials, except as may be provided in Skyworks Terms and Conditions of Sale.

THE MATERIALS, PRODUCTS AND INFORMATION ARE PROVIDED "AS IS" WITHOUT WARRANTY OF ANY KIND, WHETHER EXPRESS, IMPLIED, STATUTORY, OR OTHERWISE, INCLUDING FITNESS FOR A PARTICULAR PURPOSE OR USE, MERCHANTABILITY, PERFORMANCE, QUALITY OR NON-INFRINGEMENT OF ANY INTELLECTUAL PROPERTY RIGHT; ALL SUCH WARRANTIES ARE HEREBY EXPRESSLY DISCLAIMED. SKYWORKS DOES NOT WARRANT THE ACCURACY OR COMPLETENESS OF THE INFORMATION, TEXT, GRAPHICS OR OTHER ITEMS CONTAINED WITHIN THESE MATERIALS. SKYWORKS SHALL NOT BE LIABLE FOR ANY DAMAGES, INCLUDING BUT NOT LIMITED TO ANY SPECIAL, INDIRECT, INCIDENTAL, STATUTORY, OR CONSEQUENTIAL DAMAGES, INCLUDING WITHOUT LIMITATION, LOST REVENUES OR LOST PROFITS THAT MAY RESULT FROM THE USE OF THE MATERIALS OR INFORMATION, WHETHER OR NOT THE RECIPIENT OF MATERIALS HAS BEEN ADVISED OF THE POSSIBILITY OF SUCH DAMAGE.

Skyworks products are not intended for use in medical, lifesaving or life-sustaining applications, or other equipment in which the failure of the Skyworks products could lead to personal injury, death, physical or environmental damage. Skyworks customers using or selling Skyworks products for use in such applications do so at their own risk and agree to fully indemnify Skyworks for any damages resulting from such improper use or sale.

Customers are responsible for their products and applications using Skyworks products, which may deviate from published specifications as a result of design defects, errors, or operation of products outside of published parameters or design specifications. Customers should include design and operating safeguards to minimize these and other risks. Skyworks assumes no liability for applications assistance, customer product design, or damage to any equipment resulting from the use of Skyworks products outside of stated published specifications or parameters.

Skyworks, the Skyworks symbol, and "Breakthrough Simplicity" are trademarks or registered trademarks of Skyworks Solutions, Inc., in the United States and other countries. Third-party brands and names are for identification purposes only, and are the property of their respective owners. Additional information, including relevant terms and conditions, posted at [www.skyworksinc.com](http://www.skyworksinc.com), are incorporated by reference.